

FUTURE ARCHITECTURE FESTIVAL 27.09.2017

FORUM BASEL

URBAN SPACES FOR COMMUNAL LIVING

EXHIBITION AT SAM SCHWEIZERISCHES ARCHITEKTURMUSEUM



Alfredo Jaar, *Culture = Capital*, Art Basel Miami, 2014



FOOD FORUM
BASEL

CURATORIAL APPROACH
TOWARDS A COMMON ARCHITECTURE

COMMON ARCHITECTURE is the search for a common symbolic space defined through form.

COMMON ARCHITECTURE is Poor Architecture, in the words of Lina Bo Bardi:

“not in the sense of poverty, but in the sense of handicraft, expressing maximum communication and dignity through minor and humble means.”

COMMON PLACES
44 STRATEGIES FOR PUBLIC SPACE

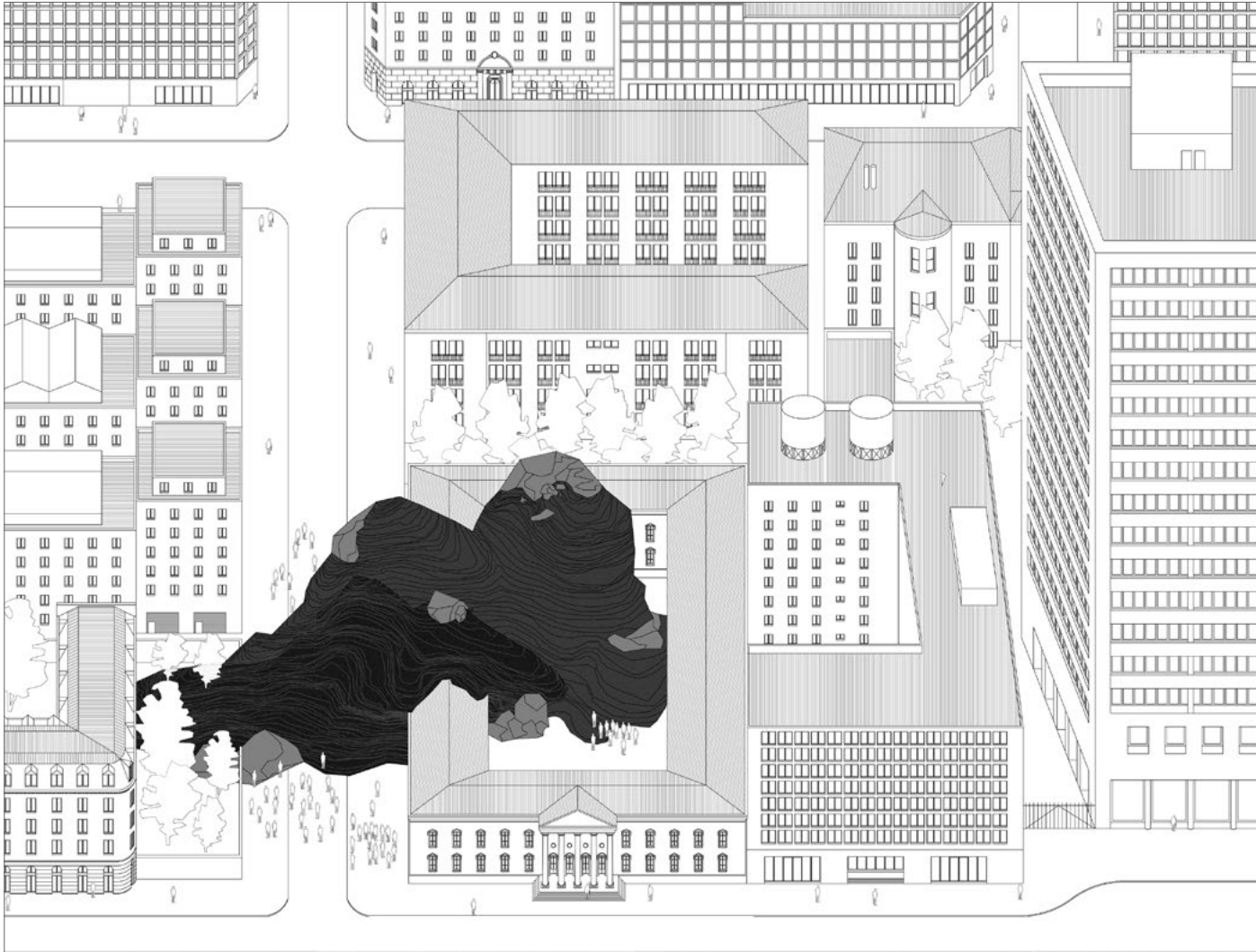

New Geographies, Pedro Correa

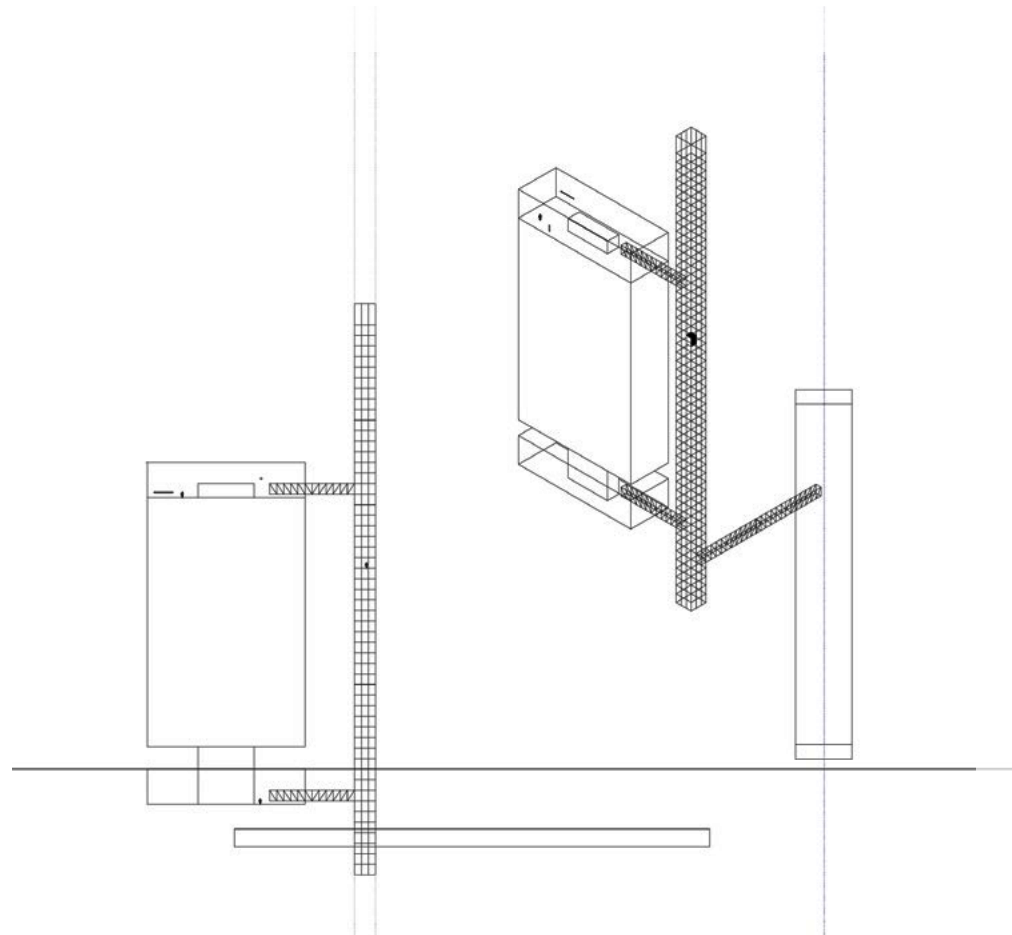

Observation Towers, Ciro Miguel & Bruna Canepa

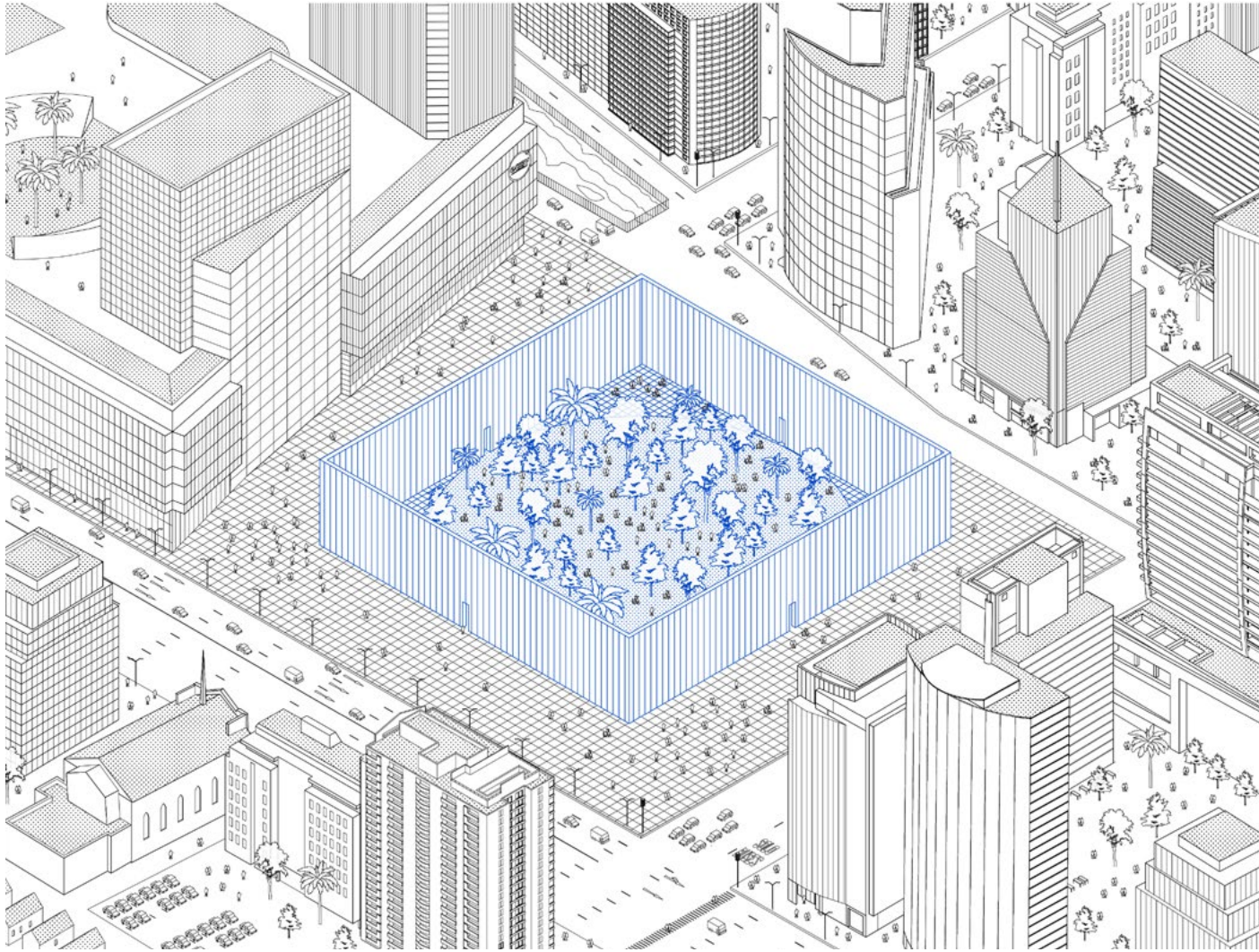

Case 05: Autonomous Squares - Containing commons

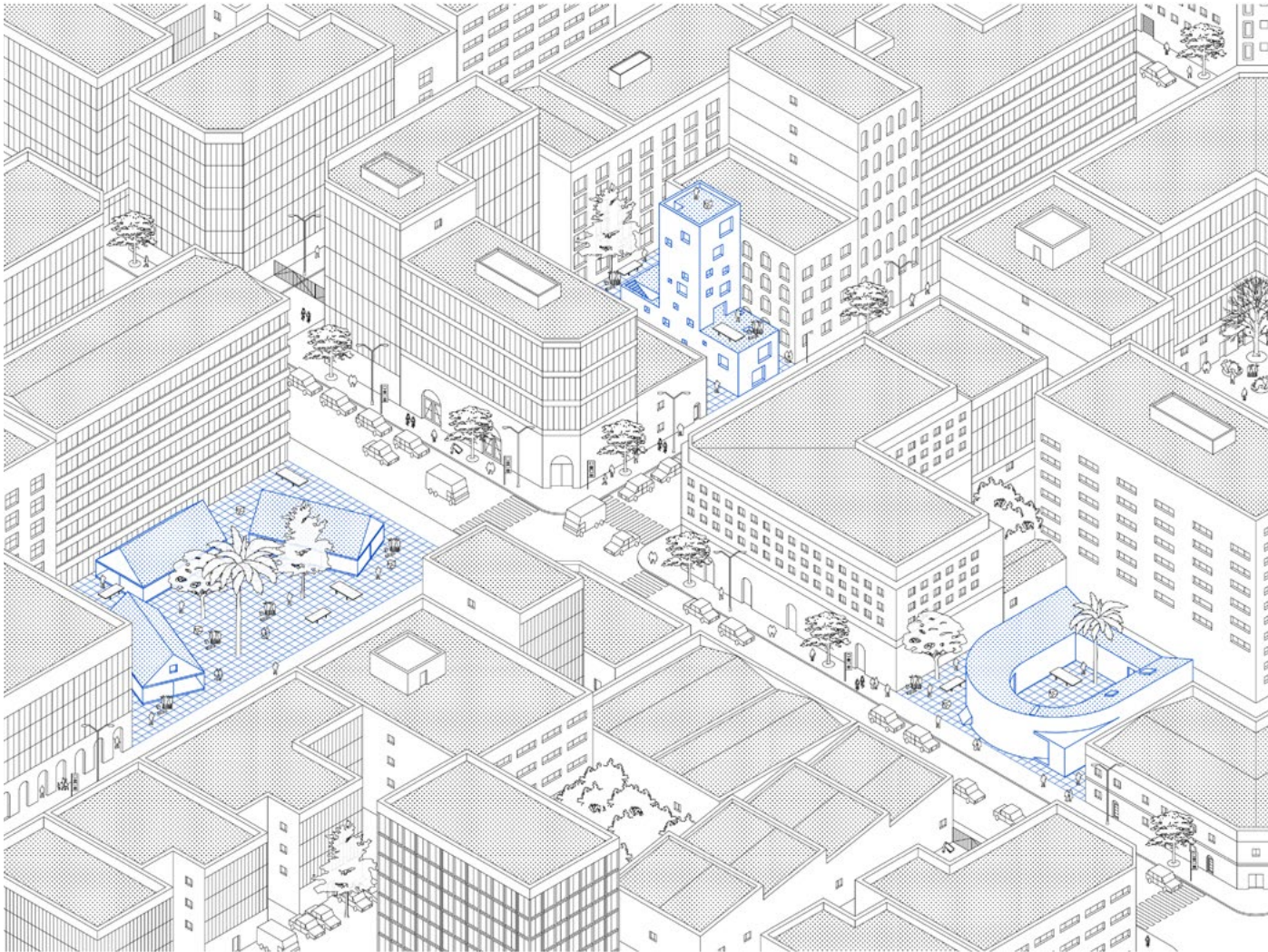

Case 13: Iconic Houses - Domestic architecture for all

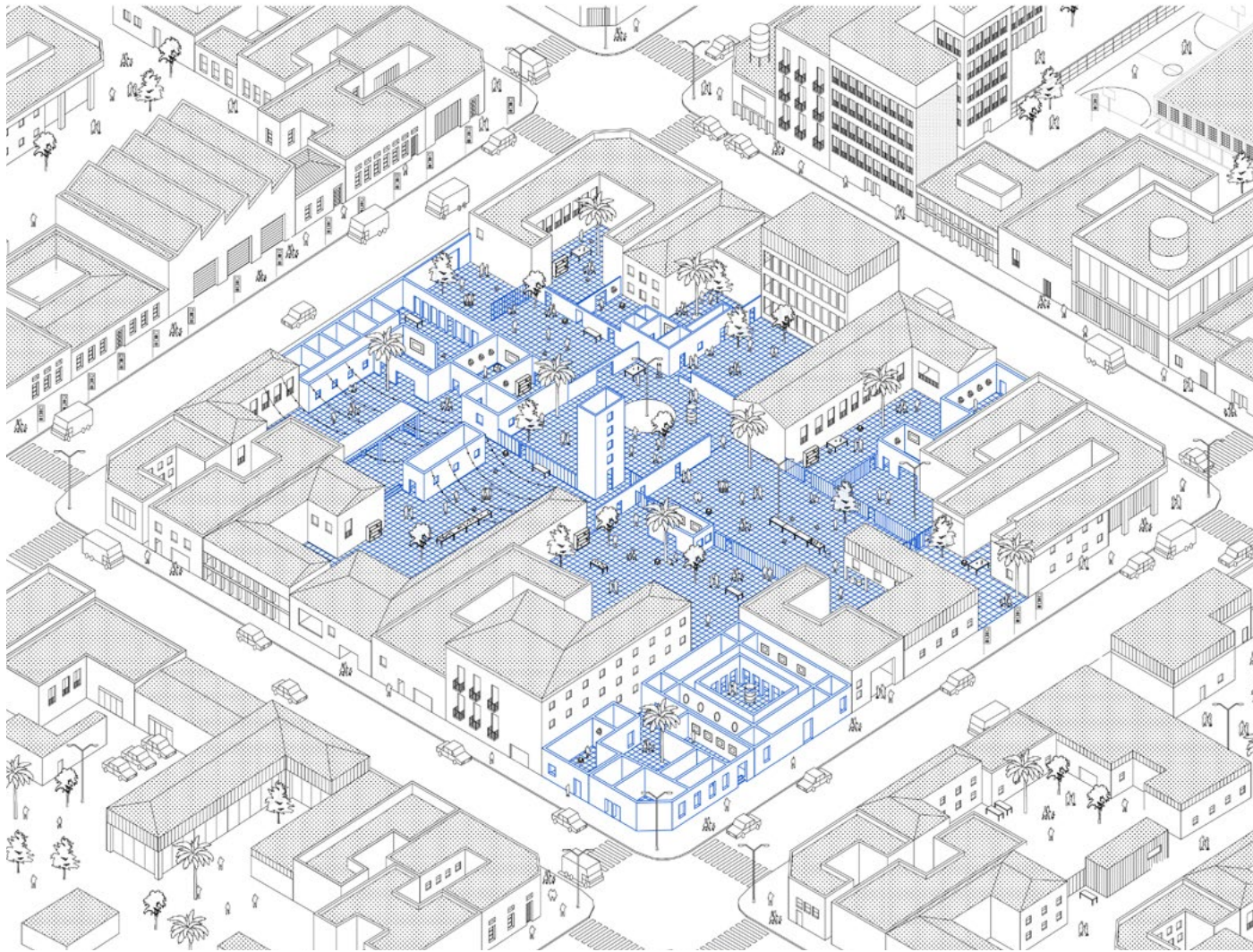

Case 04: Public Interiors - Open rooms for collective use



GATHERING BASEL
SIX STRATEGIES FOR PUBLIC SPACE



CONTRIBUTIONS BY:

CAESAR ZUMTHOR ARCHITEKTEN, FOCKETYN DEL RIO STUDIO, MANUEL HERZ ARCHITECTS,
RAHBARAN HÜRZELER ARCHITEKTEN, SCHEIBLER & VILLARD, VÉCSEY SCHMIDT ARCHITEKTEN

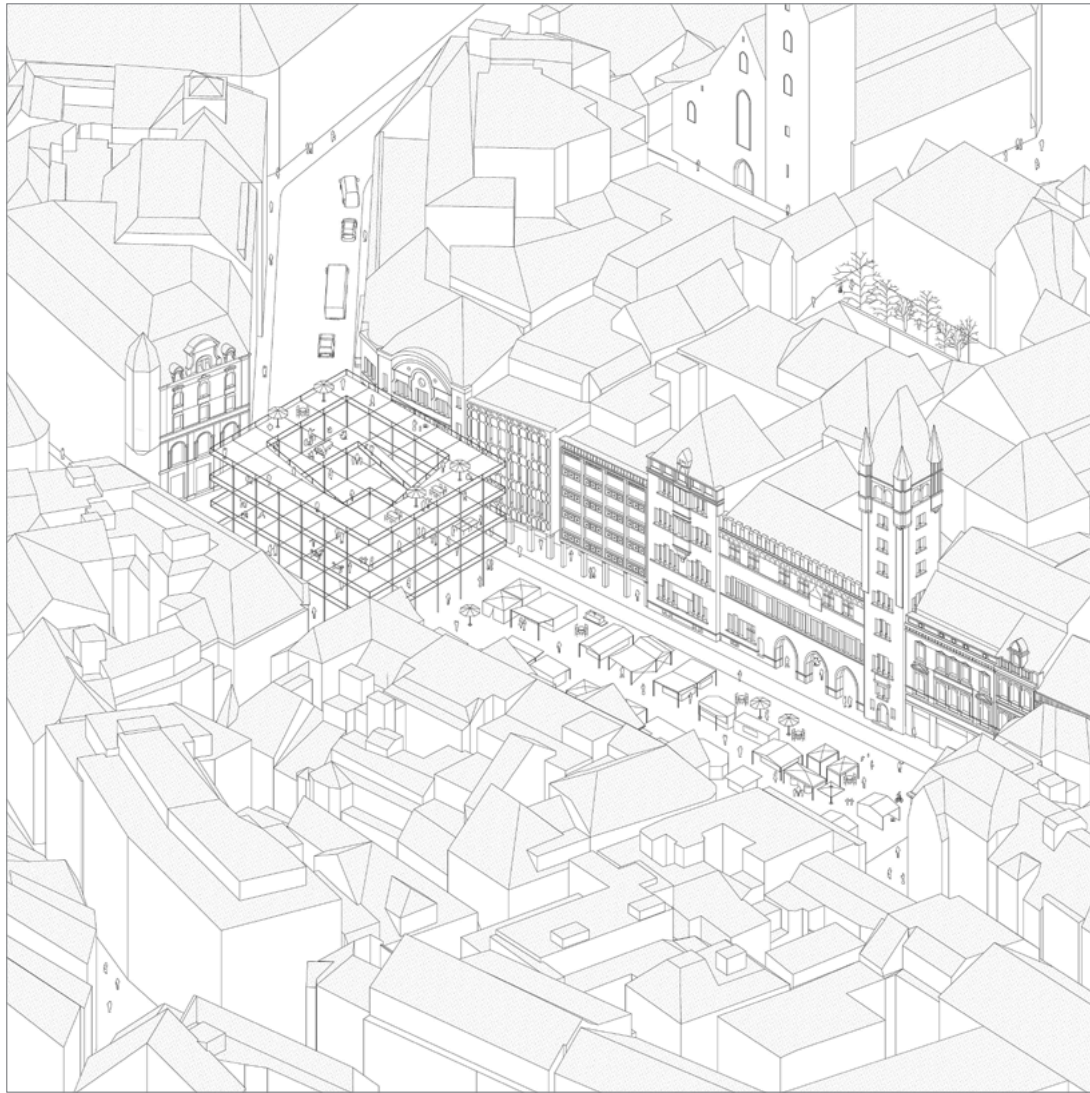

Multiplied square - A new public structure on Marktplatz, Caesar Zumthor Architekten

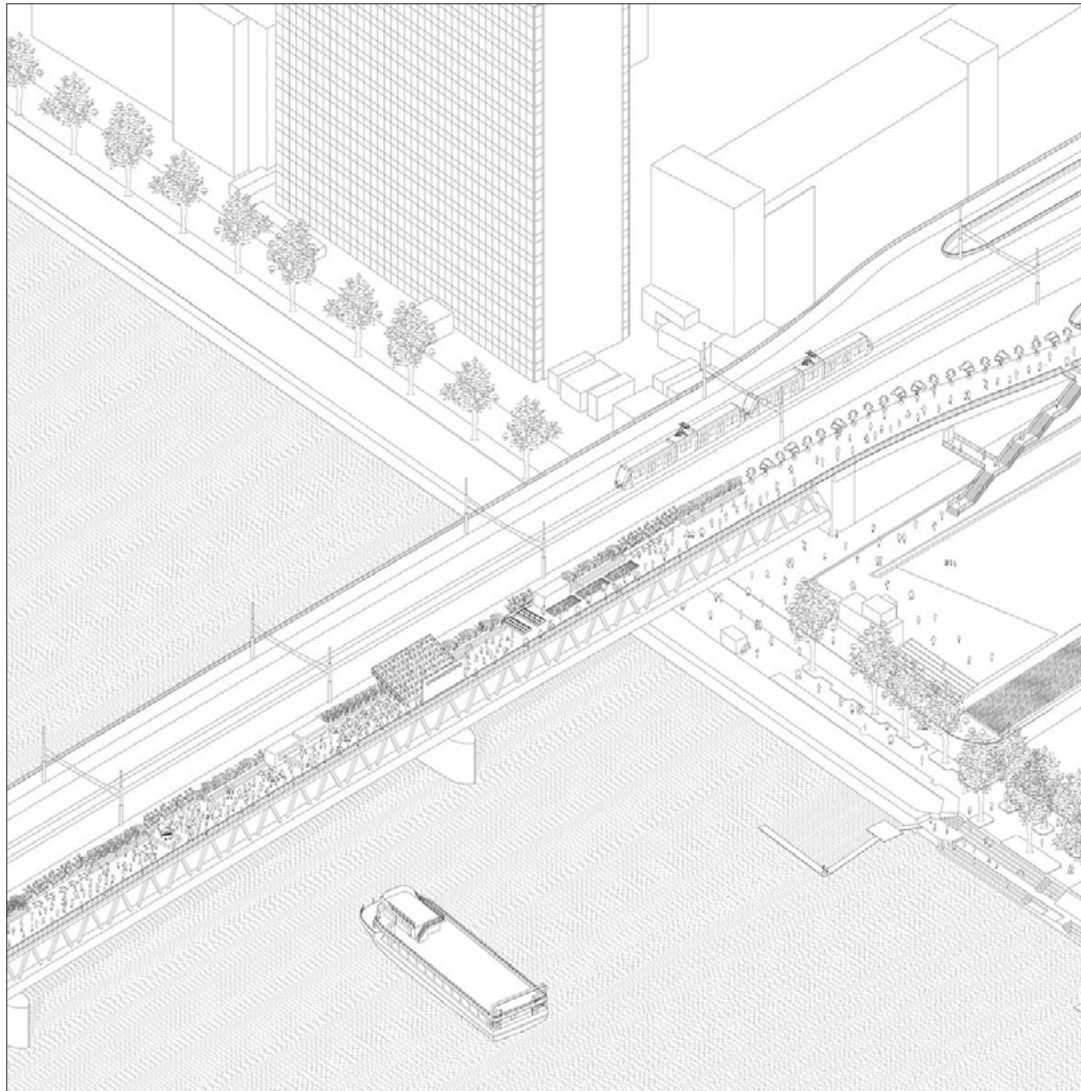

Dreirosenbrücke - A promise fulfilled, Manuel Herz Architects

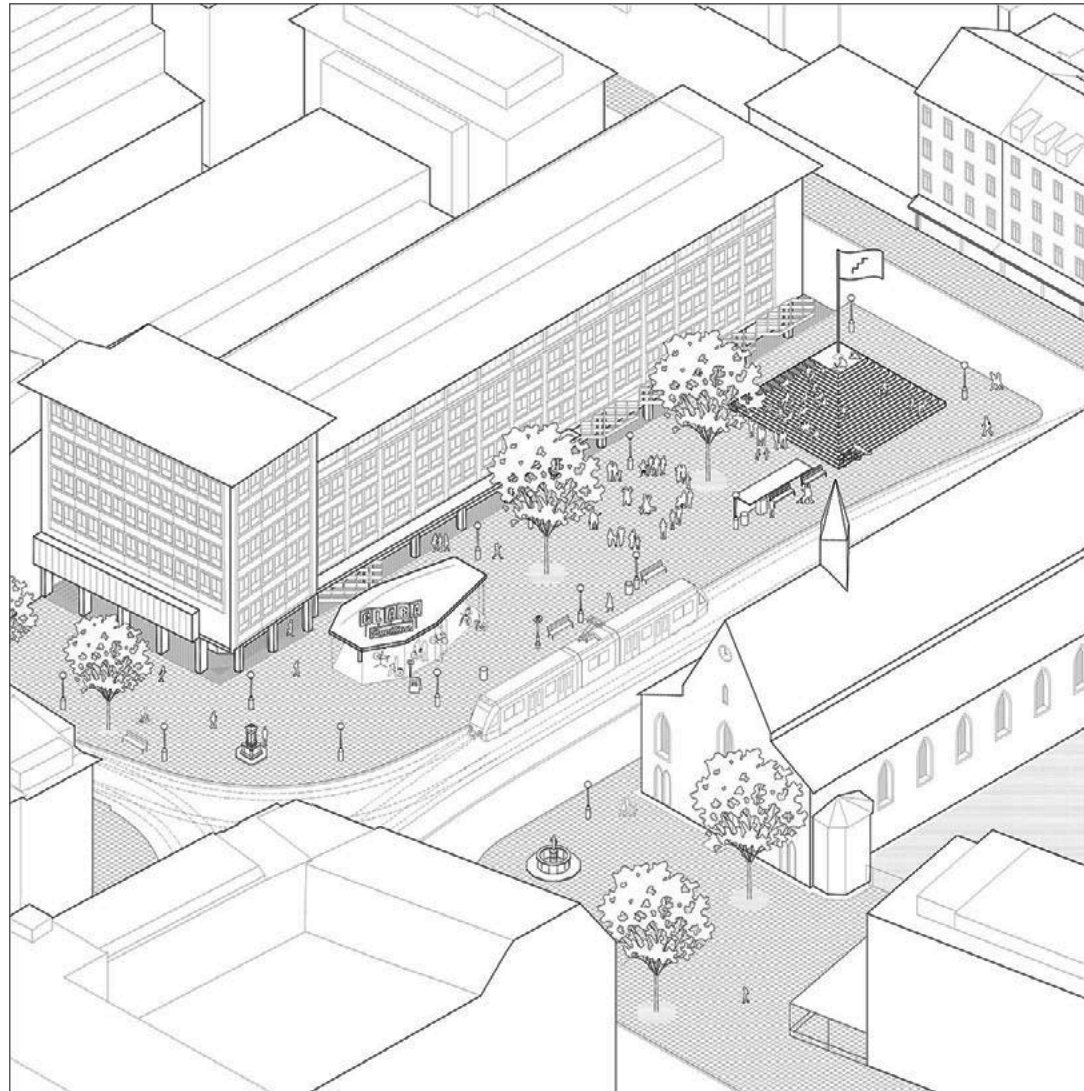

«Let's meet at the stairs» - Reuse and transformation of Claraplatz, Rahbaran Hürzeler Architekten



COMMON TALKS
SIX VIDEO INTERVIEWS

COMMON TALKS



Let's talk about Switzerland, Basel and Public Space.



COMMON PLACES
AN EXPERIMENT FOR PUBLIC SPACE

...

...

...

FORUM BASEL
THE MUSEUM AS PUBLIC SPACE

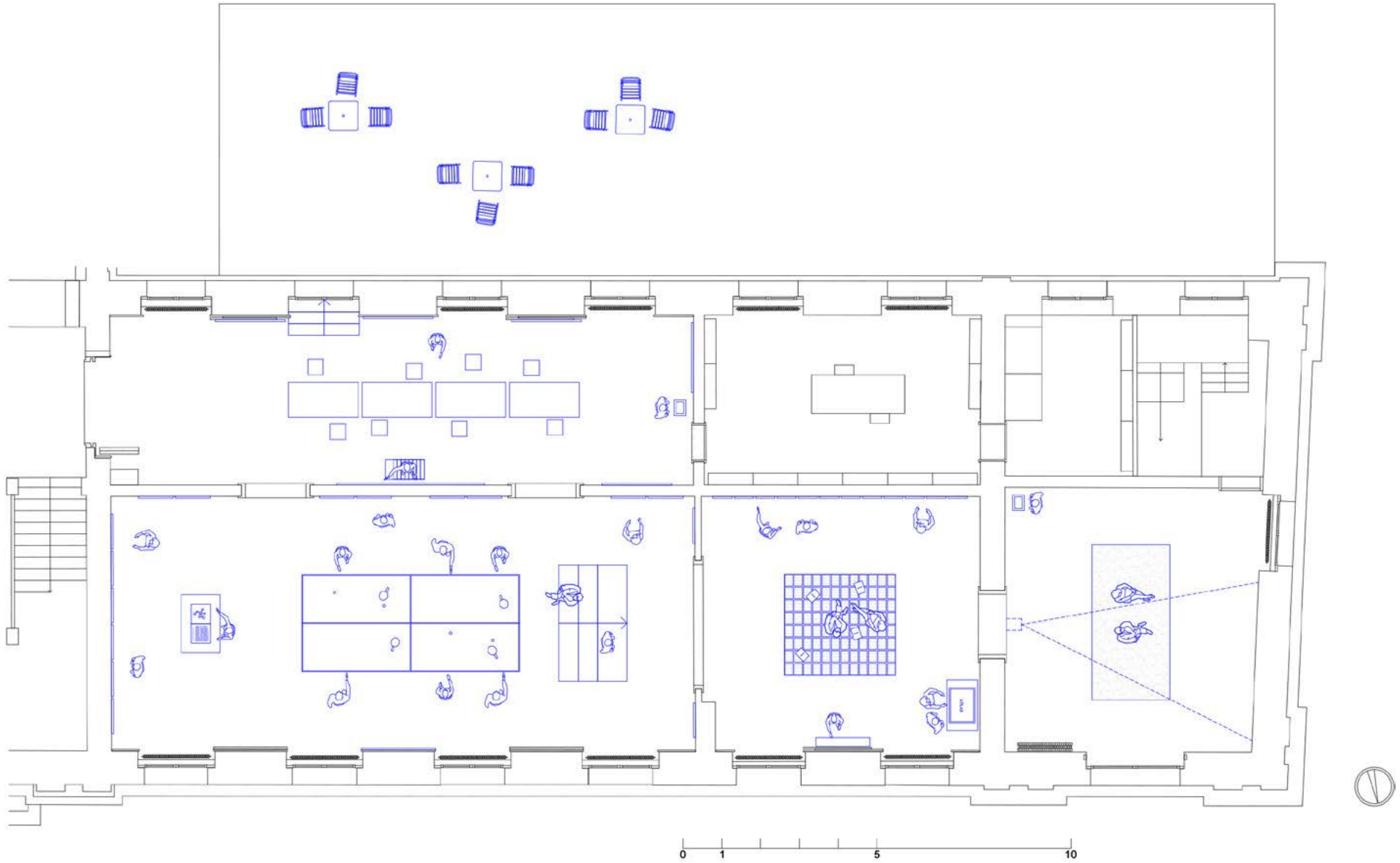

Exhibition layout plan



RIVER AS PUBLIC SPACE

**BORING
SECURE**

**DANGEROUS
EXCITING**

INDUSTRIAL PARKS FOR PEOPLE

DEREGULATED SPACES

FORUM BASEL MAP















RIVER AS PUBLIC SPACE

POSTING SCHEME

PHASES OF EXISTING

Architectural diagrams and site plans illustrating the concept of a river as public space, showing various phases and existing conditions.

INDUSTRIAL PARKS FOR PEOPLE

RESTRICTED CONTROLLED

CHAOTIC FREE-SPIRITED

Architectural diagrams and site plans illustrating industrial parks for people, divided into 'RESTRICTED CONTROLLED' and 'CHAOTIC FREE-SPIRITED' categories.





FOR PEOPLE

CHAOTIC
FREE-SPIRITED

PUBLIC RITUALS

DEREGULATED SPACES

PROHIBITING
PROTECTED

ILLEGAL
INNOVATIVE

TOWN OF PUBLIC SPACES



