

MEB
VII-53

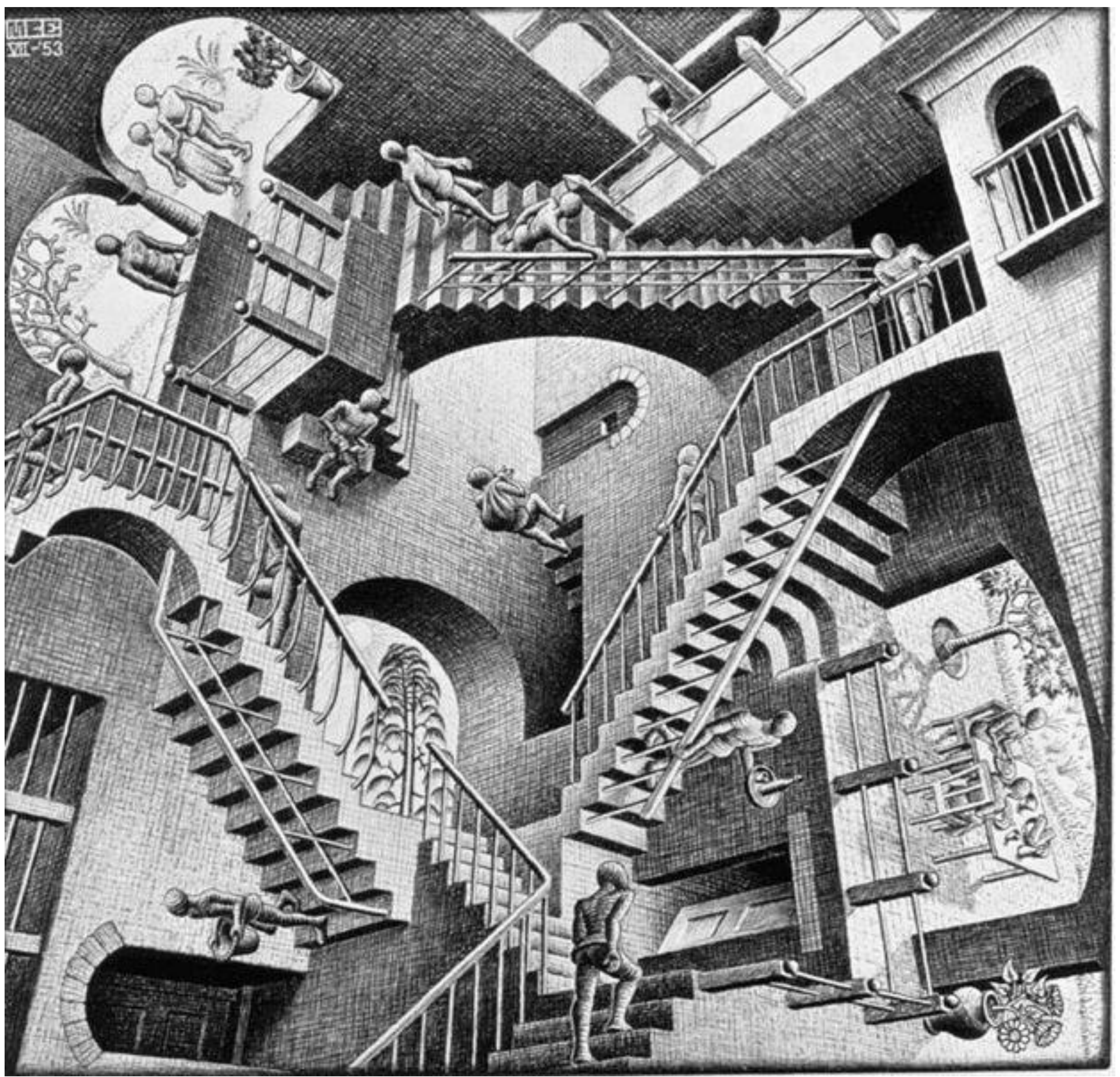









LE LABYRINTE DE VERSAILLES

Le Labyrinthe de Versailles a été construit en 1699 par le Roi Louis XIV. Il est composé de cent cinquante chemins qui se croisent en cent cinquante points. On peut y aller par cent cinquante chemins différents. On peut y aller par cent cinquante chemins différents. On peut y aller par cent cinquante chemins différents.

CETTE PROX

qui est un plan de la ville de Versailles, est divisée en cent cinquante chemins qui se croisent en cent cinquante points. On peut y aller par cent cinquante chemins différents. On peut y aller par cent cinquante chemins différents. On peut y aller par cent cinquante chemins différents.

A. Entrée des jardins par le pont de l'Orangerie.
B. Fontaine de Bassin ou de l'Apollon.

1. Le Parc & Le Jardin
2. Le Parc & Le Jardin
3. Le Parc & Le Jardin
4. Le Parc & Le Jardin
5. Le Parc & Le Jardin
6. Le Parc & Le Jardin
7. Le Parc & Le Jardin
8. Le Parc & Le Jardin
9. Le Parc & Le Jardin
10. Le Parc & Le Jardin
11. Le Parc & Le Jardin
12. Le Parc & Le Jardin
13. Le Parc & Le Jardin
14. Le Parc & Le Jardin
15. Le Parc & Le Jardin
16. Le Parc & Le Jardin
17. Le Parc & Le Jardin
18. Le Parc & Le Jardin
19. Le Parc & Le Jardin
20. Le Parc & Le Jardin
21. Le Parc & Le Jardin
22. Le Parc & Le Jardin
23. Le Parc & Le Jardin
24. Le Parc & Le Jardin
25. Le Parc & Le Jardin
26. Le Parc & Le Jardin
27. Le Parc & Le Jardin
28. Le Parc & Le Jardin
29. Le Parc & Le Jardin
30. Le Parc & Le Jardin
31. Le Parc & Le Jardin
32. Le Parc & Le Jardin
33. Le Parc & Le Jardin
34. Le Parc & Le Jardin
35. Le Parc & Le Jardin
36. Le Parc & Le Jardin
37. Le Parc & Le Jardin
38. Le Parc & Le Jardin
39. Le Parc & Le Jardin
40. Le Parc & Le Jardin
41. Le Parc & Le Jardin
42. Le Parc & Le Jardin
43. Le Parc & Le Jardin
44. Le Parc & Le Jardin
45. Le Parc & Le Jardin
46. Le Parc & Le Jardin
47. Le Parc & Le Jardin
48. Le Parc & Le Jardin
49. Le Parc & Le Jardin
50. Le Parc & Le Jardin
51. Le Parc & Le Jardin
52. Le Parc & Le Jardin
53. Le Parc & Le Jardin
54. Le Parc & Le Jardin
55. Le Parc & Le Jardin
56. Le Parc & Le Jardin
57. Le Parc & Le Jardin
58. Le Parc & Le Jardin
59. Le Parc & Le Jardin
60. Le Parc & Le Jardin
61. Le Parc & Le Jardin
62. Le Parc & Le Jardin
63. Le Parc & Le Jardin
64. Le Parc & Le Jardin
65. Le Parc & Le Jardin
66. Le Parc & Le Jardin
67. Le Parc & Le Jardin
68. Le Parc & Le Jardin
69. Le Parc & Le Jardin
70. Le Parc & Le Jardin
71. Le Parc & Le Jardin
72. Le Parc & Le Jardin
73. Le Parc & Le Jardin
74. Le Parc & Le Jardin
75. Le Parc & Le Jardin
76. Le Parc & Le Jardin
77. Le Parc & Le Jardin
78. Le Parc & Le Jardin
79. Le Parc & Le Jardin
80. Le Parc & Le Jardin
81. Le Parc & Le Jardin
82. Le Parc & Le Jardin
83. Le Parc & Le Jardin
84. Le Parc & Le Jardin
85. Le Parc & Le Jardin
86. Le Parc & Le Jardin
87. Le Parc & Le Jardin
88. Le Parc & Le Jardin
89. Le Parc & Le Jardin
90. Le Parc & Le Jardin
91. Le Parc & Le Jardin
92. Le Parc & Le Jardin
93. Le Parc & Le Jardin
94. Le Parc & Le Jardin
95. Le Parc & Le Jardin
96. Le Parc & Le Jardin
97. Le Parc & Le Jardin
98. Le Parc & Le Jardin
99. Le Parc & Le Jardin
100. Le Parc & Le Jardin

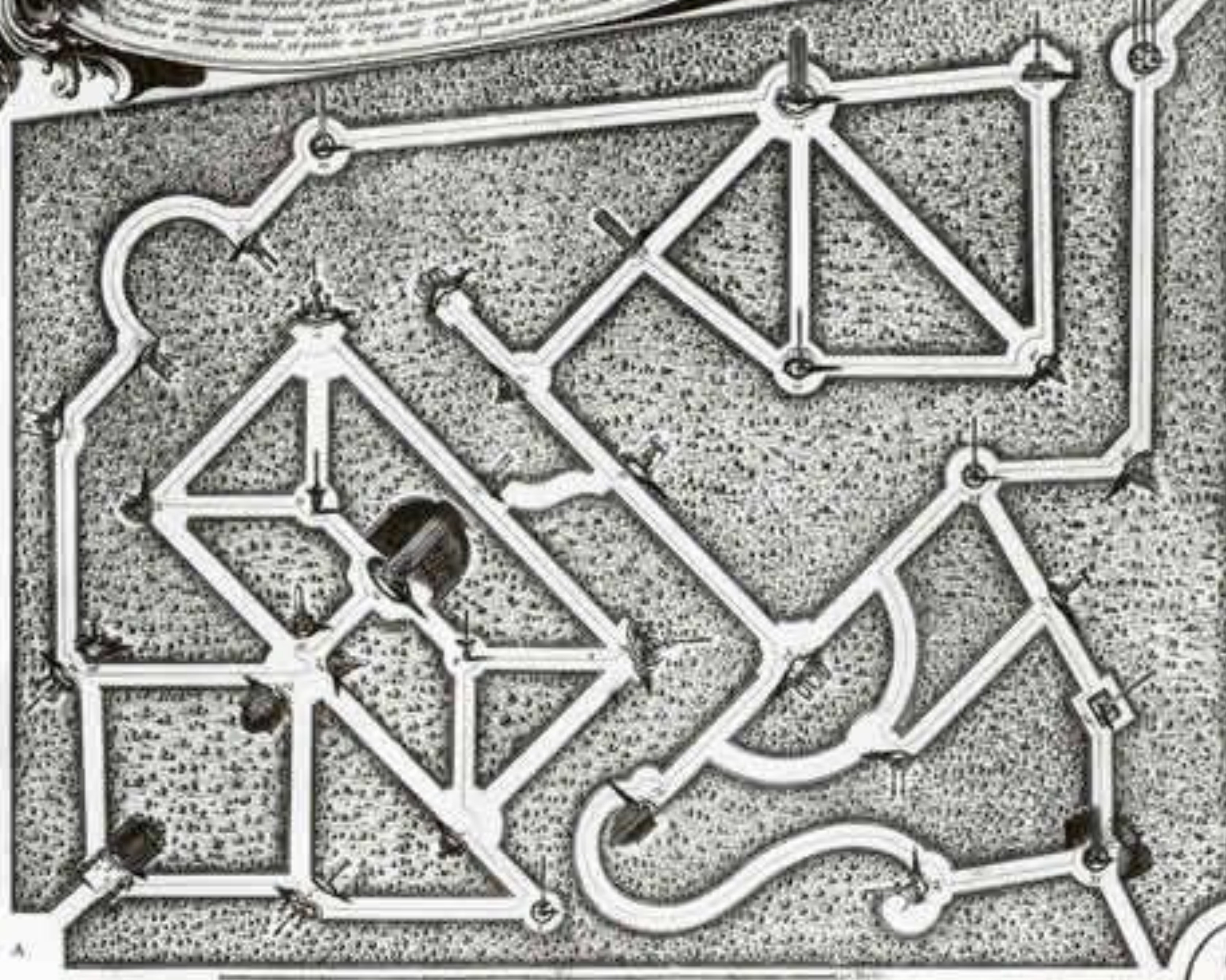

A

B

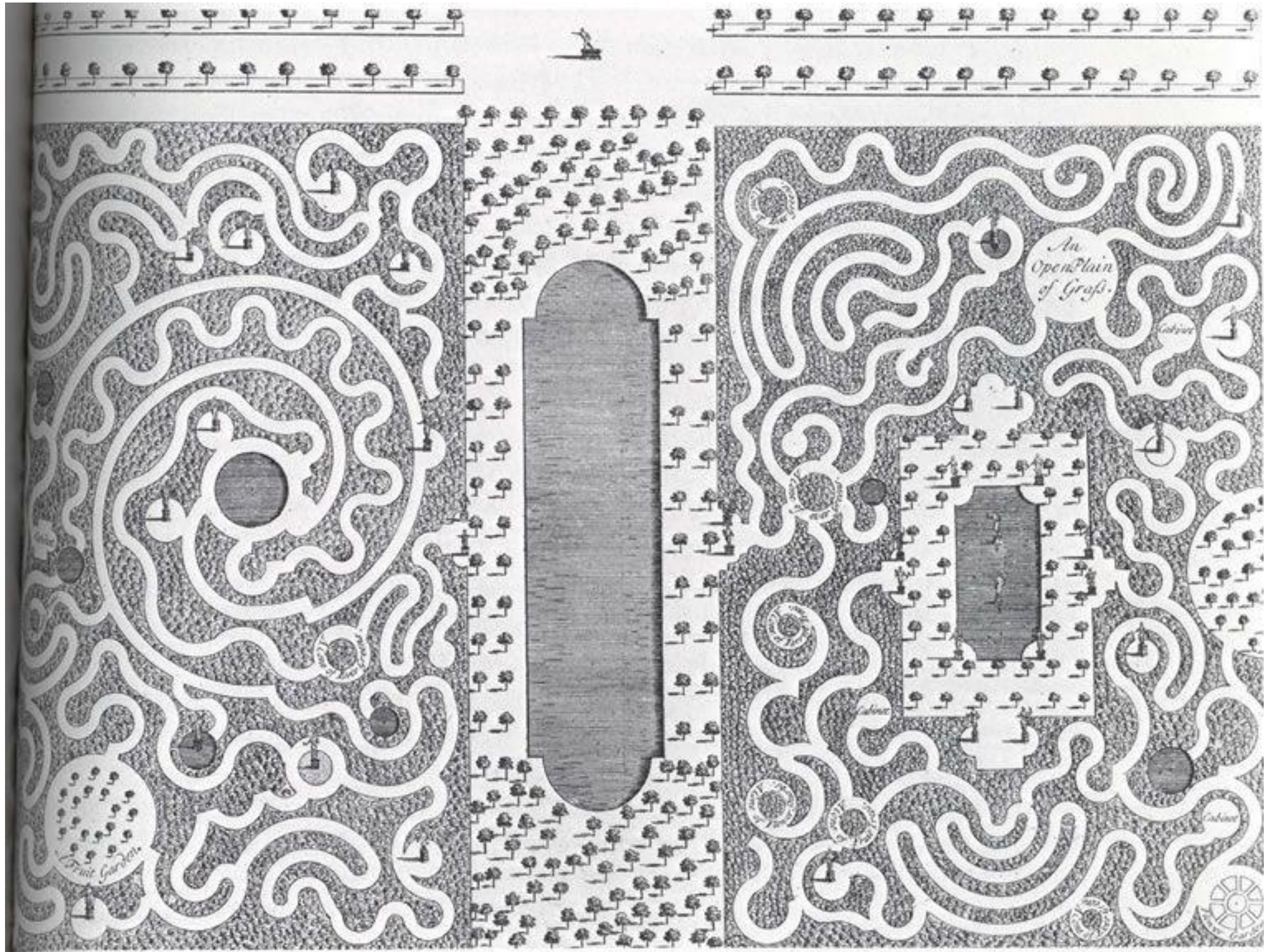

*An
Open Plain
of Grass.*

Fruit Garden





































































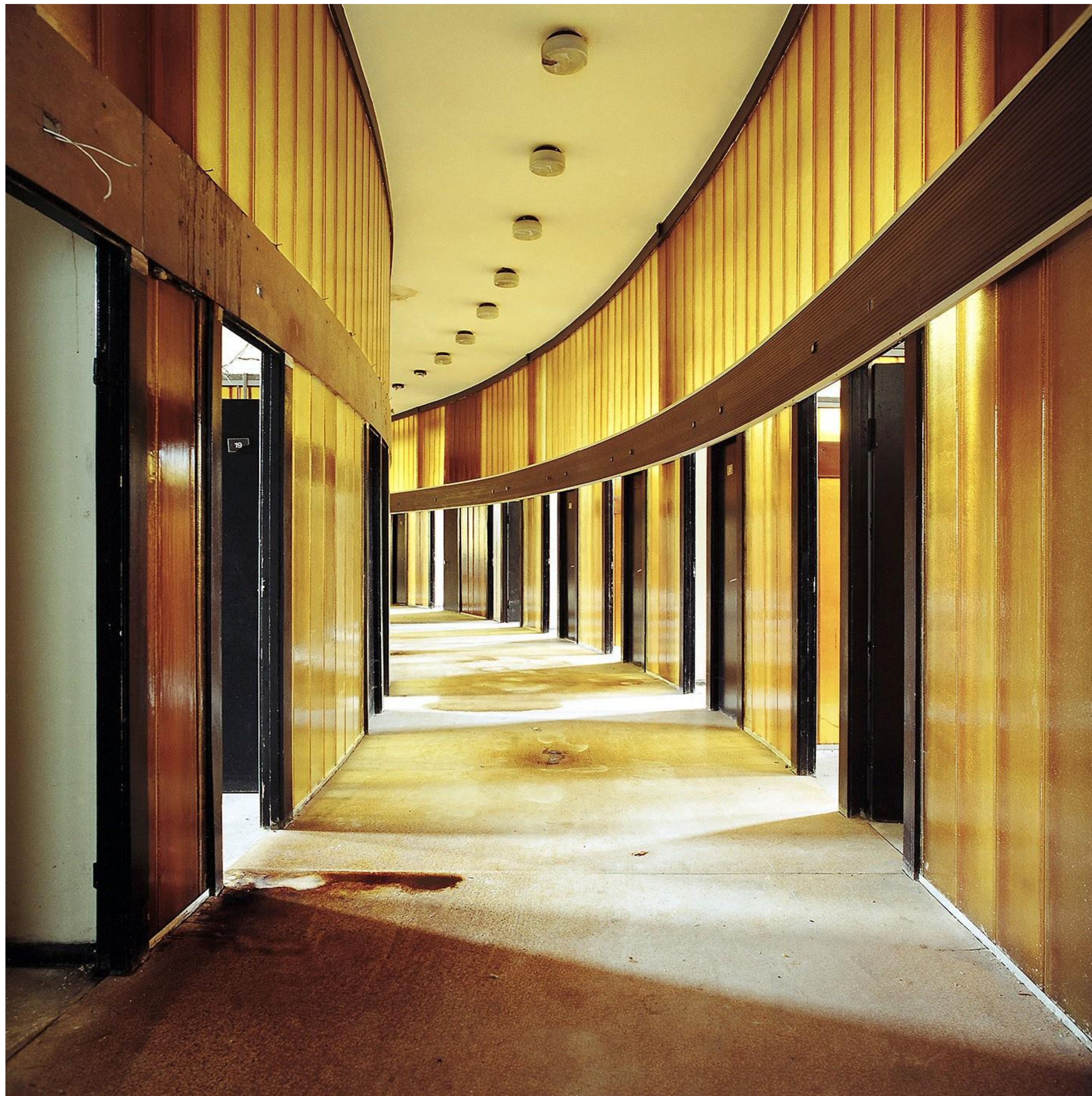













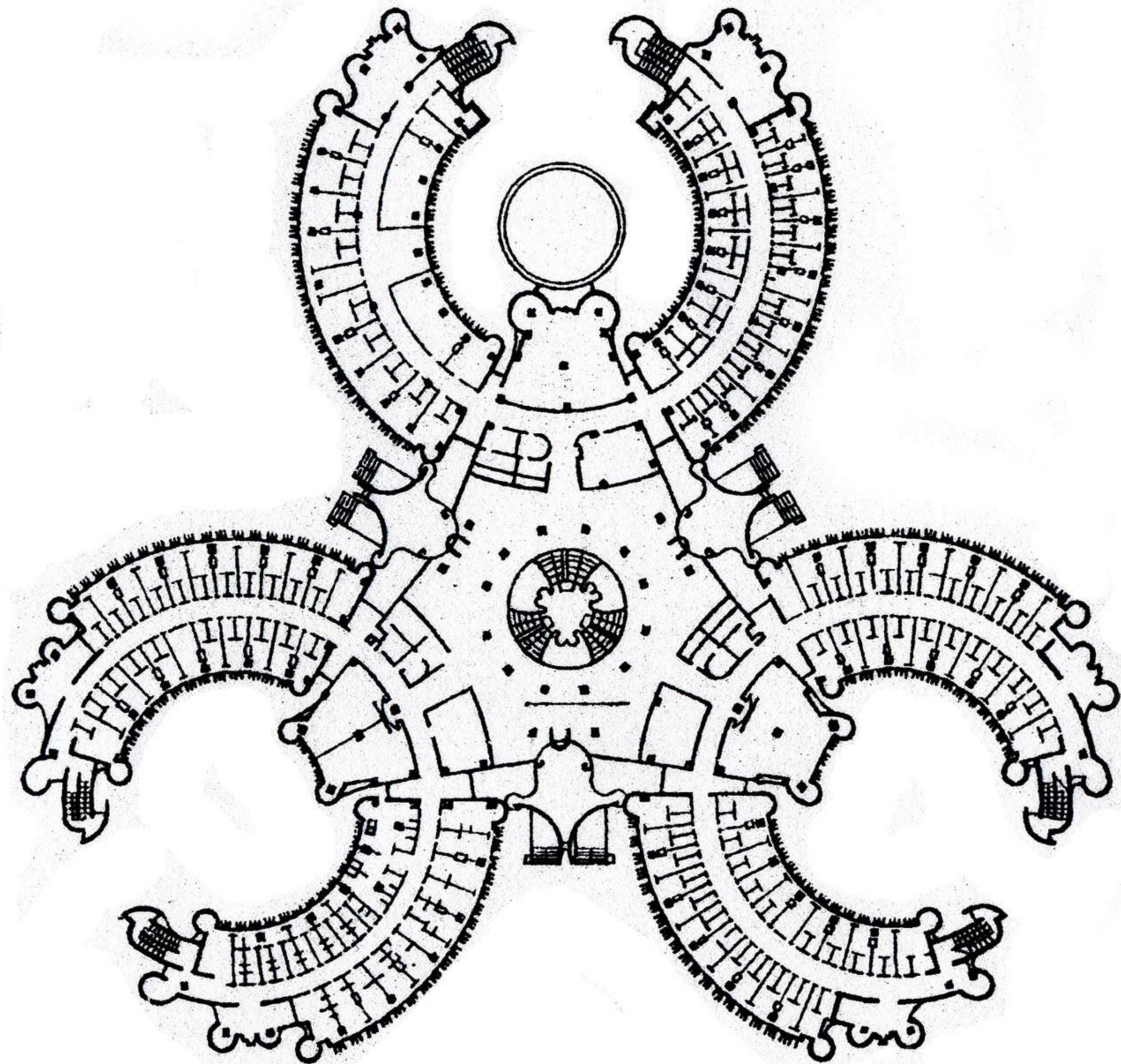
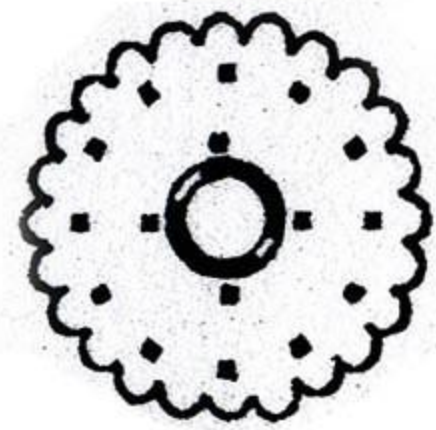































































Bride
Bride
Bride

MOST GARMENTS
\$2.29
LEATHER & SUEDE FURS

AUNDRY WEDDING GOWN

NO PARKING
EXCEPT FOR DELIVERIES
AND PICKUPS ONLY
BY APPOINTMENT

PAY FOR PARKING
AT PAY BOX







WARSZAWA POWIŚLE

PRASA
PAPIEROSY
NAPOJE
SŁODYCZE
DOBRE CENY...



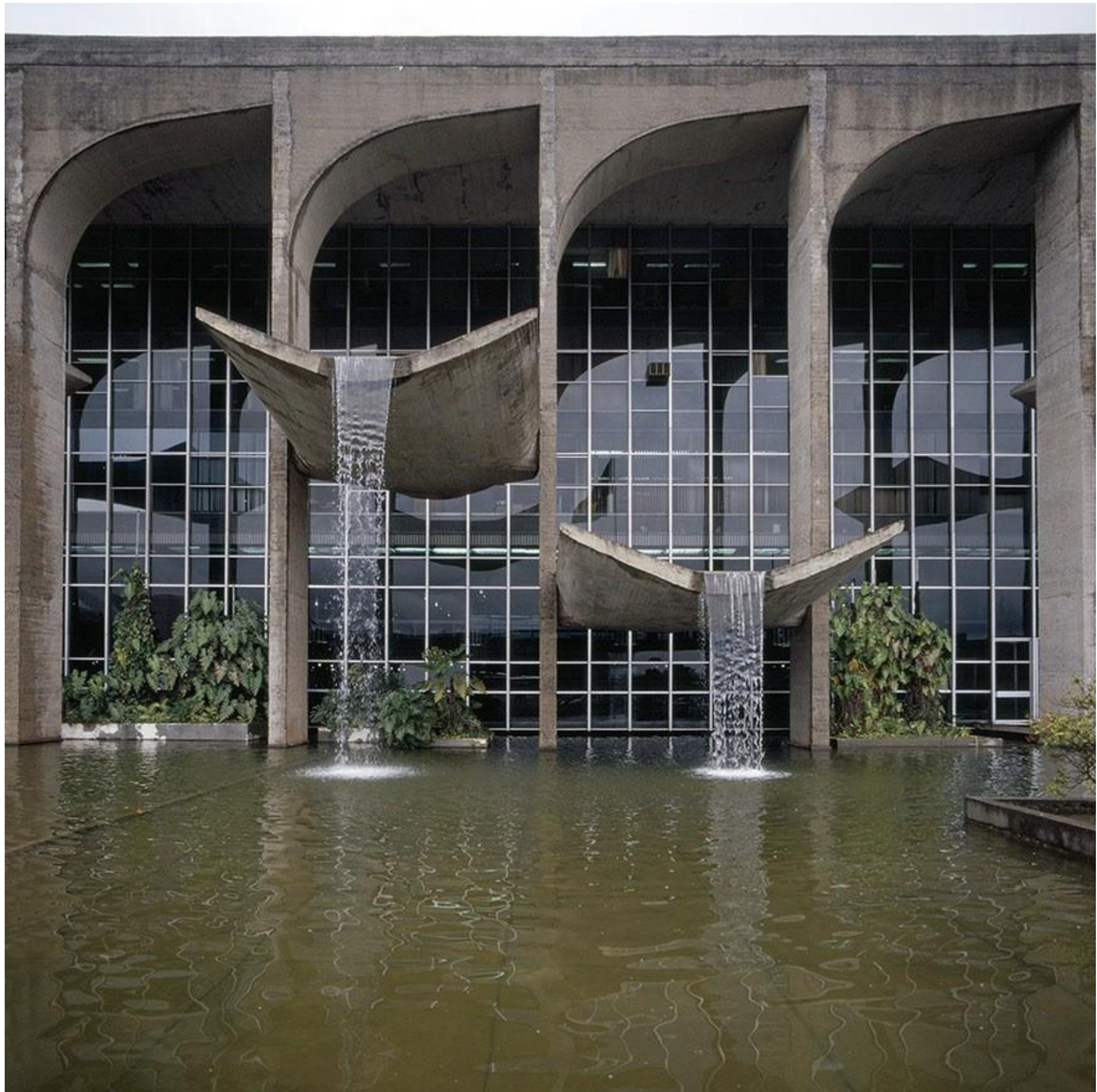









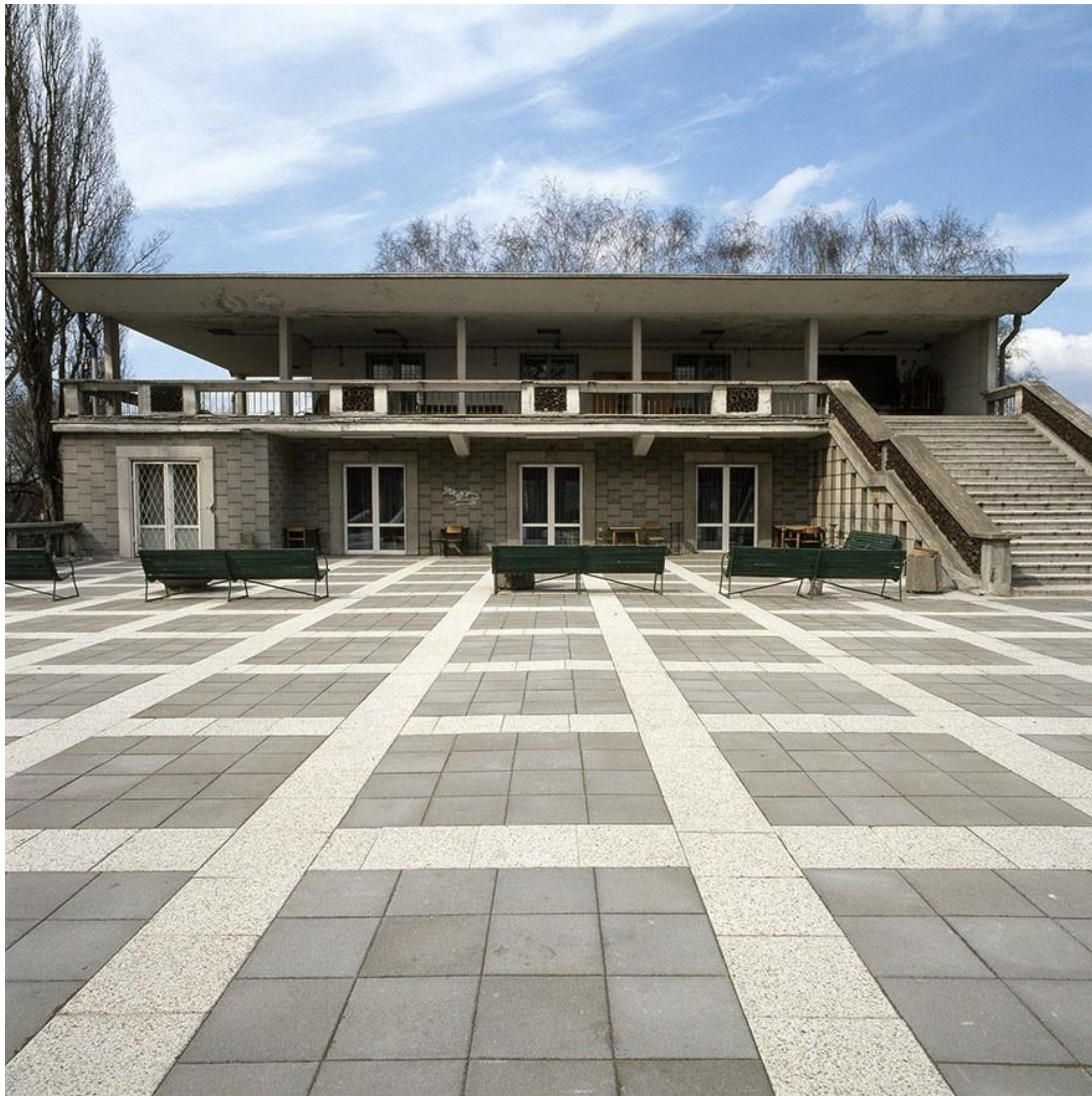

























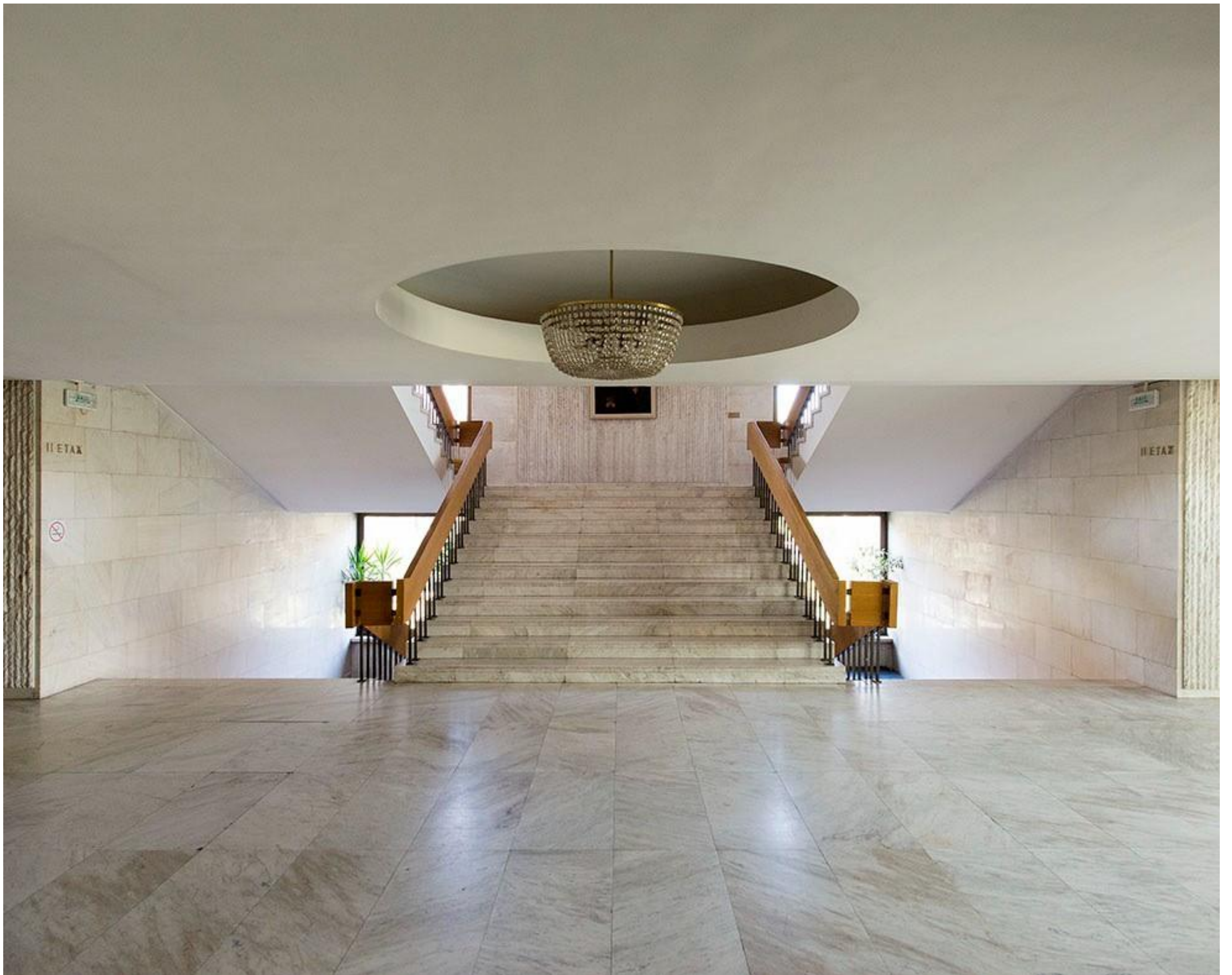











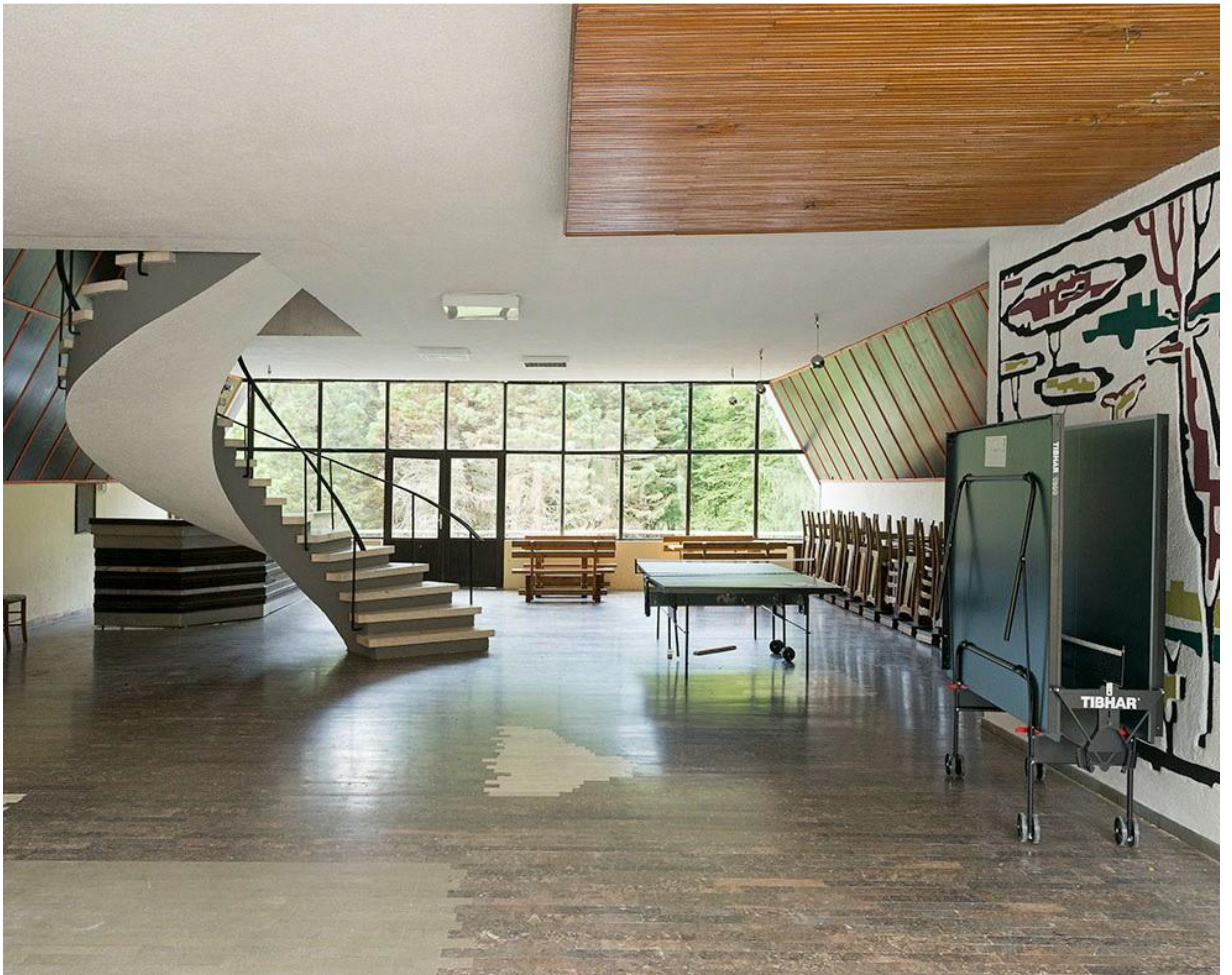

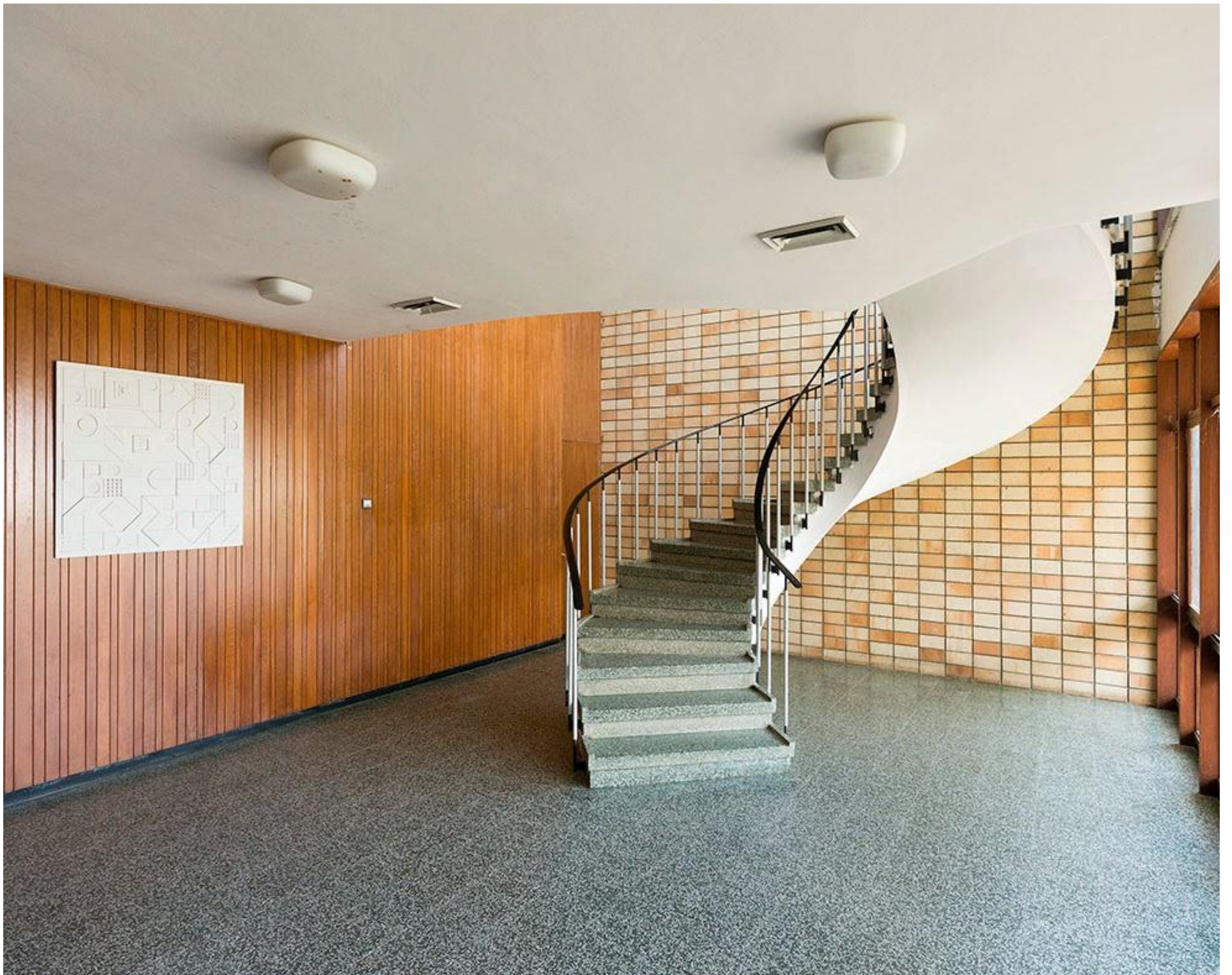



Oval Offices locations Lokalizacje Owalnych Gabinetów

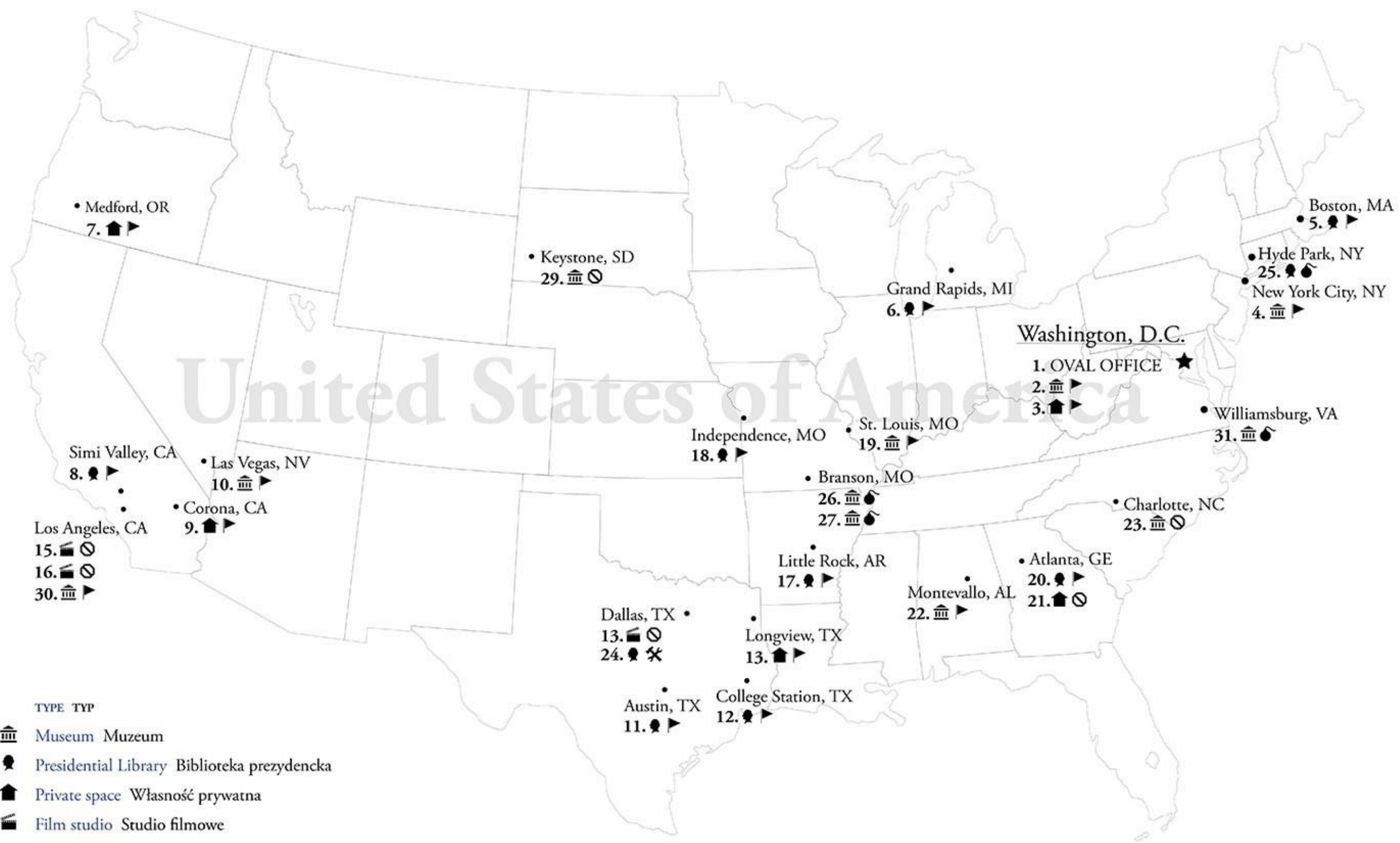

- TYPE TYP
- Museum Muzeum
 - Presidential Library Biblioteka prezydencka
 - Private space Własność prywatna
 - Film studio Studio filmowe
- STATUS STATUS
- Visited Odwiedzony
 - Inaccessible Niedostępny
 - Destroyed Zburzony
 - In construction W budowie

1. Oval Office
2. Madame Tussaud's Washington DC
3. White House Gifts
4. Madame Tussaud's NYC
5. John F. Kennedy Presidential Library
6. GERALD R. FORD Presidential Library
7. Rogue Valley International Medford Airport
8. Ronald Reagan Presidential Library
9. Quality West Wing Foundation
10. Madame Tussaud's Las Vegas
11. Lyndon B. Johnson Presidential Library
12. George W.H. Bush Presidential Library
13. Ron Wade Home
14. Glenn Beck TV Studio
15. ABC studios
16. 20th Century Fox Studios
17. William Clinton Presidential Library
18. Harry Truman Presidential Library
19. The Magic House
20. Jimmy Carter Presidential Library
21. Atlanta White House
22. The American Village
23. The American Presidential Experience
24. George W. Bush Presidential Library
25. Franklin D. Roosevelt Presidential Library
26. American Presidential Museum
27. America's Presidency
28. Florida International Museum
29. National Presidential Wax Museum
30. Madame Tussaud's Hollywood
31. Presidents Park



























NAME the PRESIDENT
The White House is the home of presidents and their families during their time in office.
Which president would you like to call home?

















Attraction
Continues

EXIT

Spirit of
New York



EXIT

Change will not
come for some other
time. We've been waiting
for change.

Barack
Michelle

The growth of Oval Office replicas since 1957 Wzrost ilości replik Owального Gabinetu od 1957 r.

Amount of Oval Office replicas
Ilość Owalnych Gabinetów

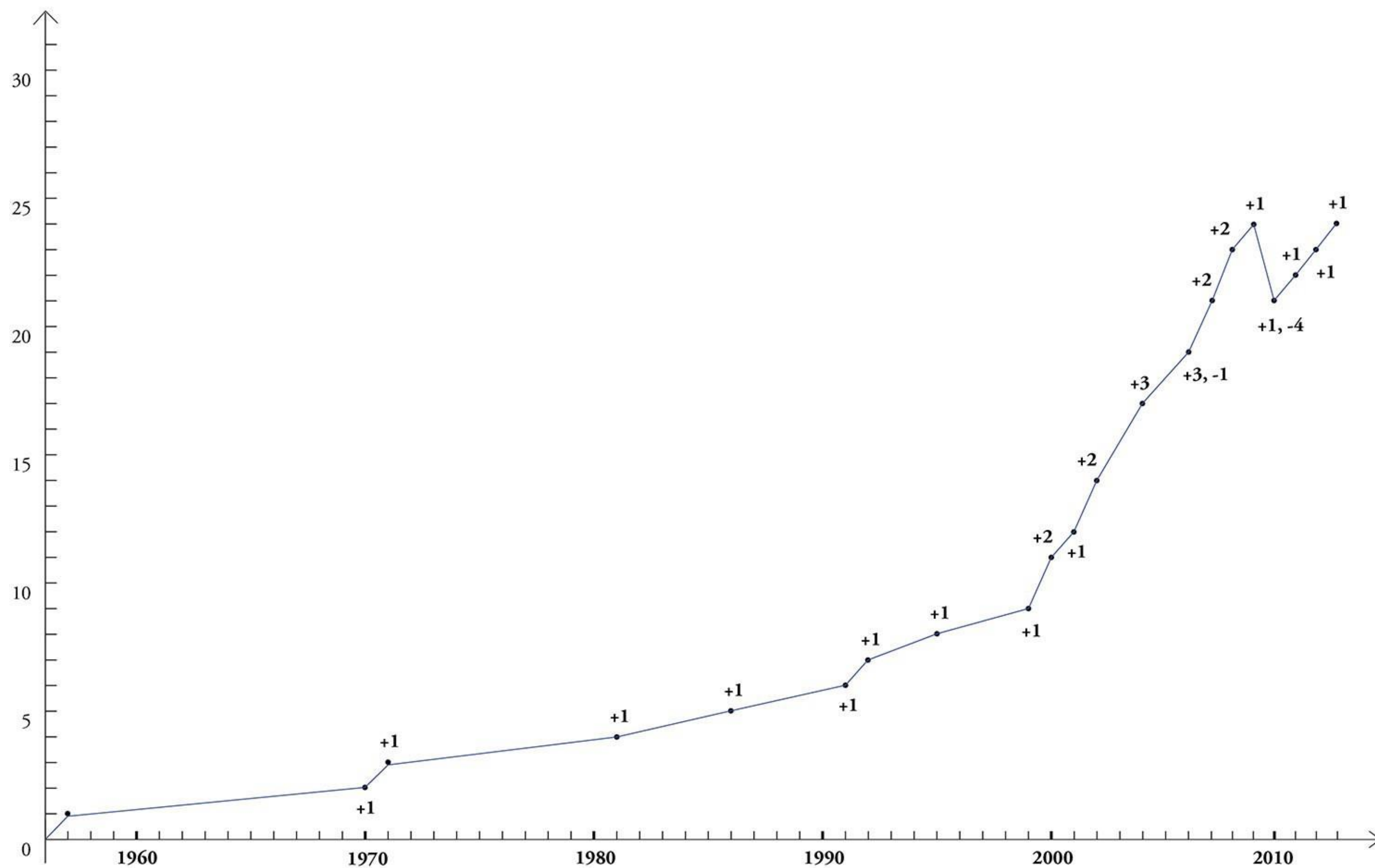

Kamień Omphalos w muzeum archeologiczne w Delfi



Omphalion w Bazylice Hagia Sophia w Sztambule



Pierre Omphalos en l'église du Saint-Sépulcre, Jérusalem



Umbilicus urbis Romae



Chiesa di Sant'Andrea al Quirinale, Roma, (1661)



The oval lawn in English garden design
Owalny trawnik w angielskim projektowaniu ogrodów

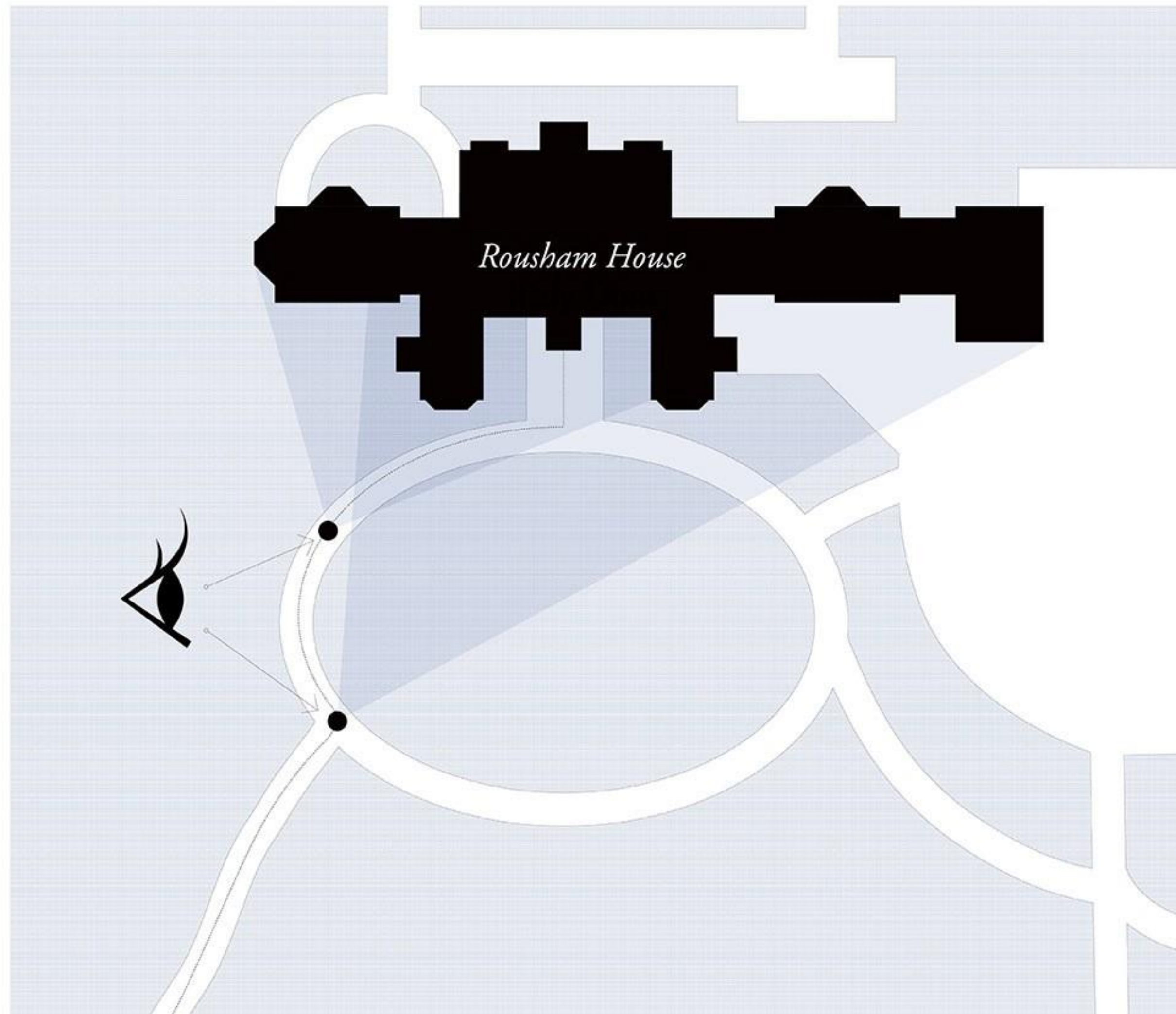

The oval lawn in front of Rousham House (1741) provides a smooth arrival to the palace: the perspective on the façade evolves as the visitor approaches.

Owalny trawnik na przeciwko Rousham House (1741) tworzy łagodny dojazd do palacu, perspektywa na elewację budynku zmienia się w miarę zbliżania się.

The Hollywood connection





The growth of films featuring the Oval Office since 1940

Wzrost ilości filmów pokazujących Owalny Gabinet od 1940 r.

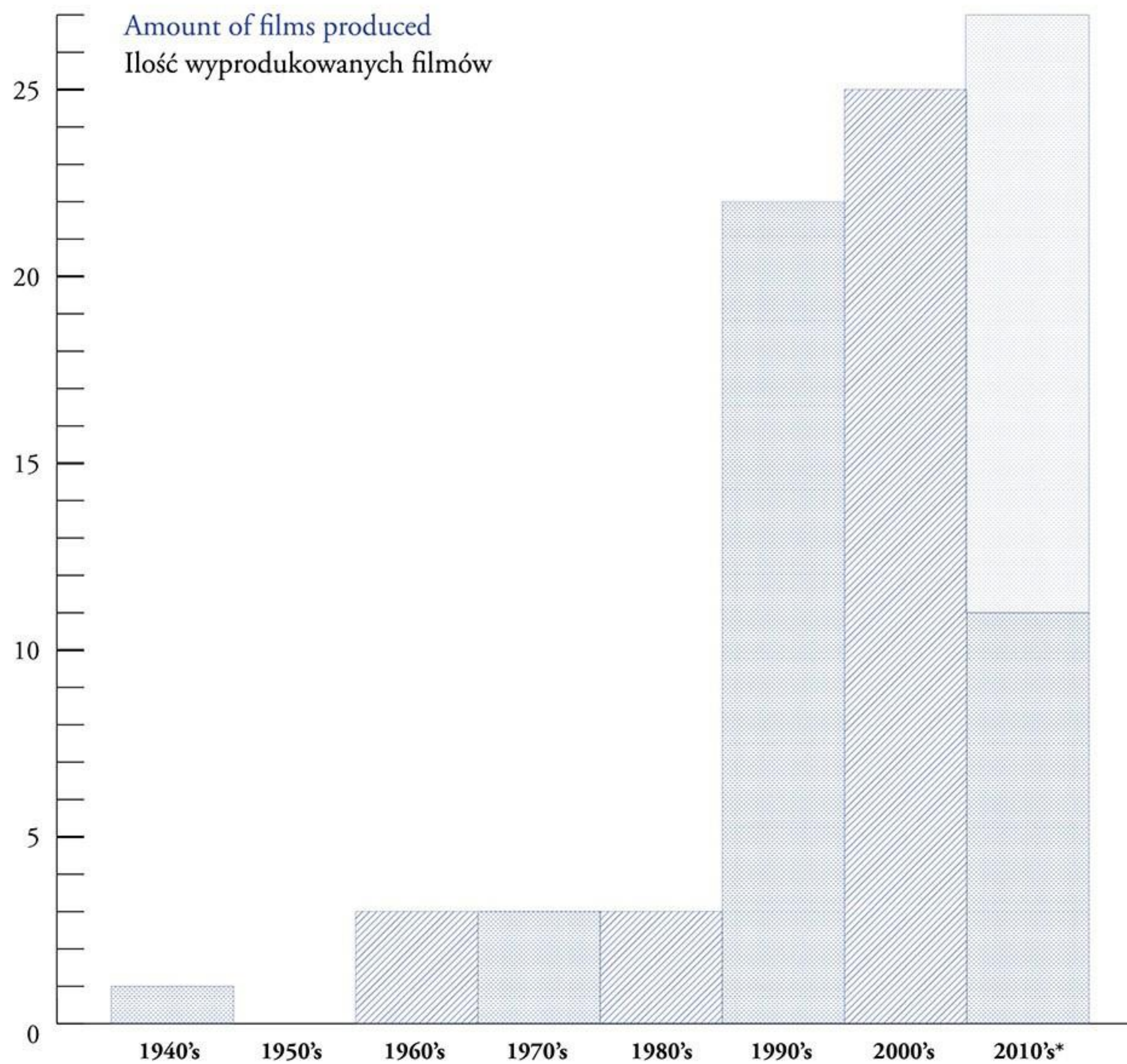

** The lightly shaded area corresponds to the projected amount of films produced during the remaining of the 2010's.*

** Rozjaśniony szary obszar wyznacza przewidywana ilość filmów wyprodukowanych w pozostałych latach obecnej dekady.*









2

RENTGEN
ODDZIAŁ FIZJOTERAPII
TEL. 845 - 96 - 30
LUTY 1998 R. 14. 17. 18. 19.

REKOL-MED
ODDZIAŁ FIZJOTERAPII I LECZENIA
REHABILITACJA I LECZENIE

REHABILITACJA











DO SPRZEDANIA

www.emmerson.pl

EMMERSON
NIERUCHOMOŚCI REAL ESTATE

649-36-62









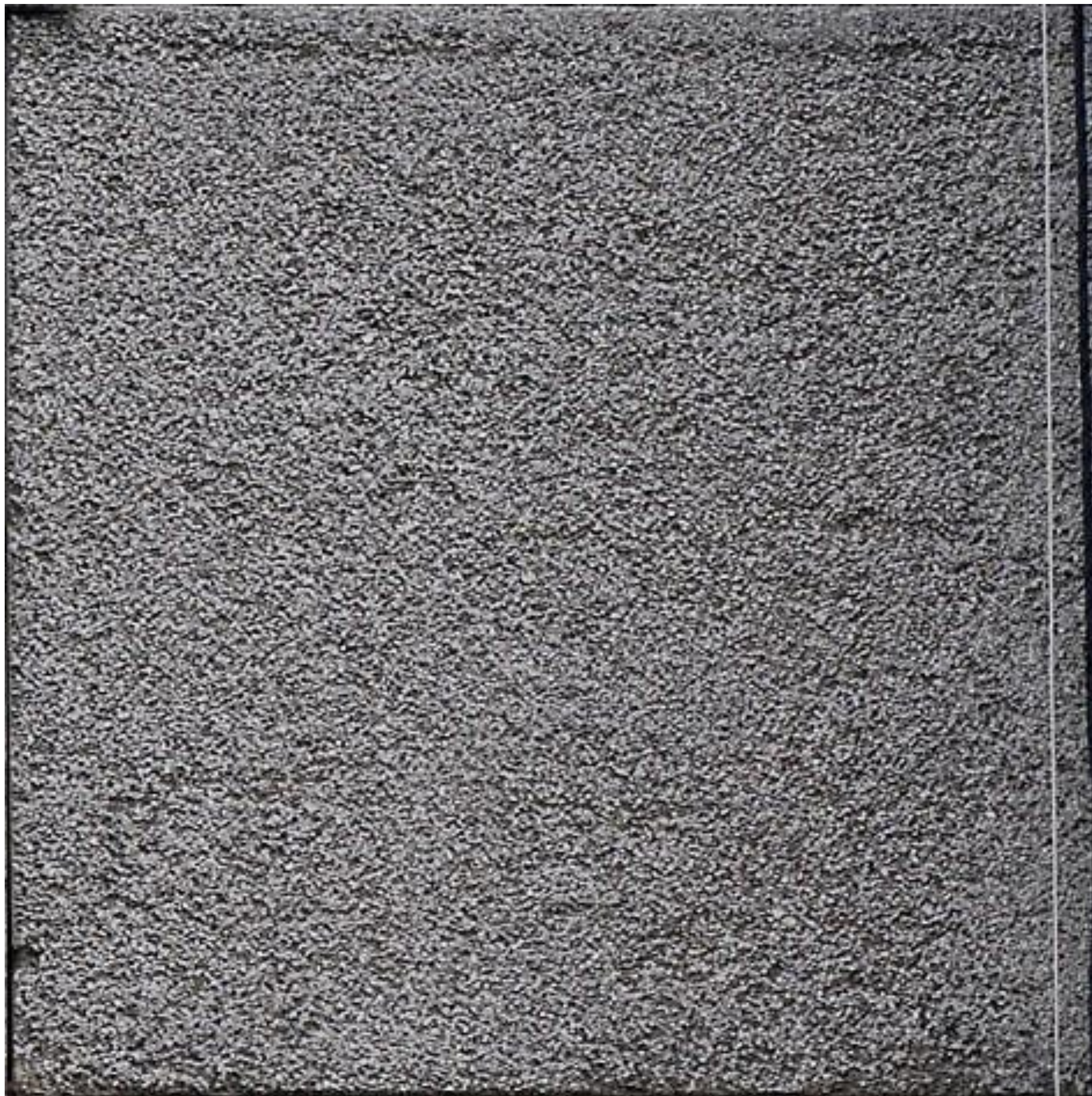





















Small rectangular plaque or sign on the white wall to the left of the building.































0 10 20 30m

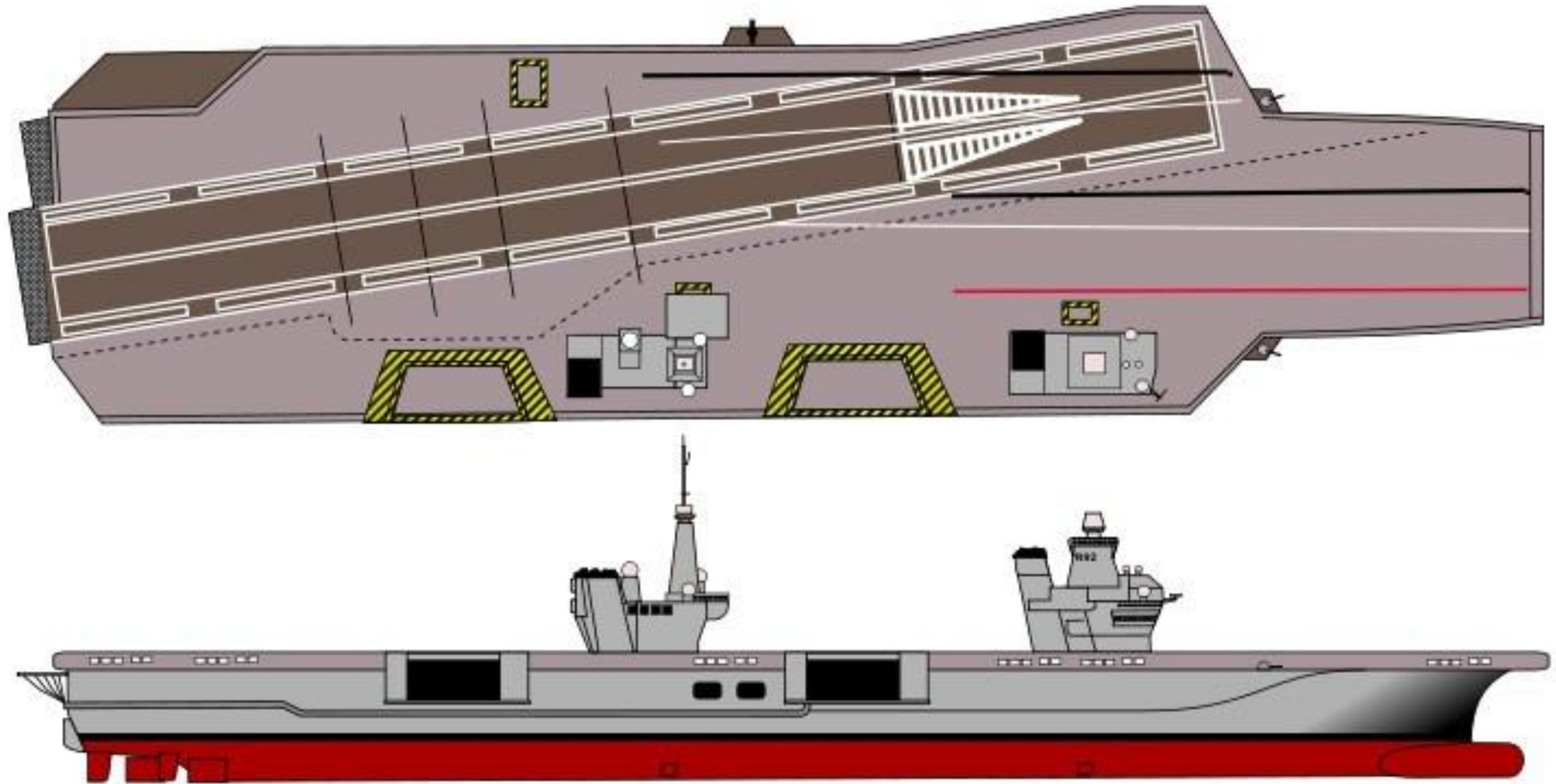

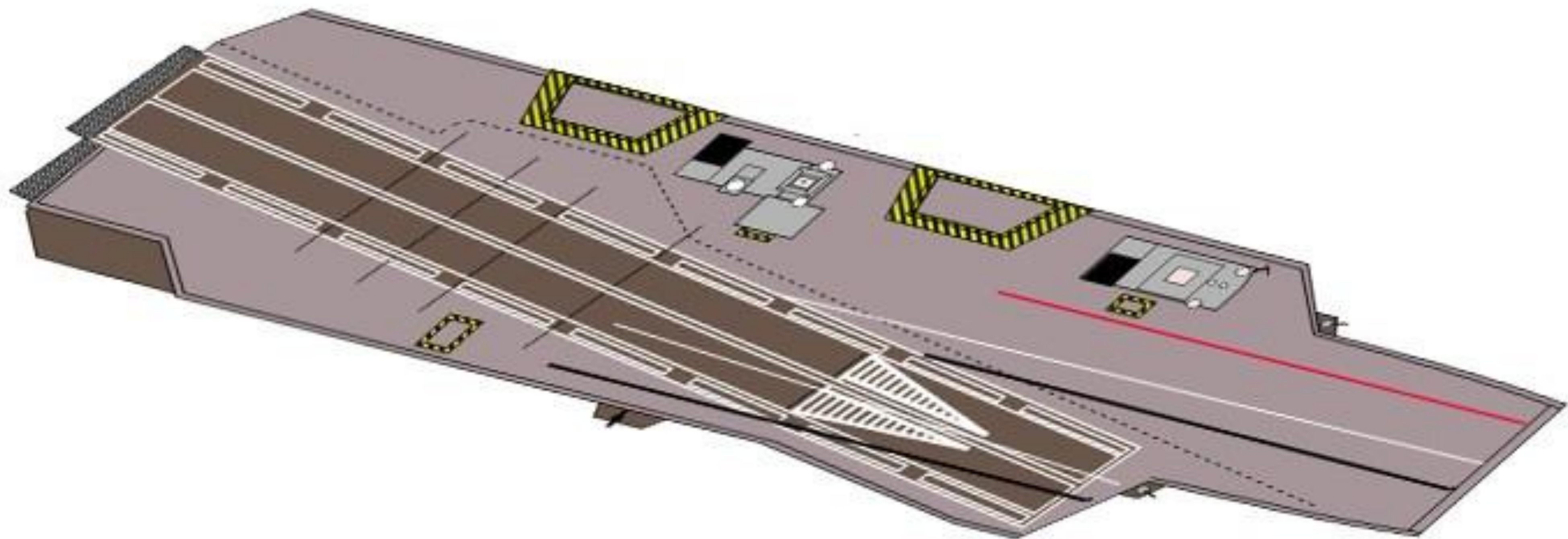

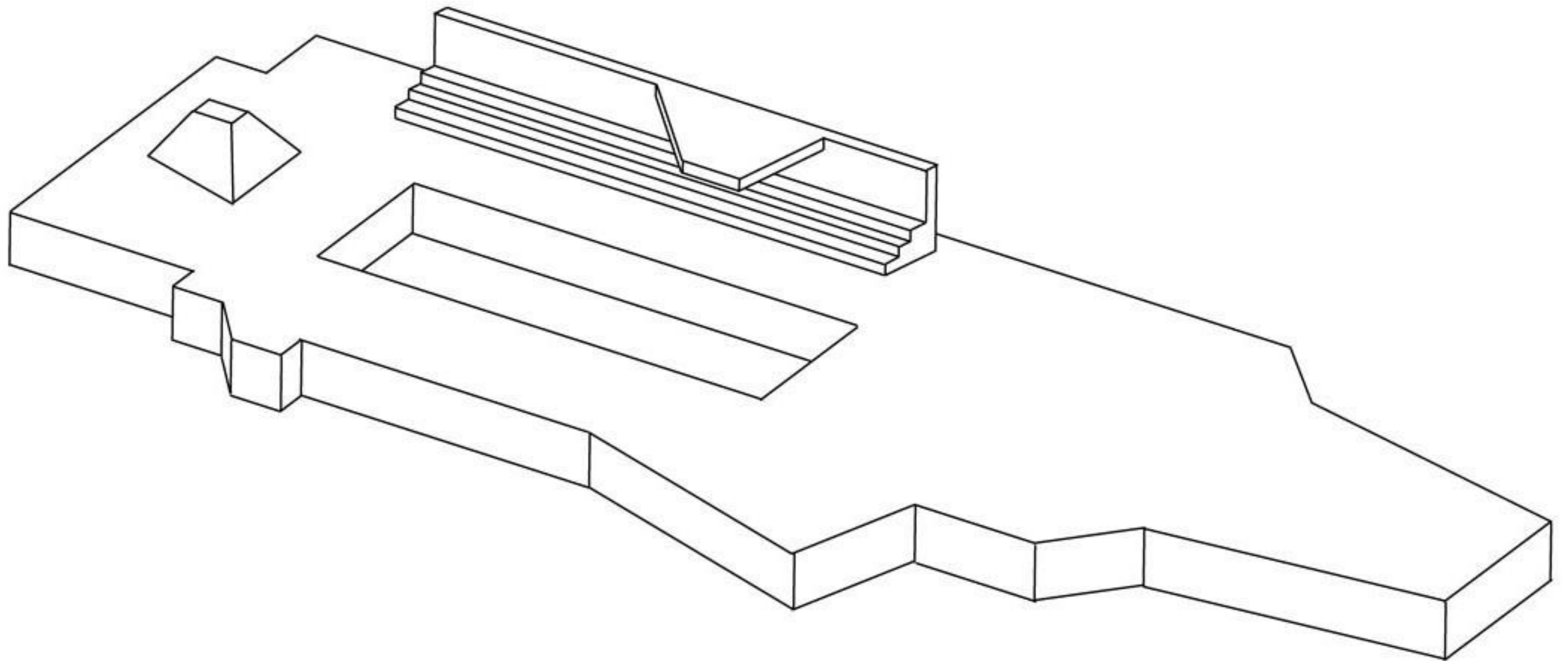































































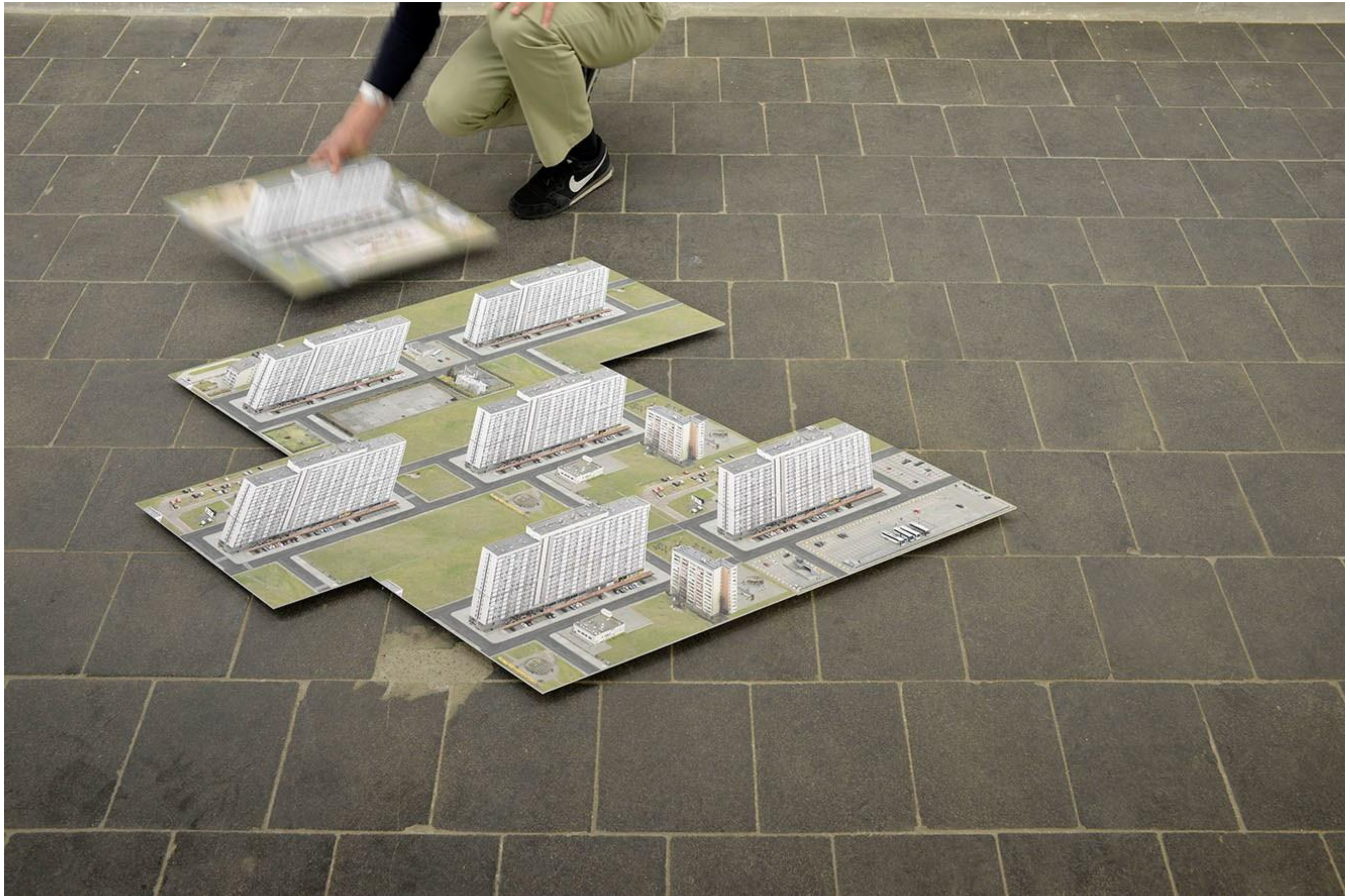

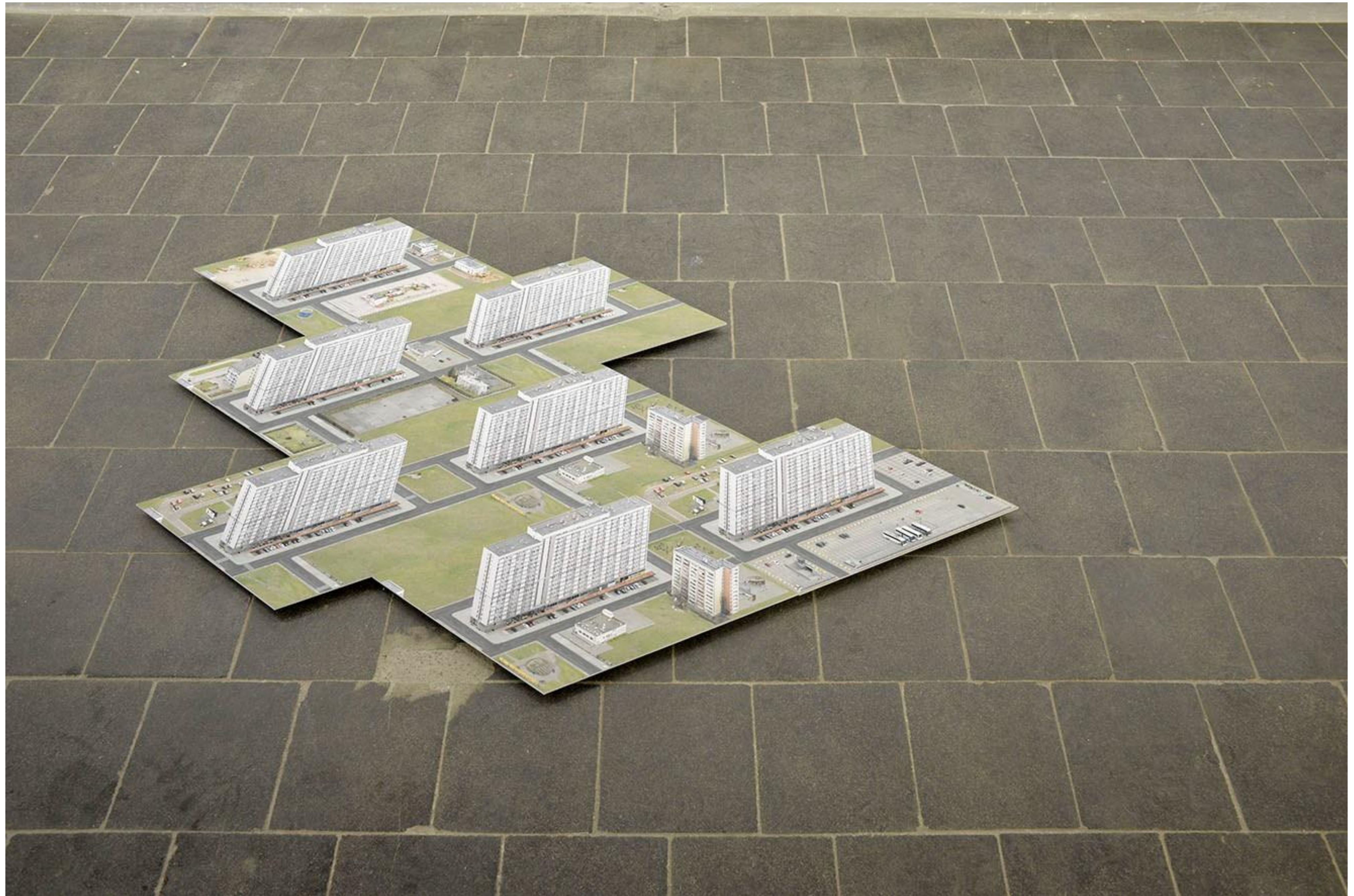











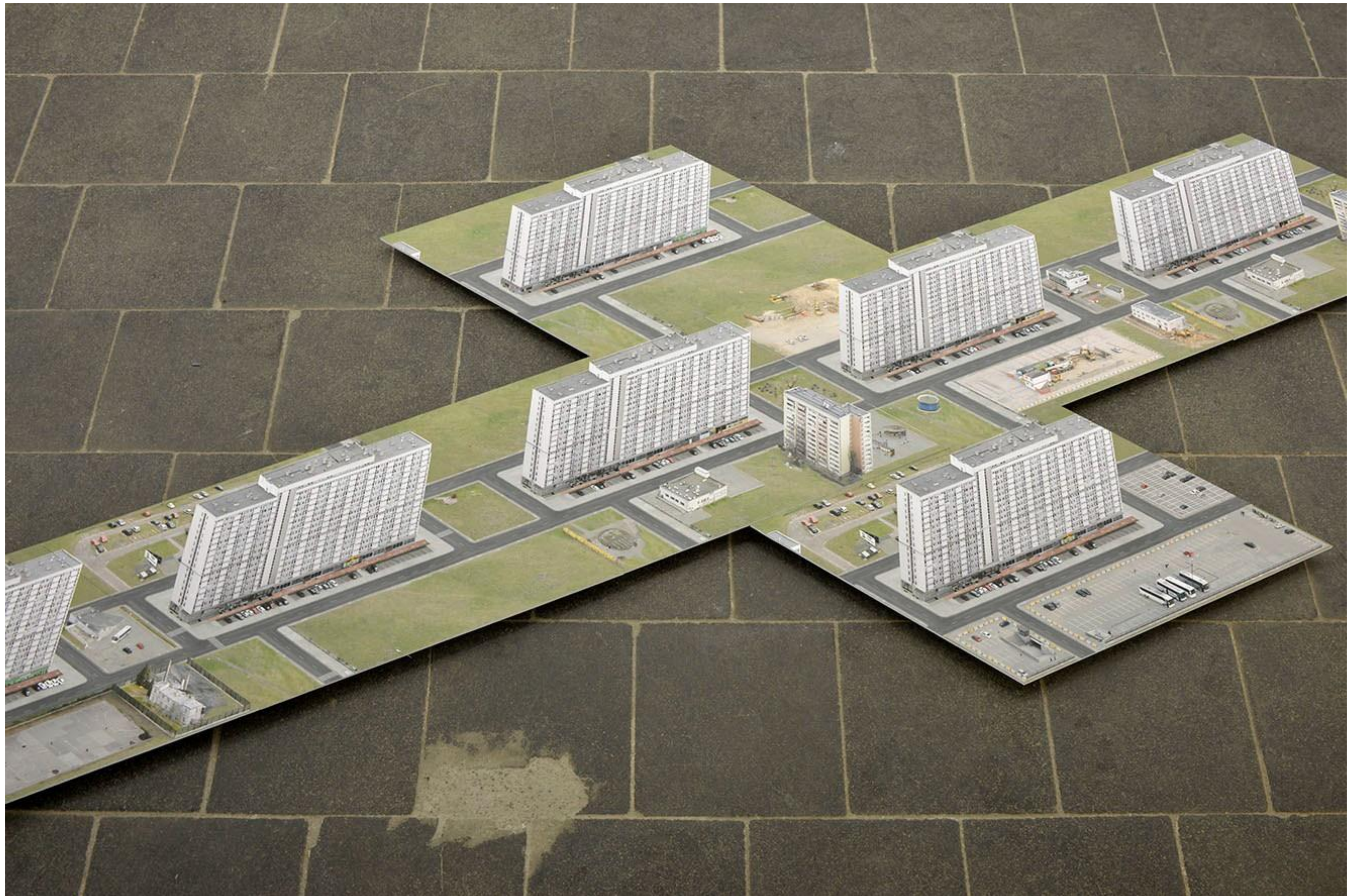

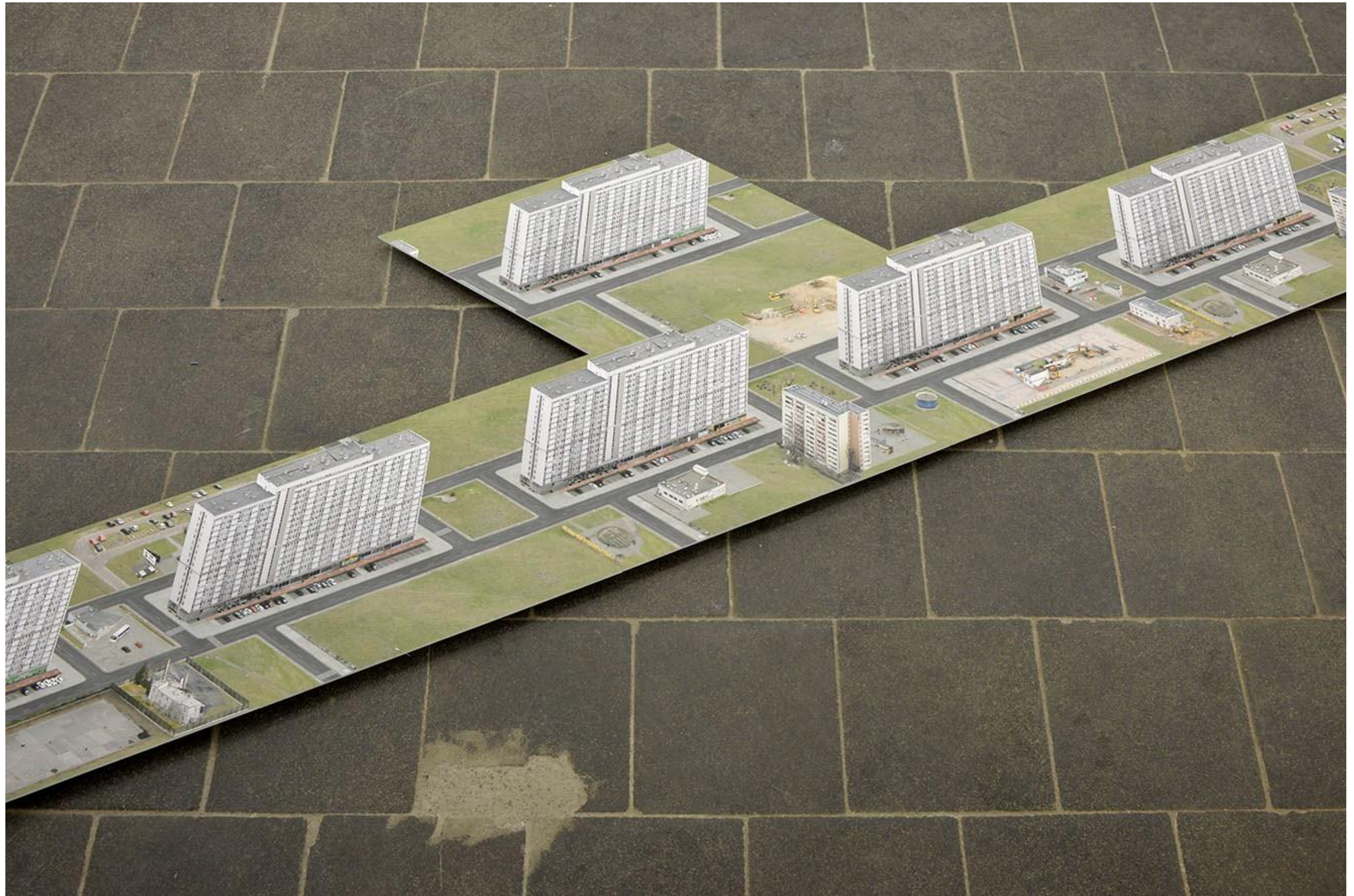

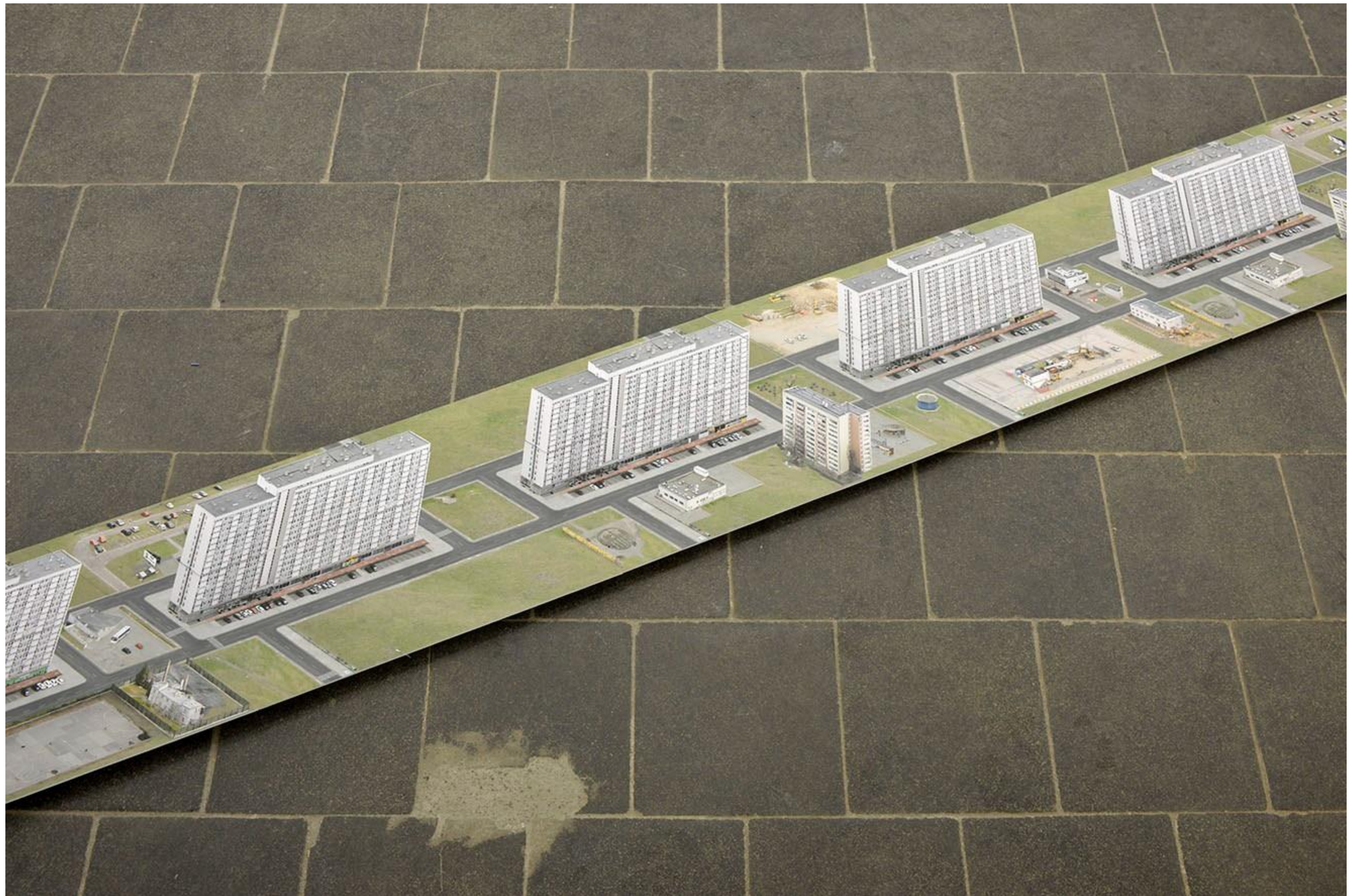





















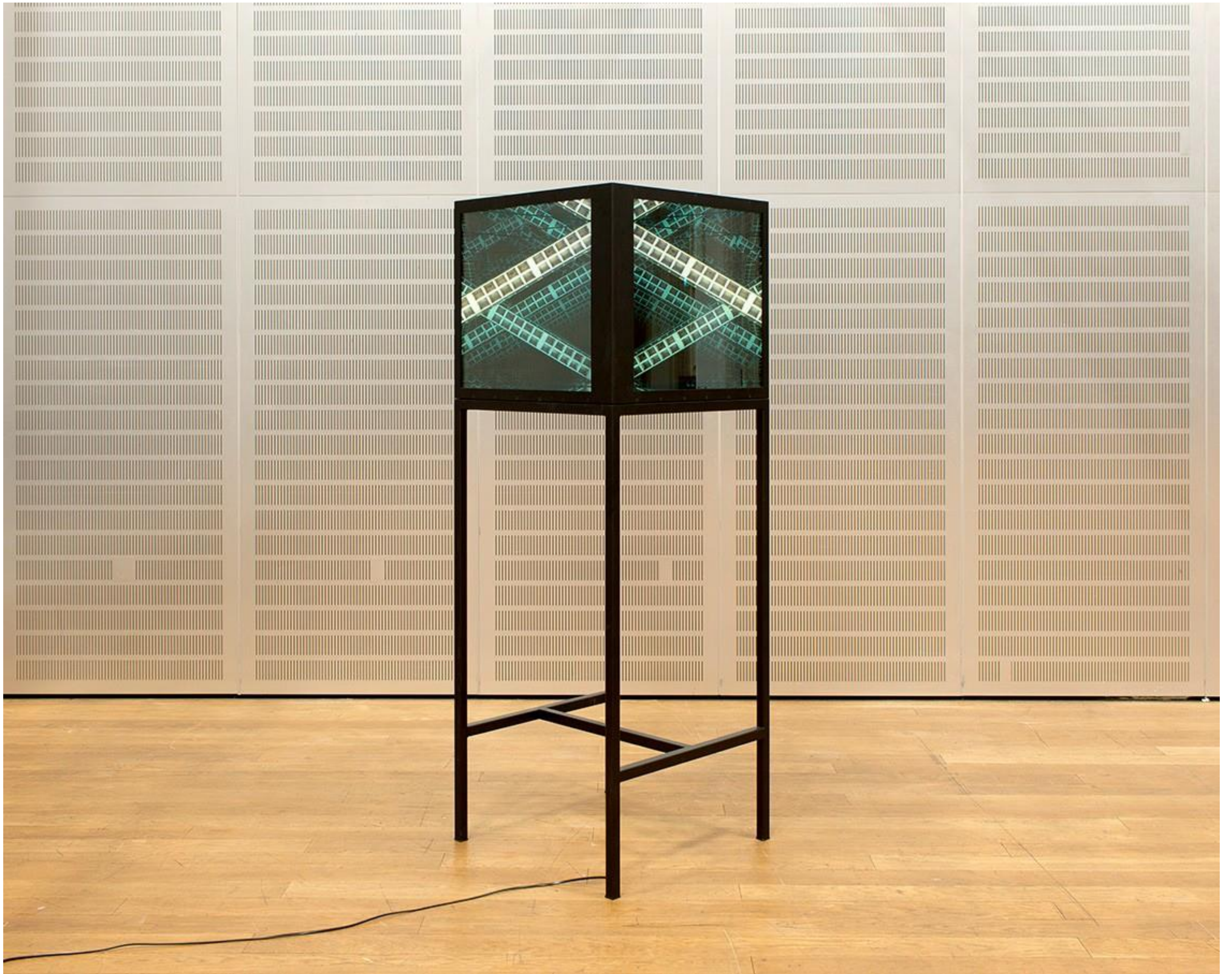



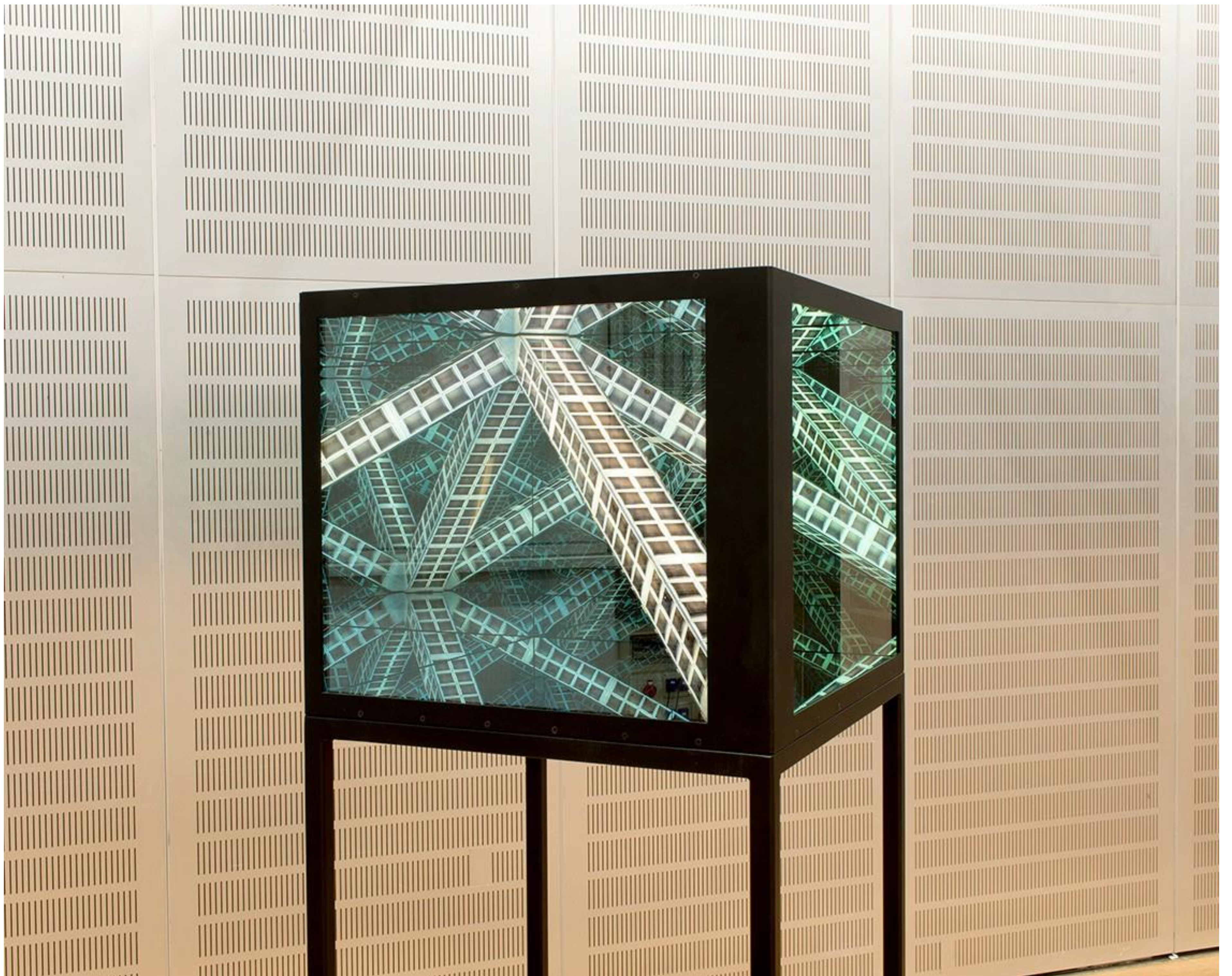

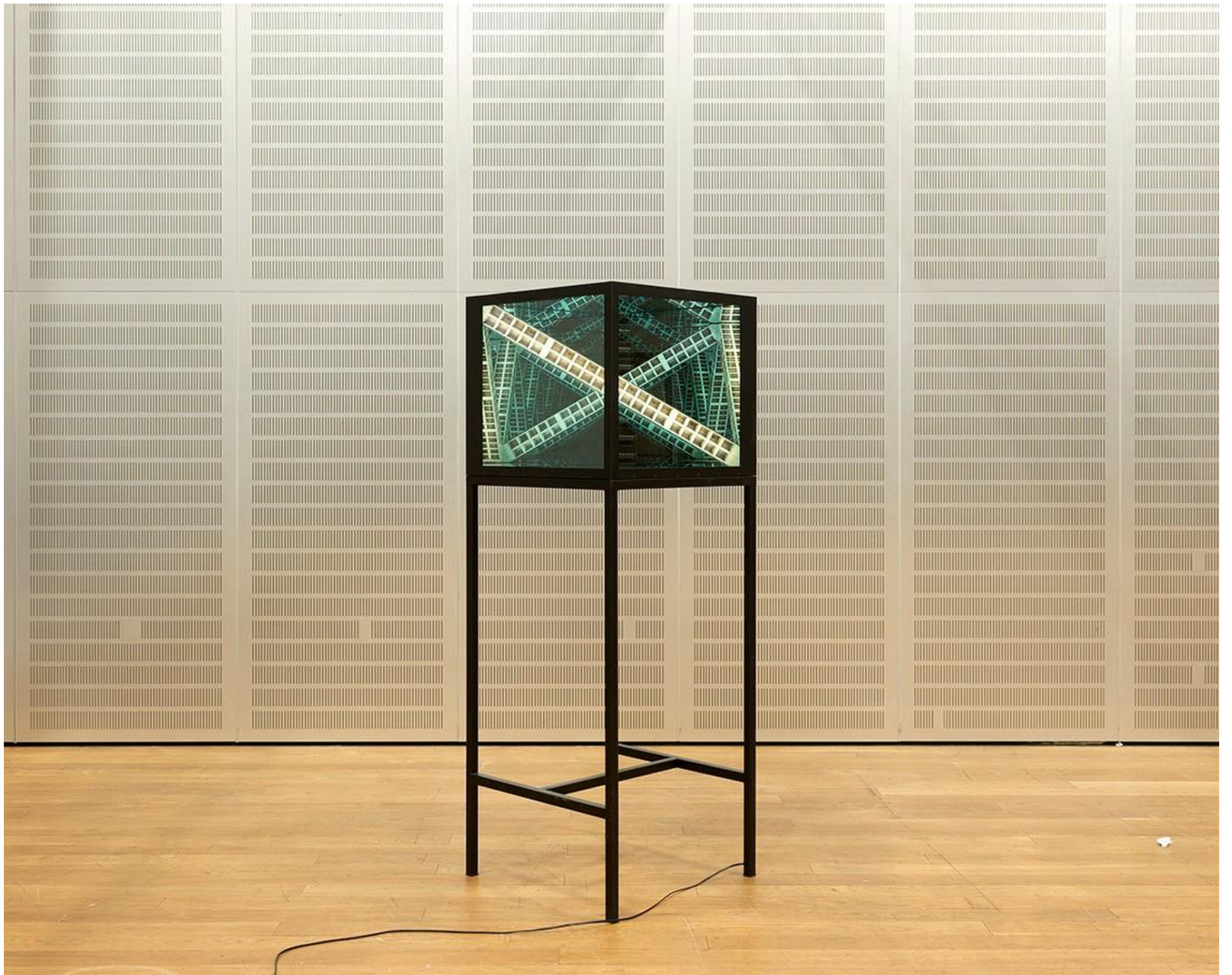

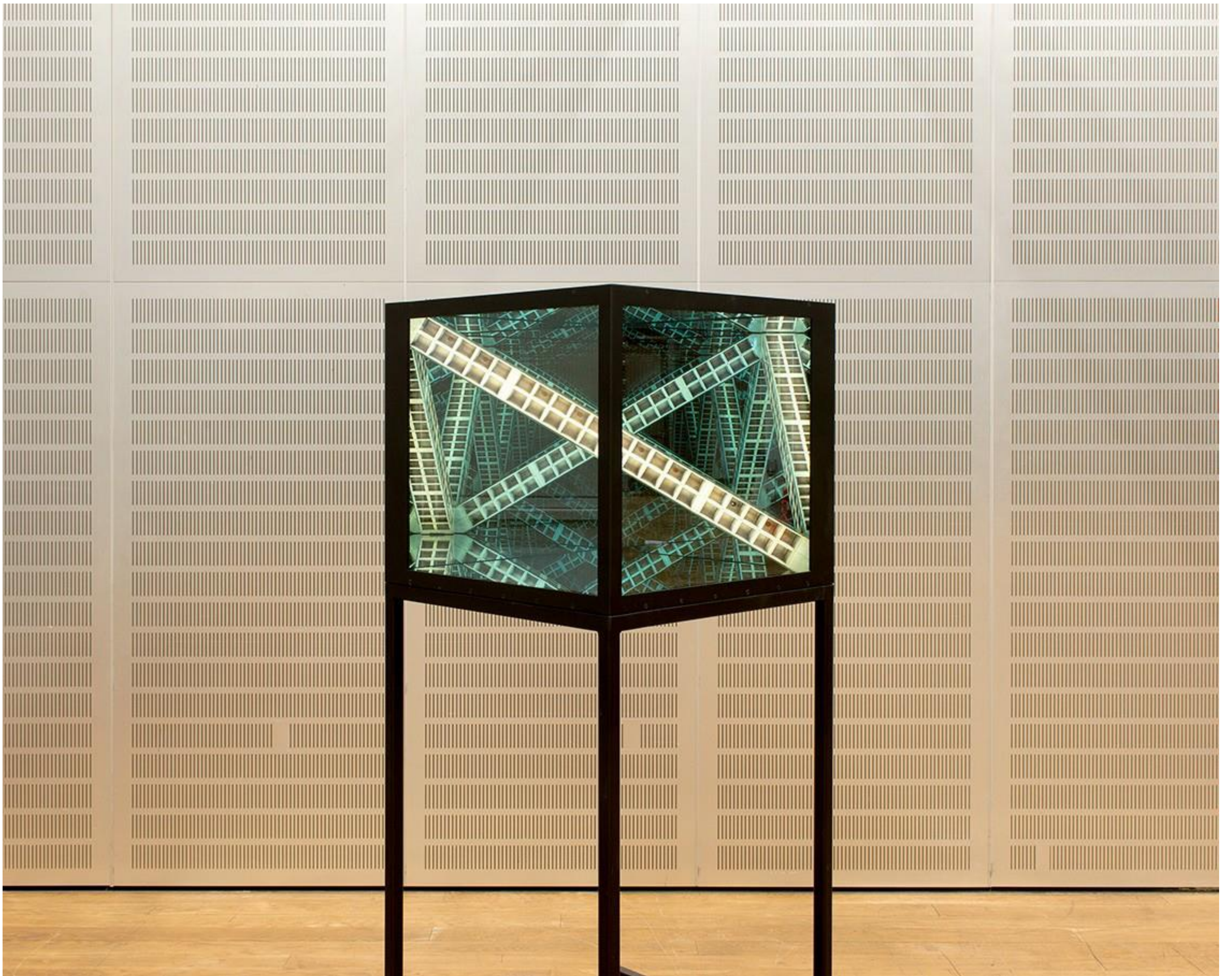



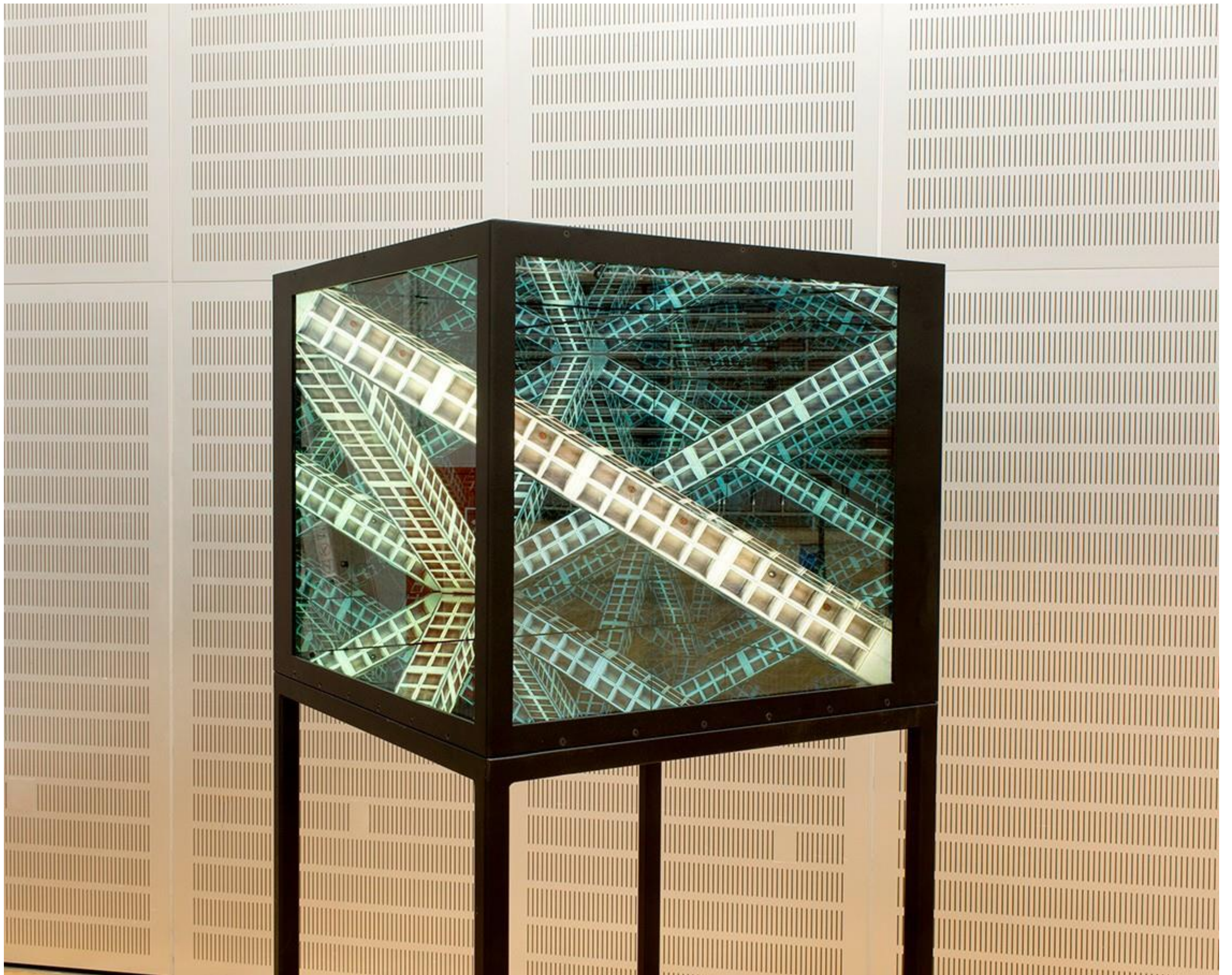

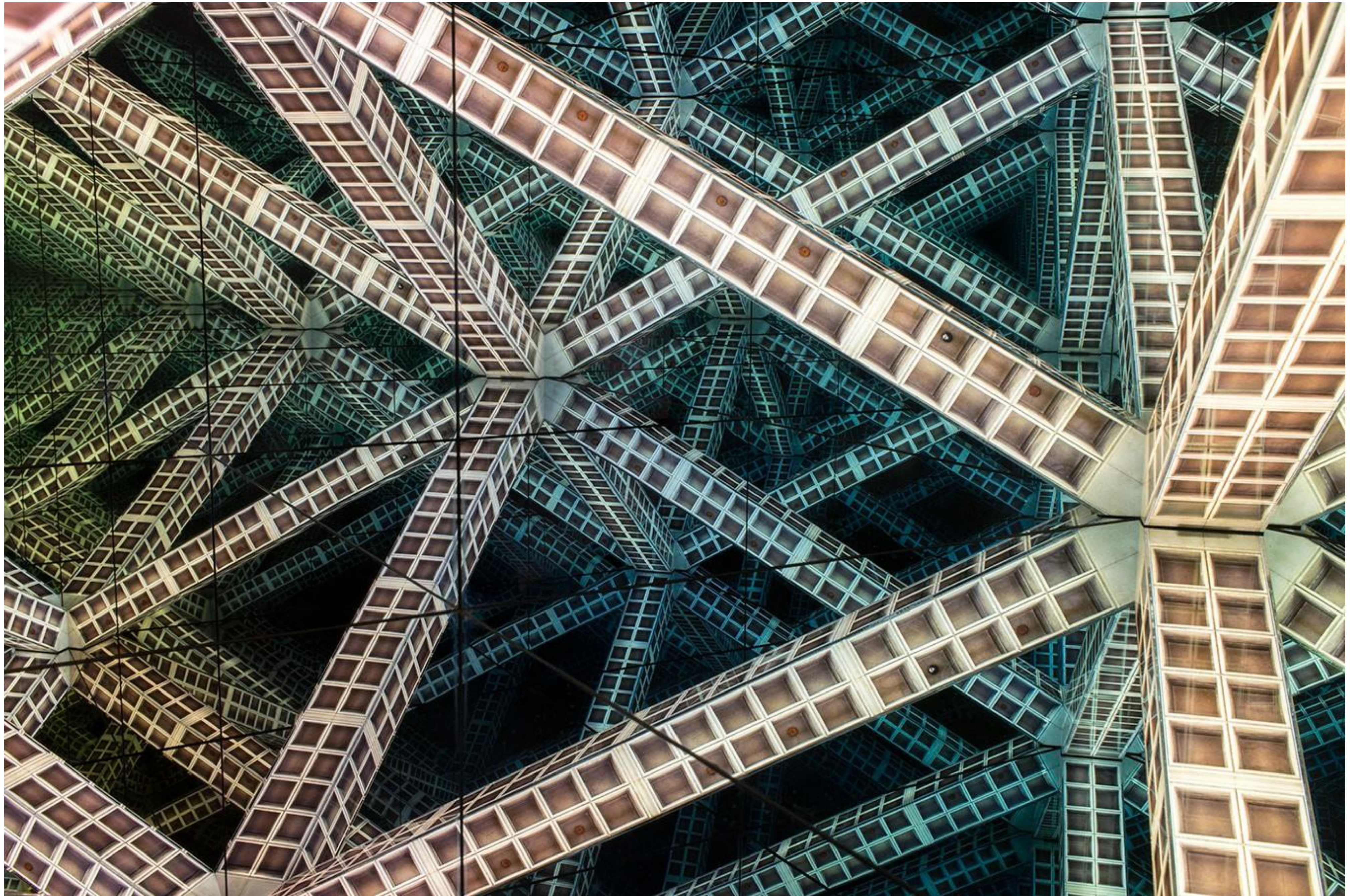

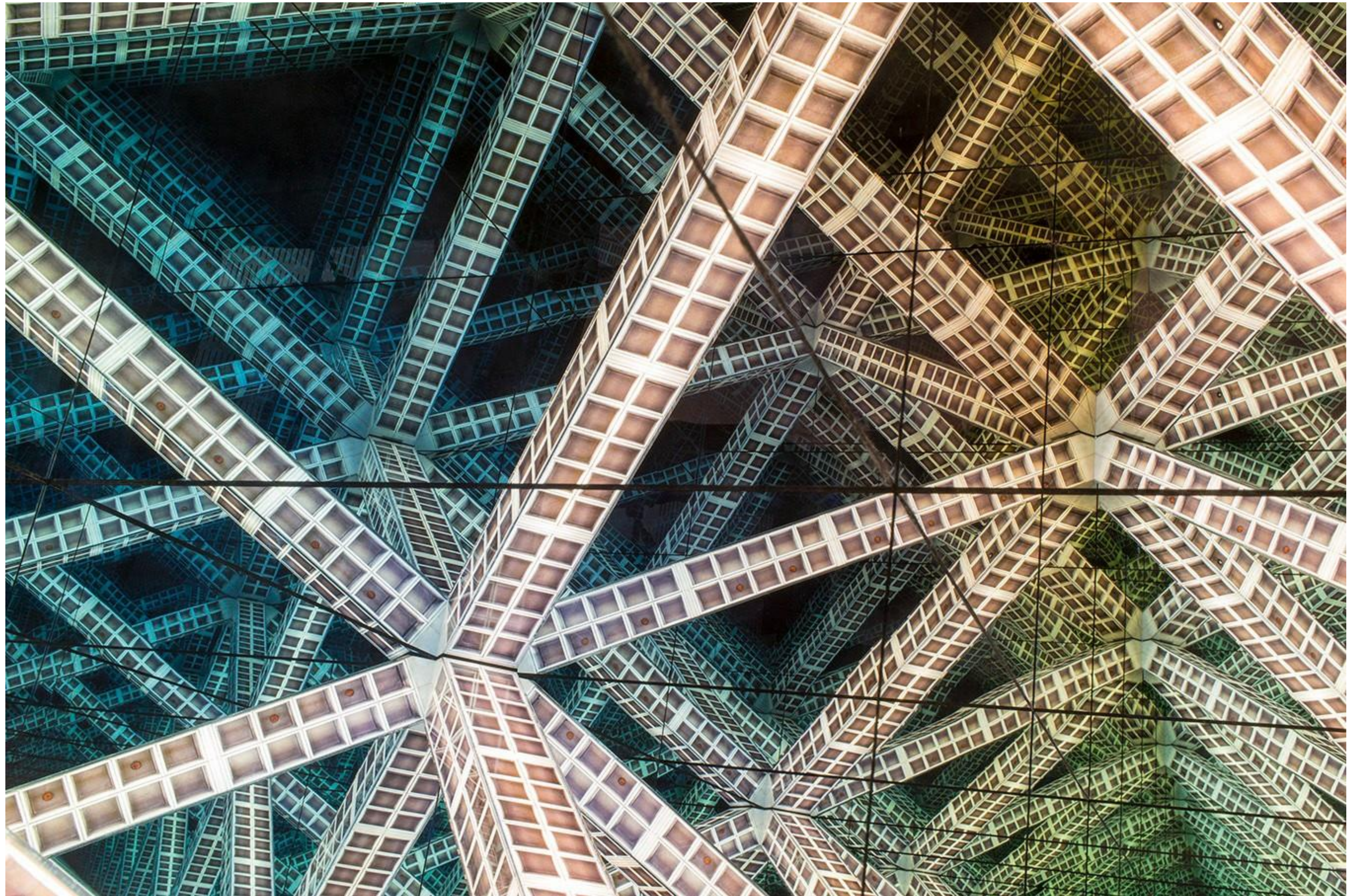

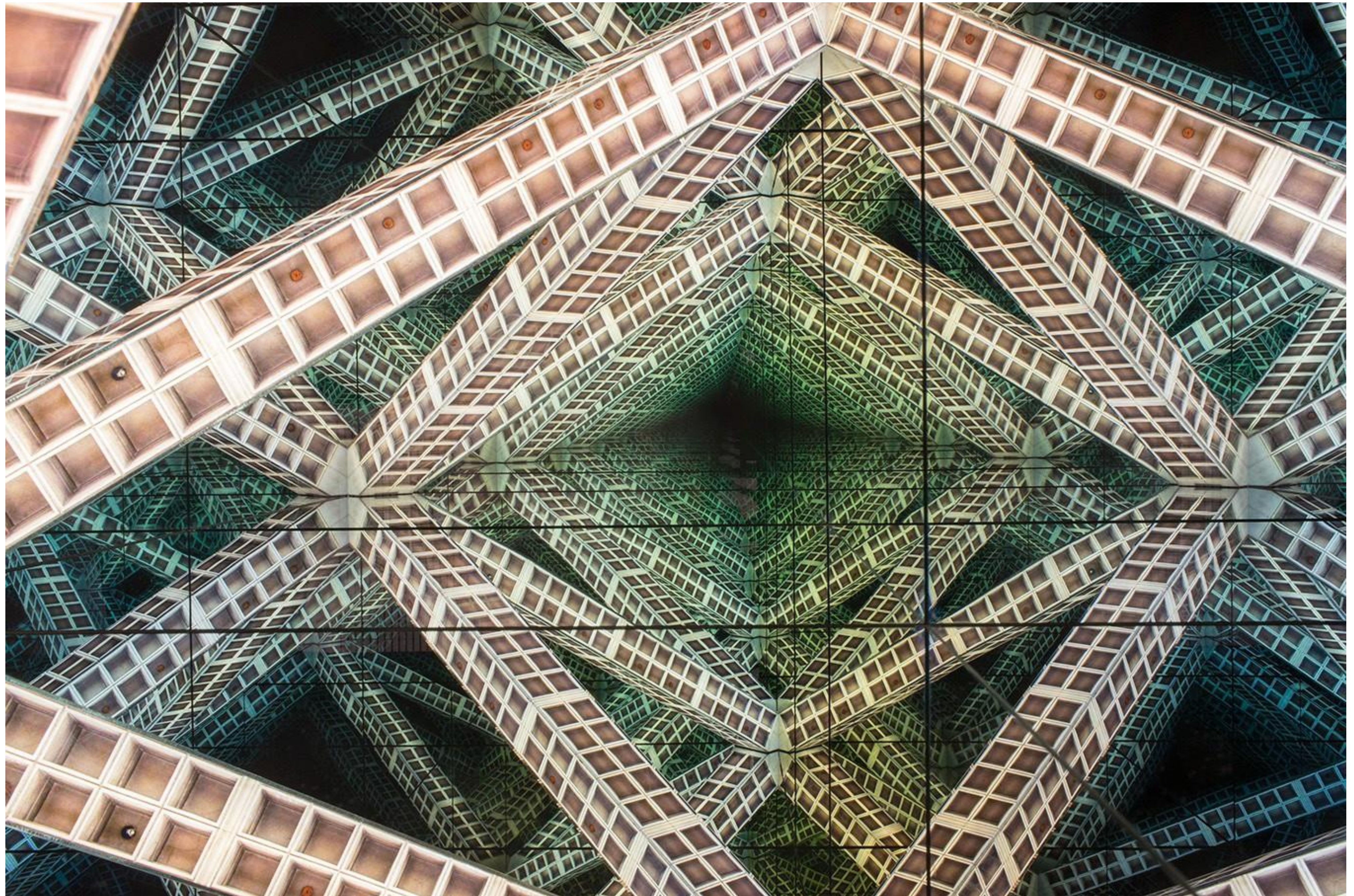

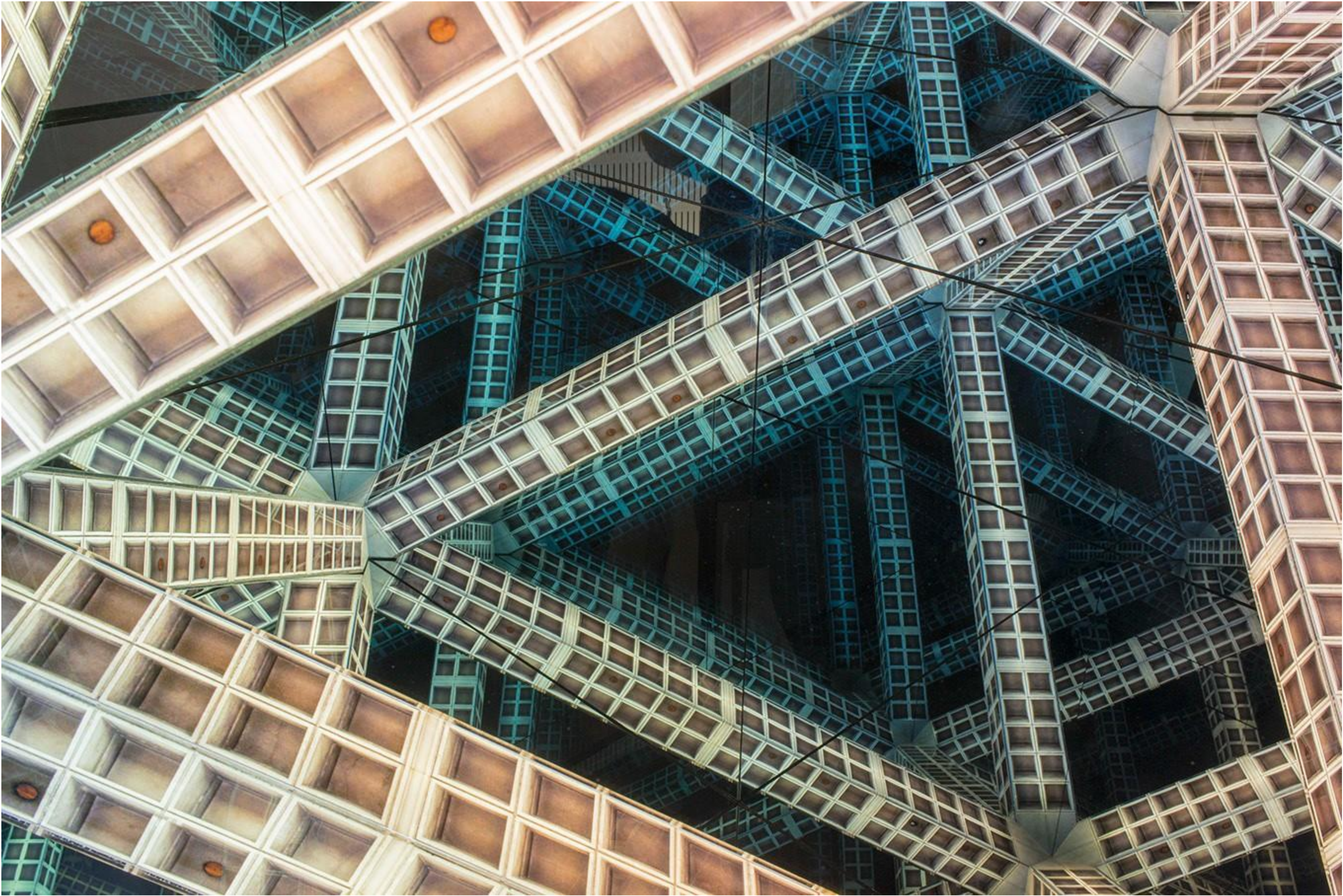

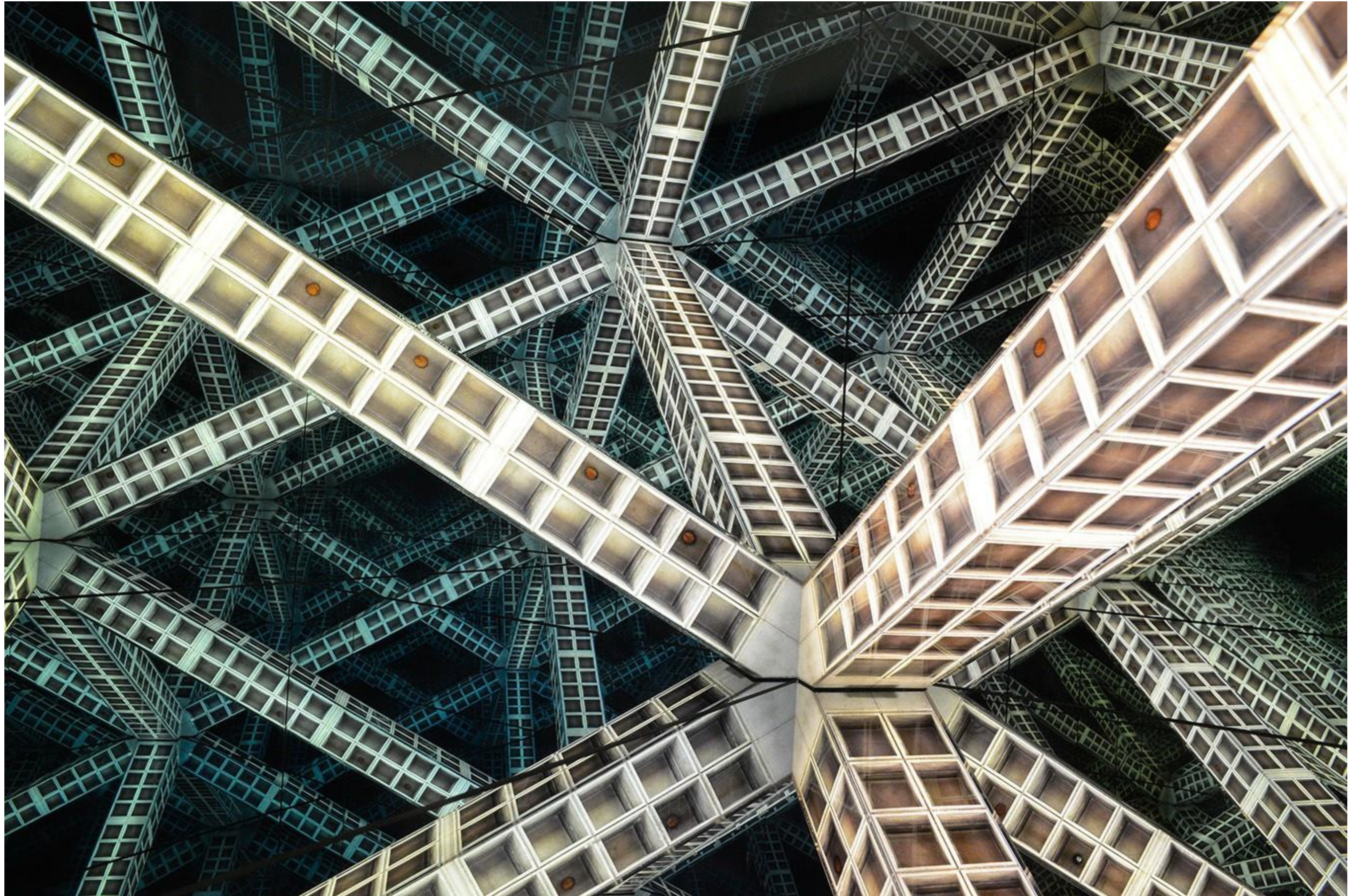











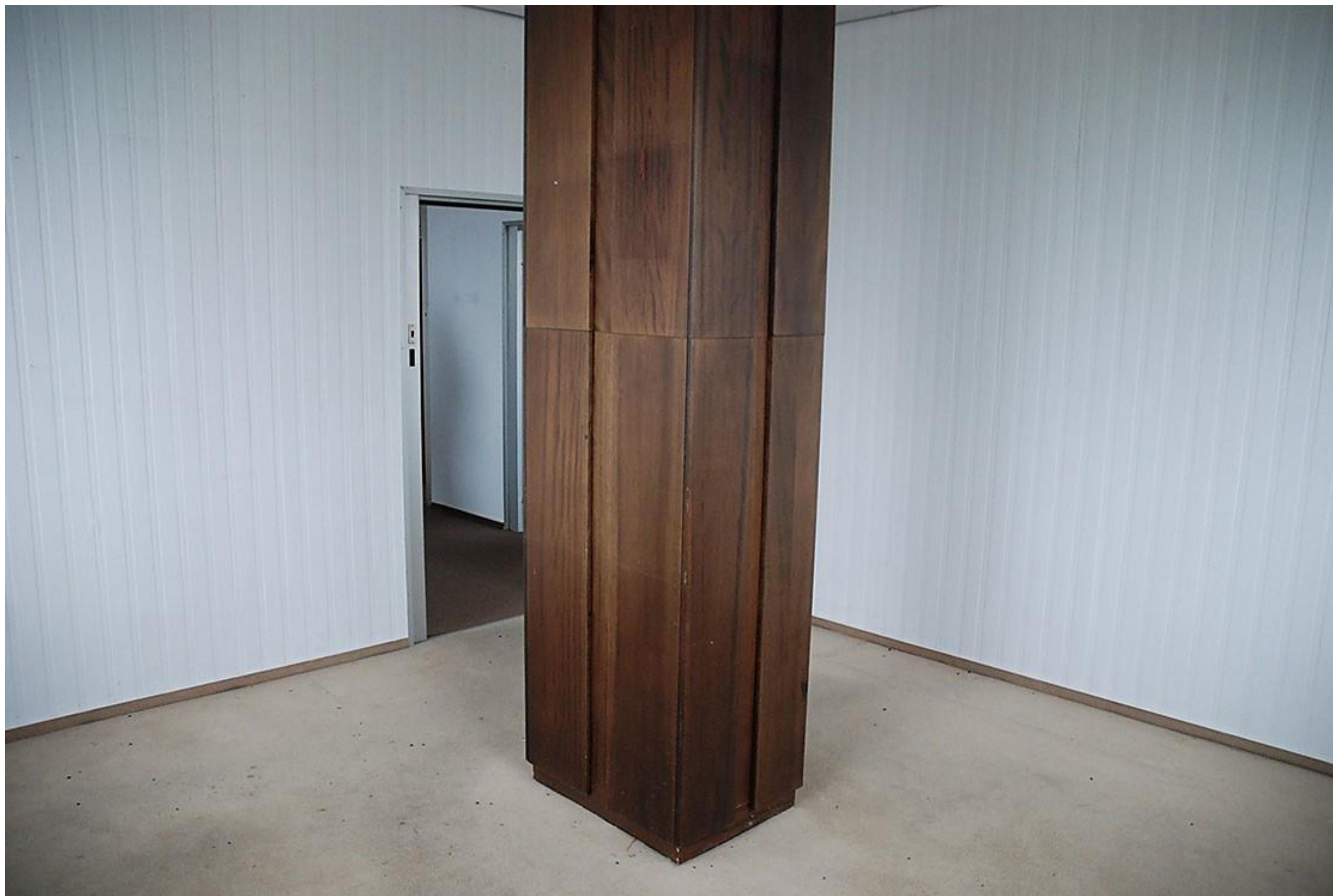



















































SZKLANA PUŁAPKA

NICOLAS GROSPIERRE

BUDYNEK CIECHU - POWĄZKOWSKA 46/50

INSTALACJA CZYNNA OD 22 DO 31 MARCA 2010 R., CODZIENNIE OD 14 DO 17

