



ASEF

SPEAKER SERIES

Predavanje bomo pričeli ob 19:03

asef.net

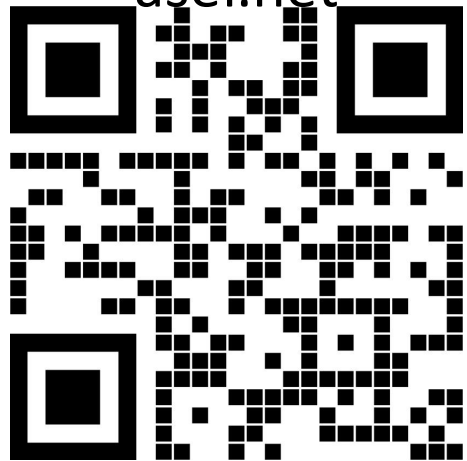

- ASEF štipendijski program:
 - 10 tedenski raziskovalni obisk v tujini
 - ASEF tutorstvo
 - Delavnice, predavanja
 - Team building, izleti, ostali dogodki...
- ASEF Speaker Series



“Dinamično življenje kavitacije.”



Prof. Dr. Matevž Dular

Univerza v Ljubljani.

Četrtek, 16. februarja, ob 19. uri CET.

Predavanje bo potekalo v Prešernovi dvorani, SAZU (Novi trg 4).

Predvajali ga bomo tudi preko spleta.



ASEF

AMERICAN SLOVENIAN
EDUCATION FOUNDATION

Prof. Dr. Matevž Dular



**Znanstveni
sodelavec**

2004

2005

Doktorat iz strojništva
UL + TU Darmstadt

Raziskovalni projektni vodja
Hidria

2012

Izredni profesor
Fakulteta za strojništvo

2017

Znanstveni svetnik

Redni profesor
Fakulteta za strojništvo

Vprašanja

- **KDAJ?** Na koncu predavanja
- **KAKO?** Vprašanja zastavite na www.sli.do s kodo **ASEFSpeakerSeries**

Joining as a participant?

Enter code here



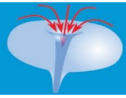

Ljubljana, 16.2.2023

ASEF

Dinamično življenje kavitacije

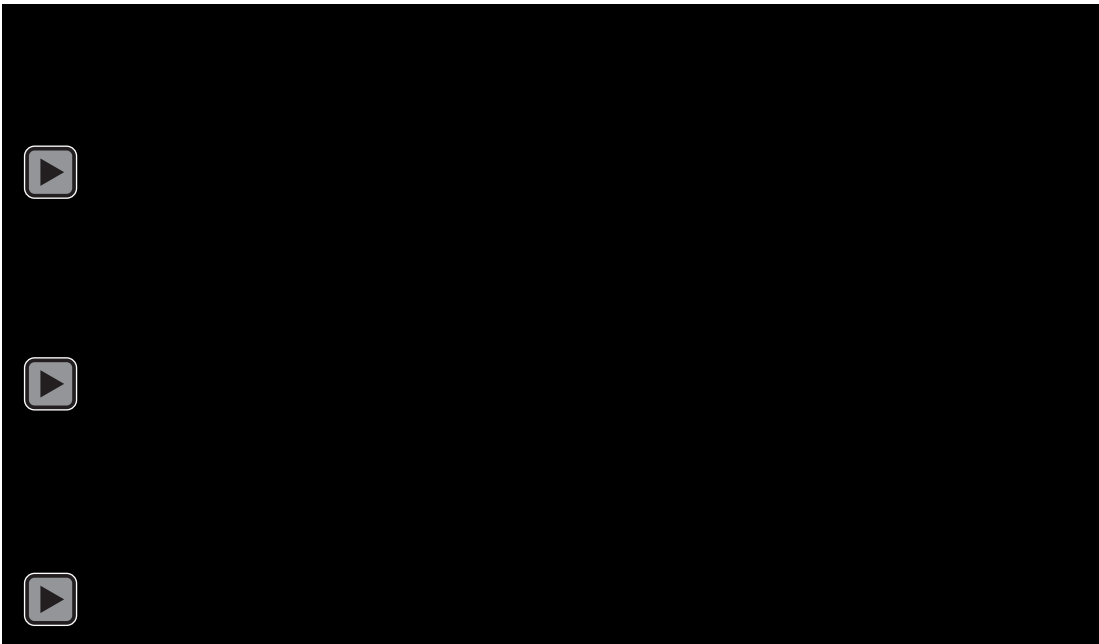

Matevž Dular

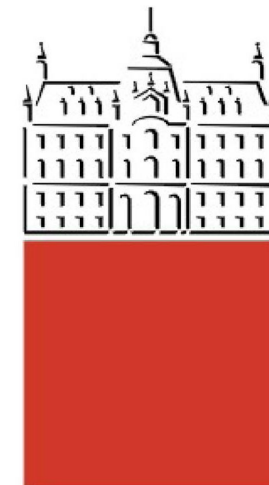

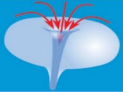

Ljubljana, 16.2.2023

ASEF

Dinamično življenje kavitacije

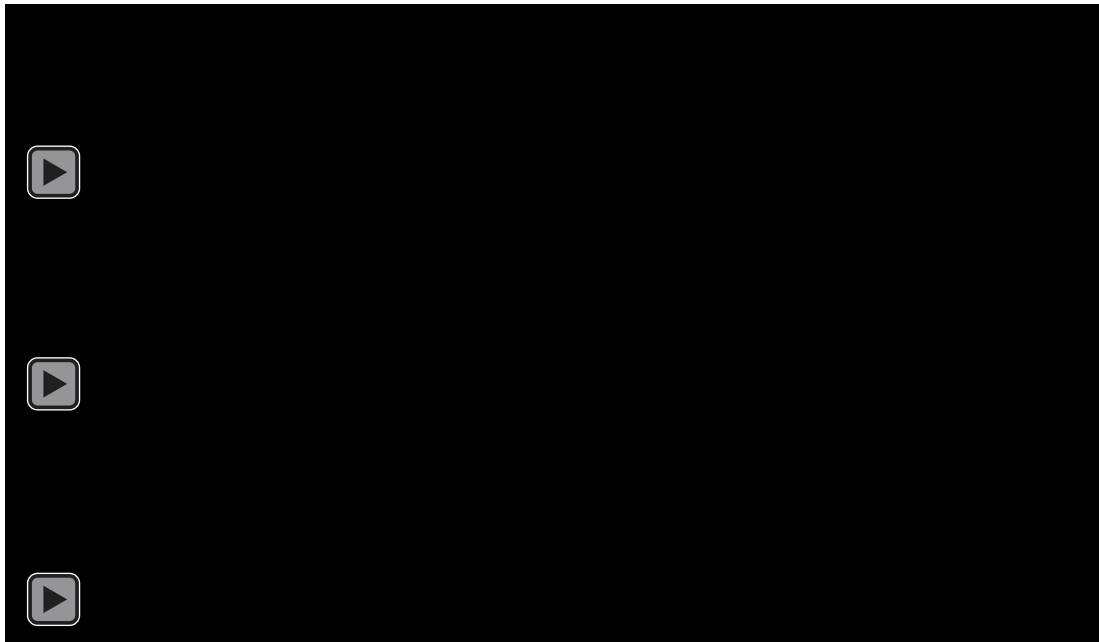

Matevž Dular

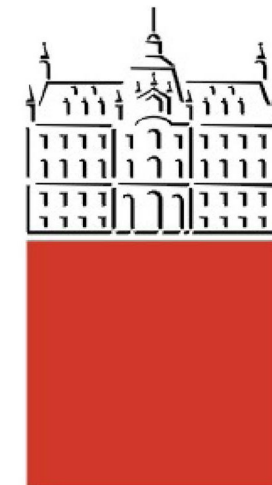

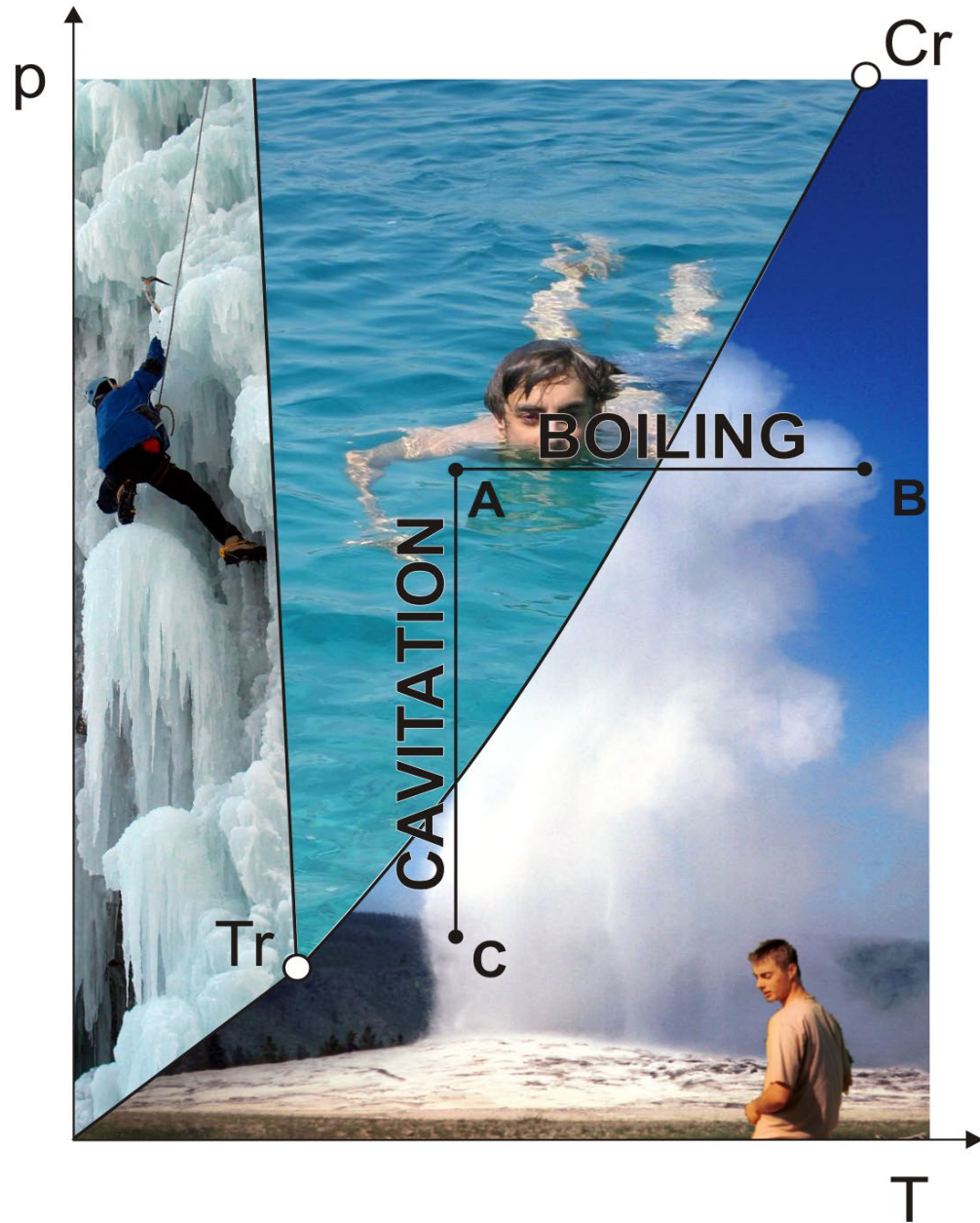

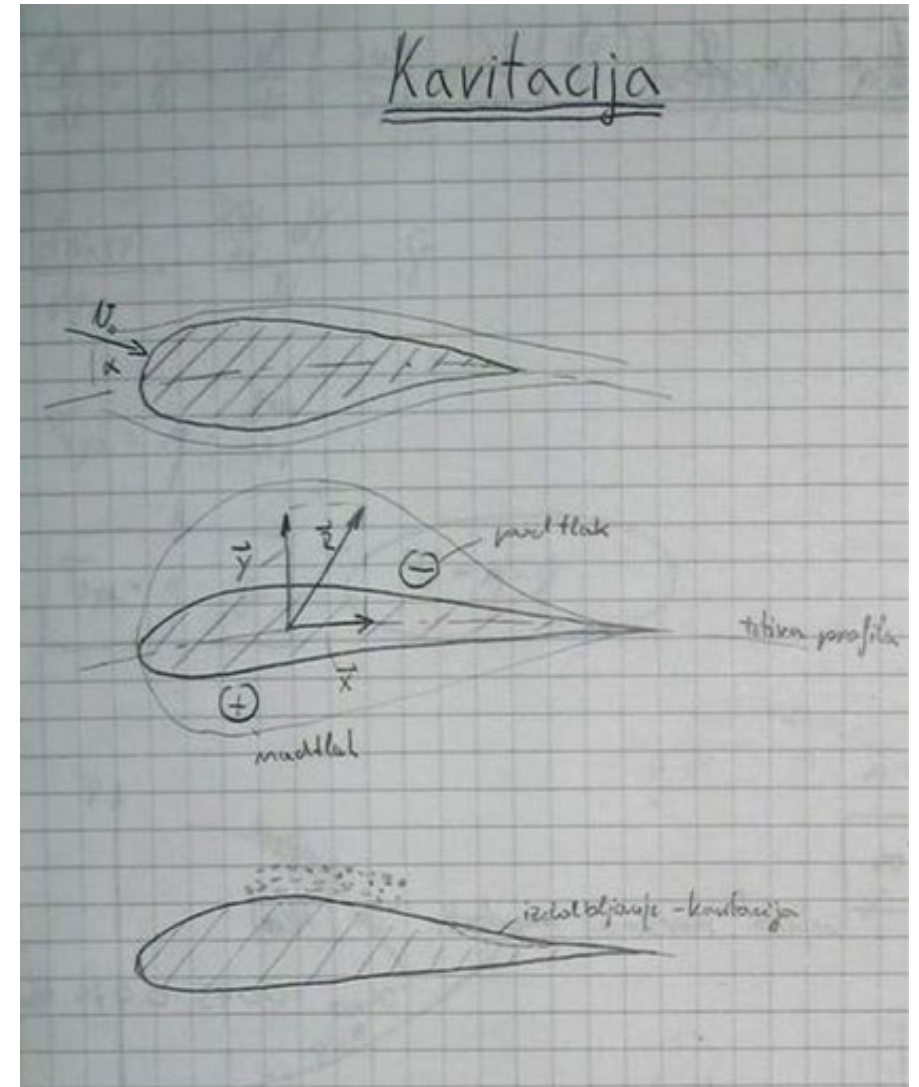
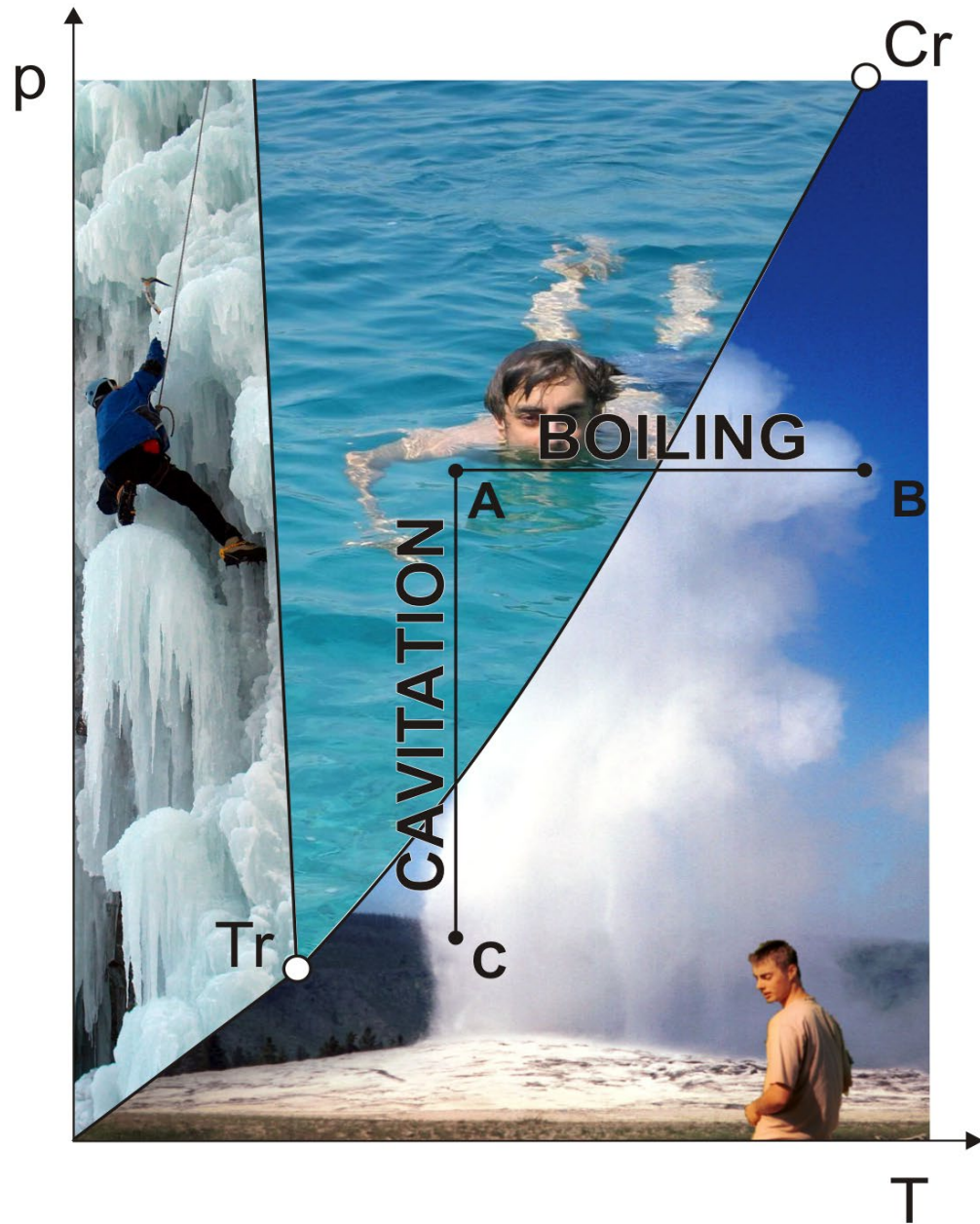

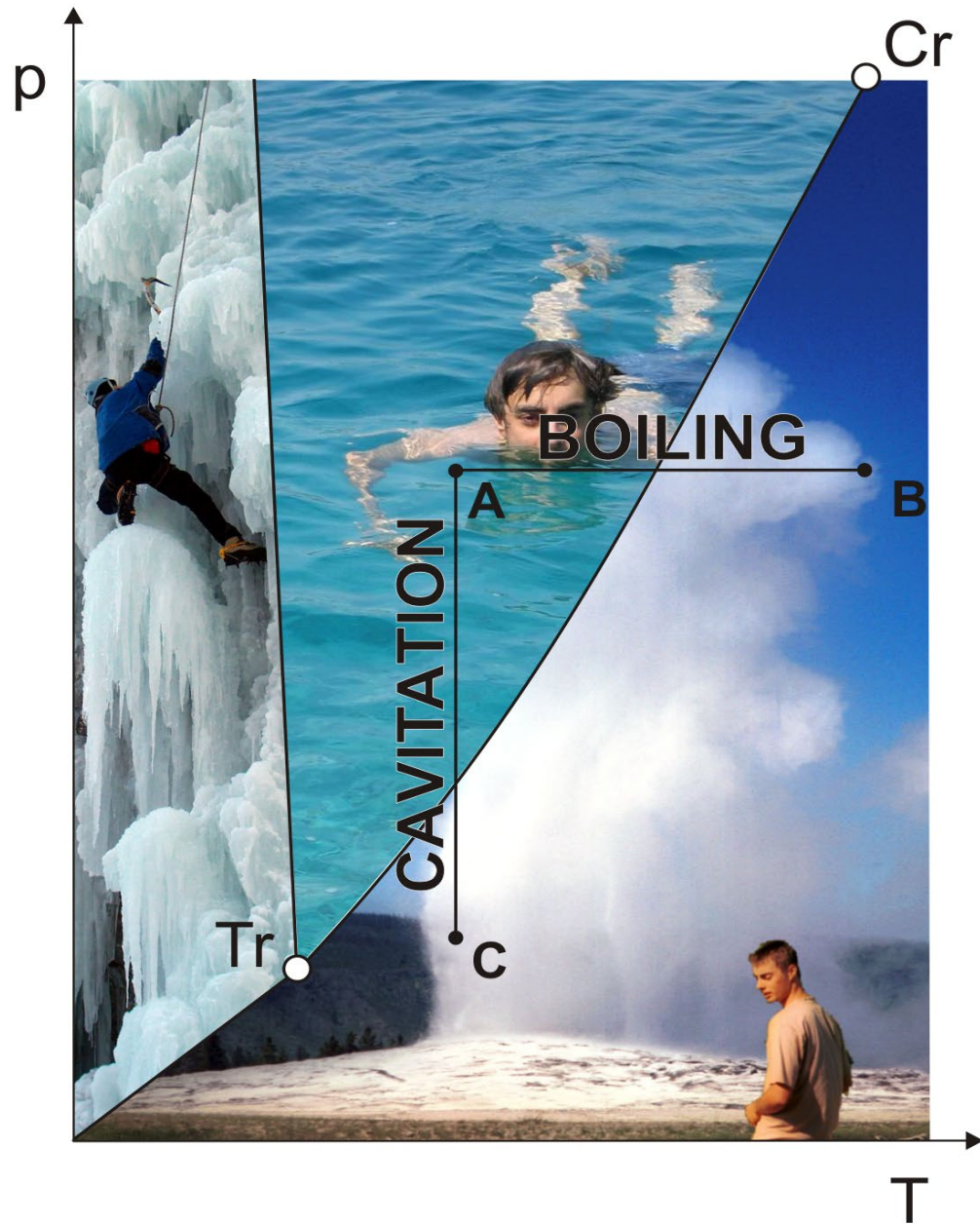

Veliki splošni leksikon, DZS, 1997

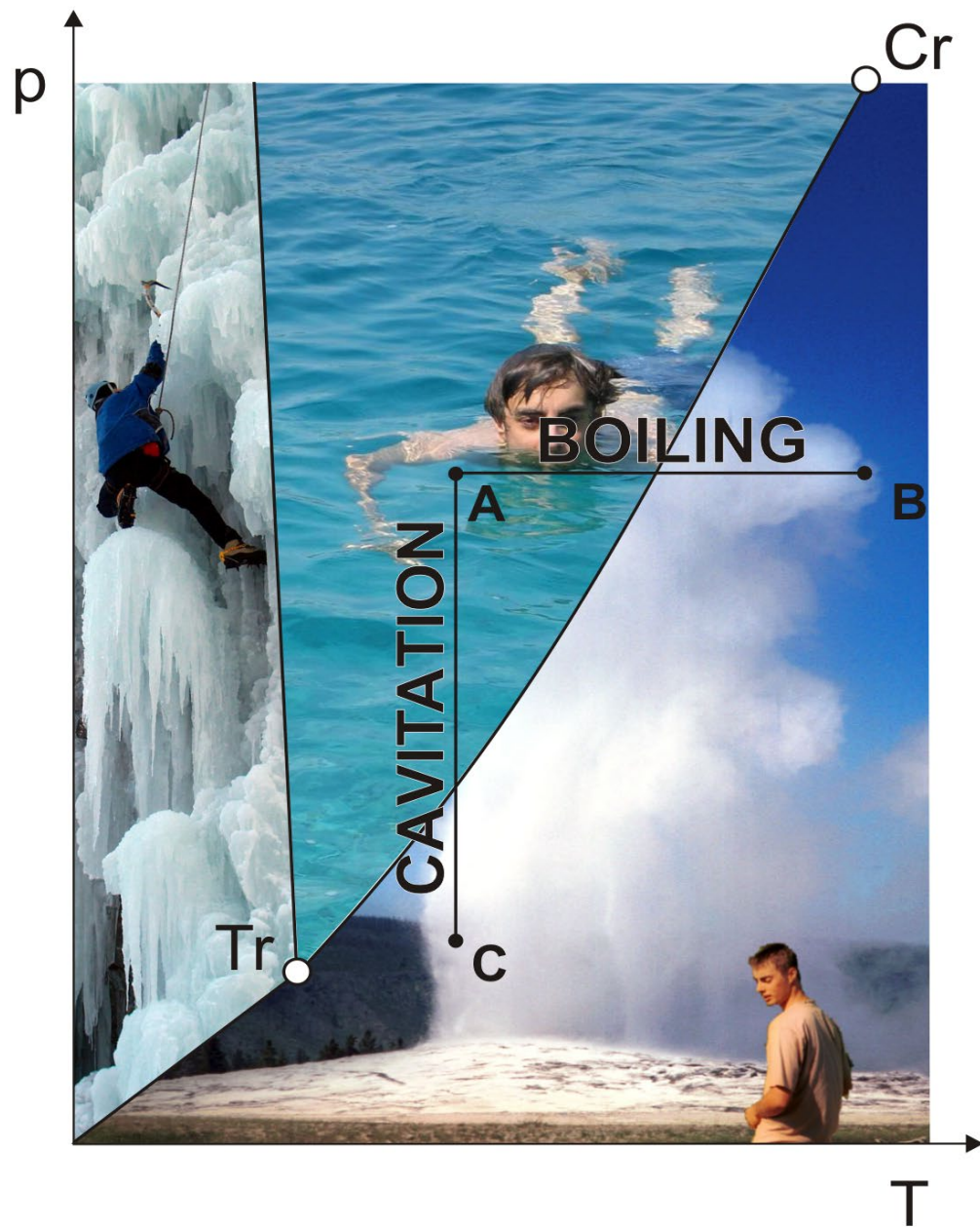

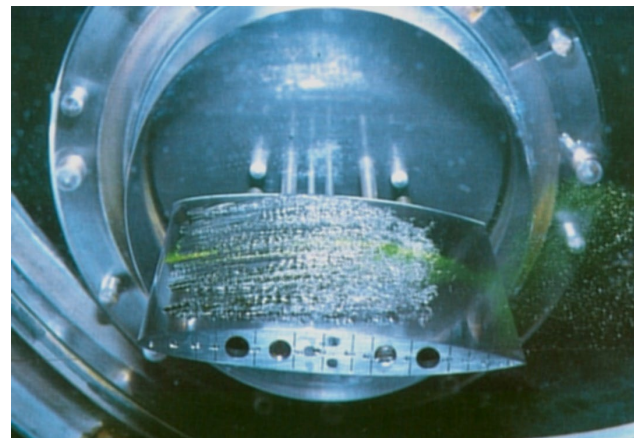
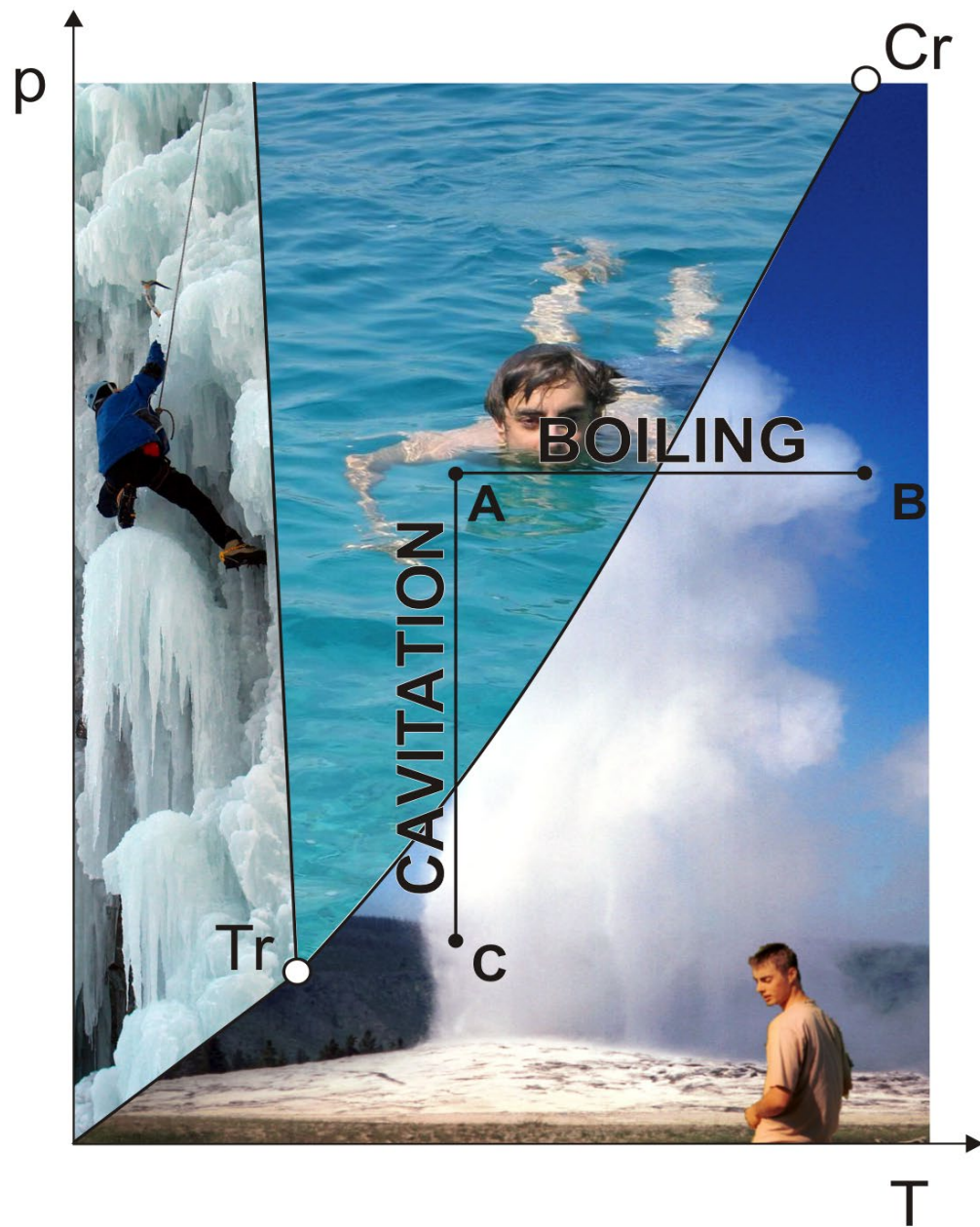

FRANC, Jean-Pierre. **La cavitation: mécanismes physiques et aspects industriels**. EDP Sciences, pp.582, 1995

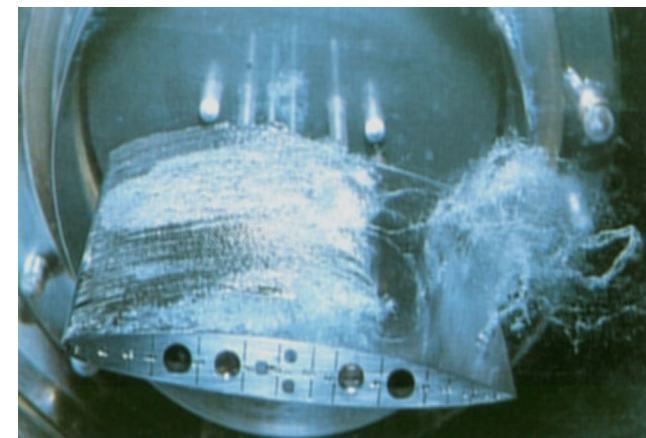
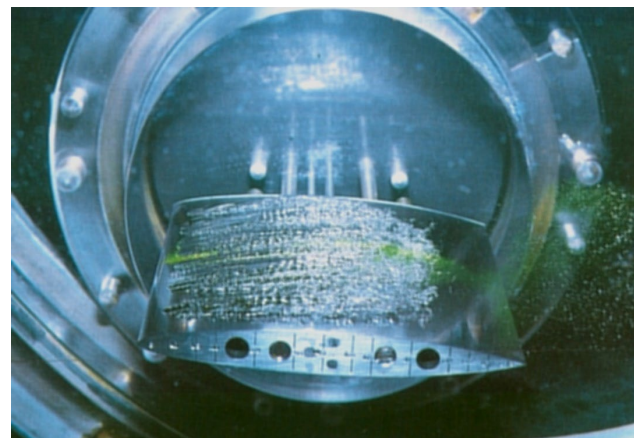
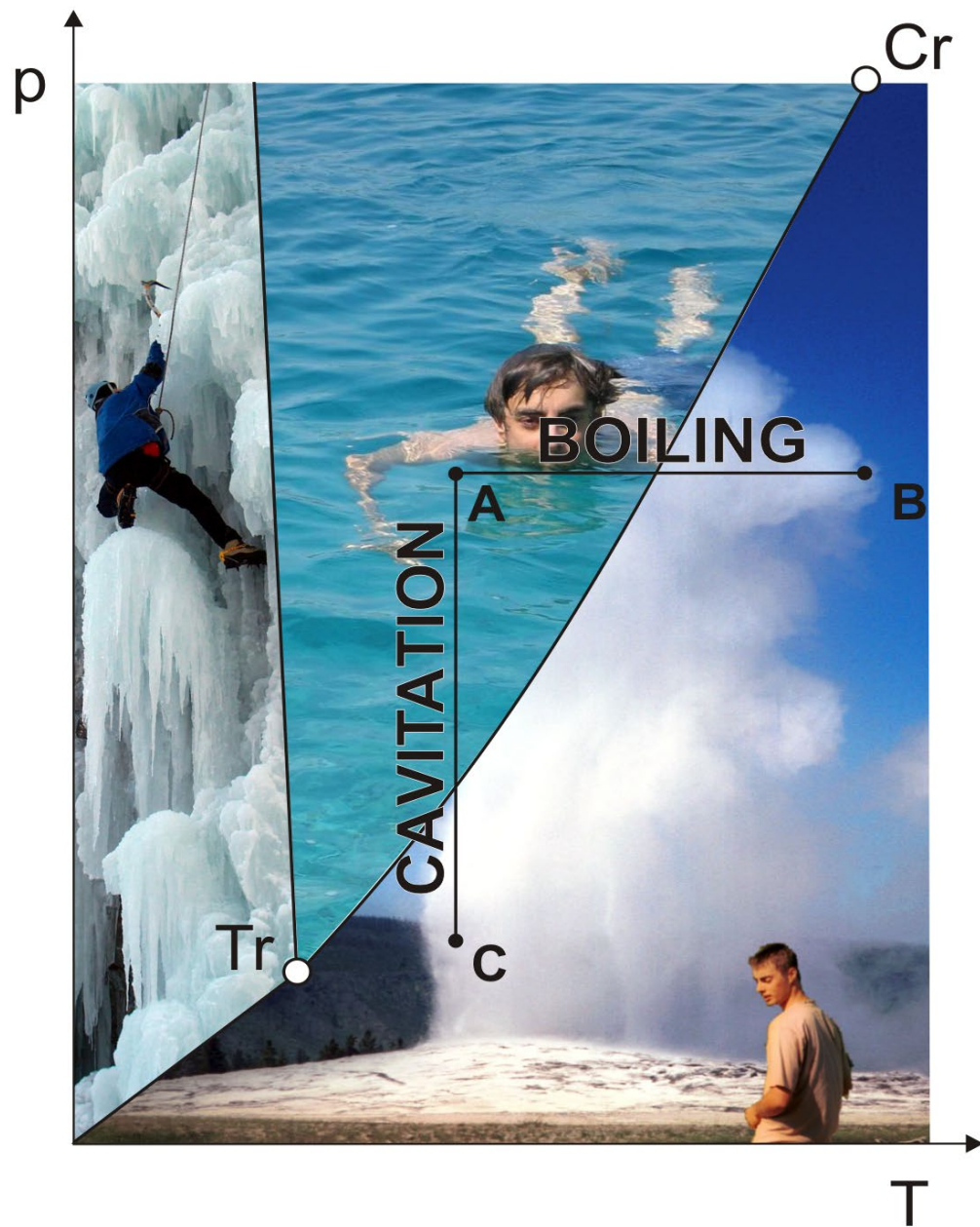

FRANC, Jean-Pierre. **La cavitation: mécanismes physiques et aspects industriels**. EDP Sciences, pp.582, 1995

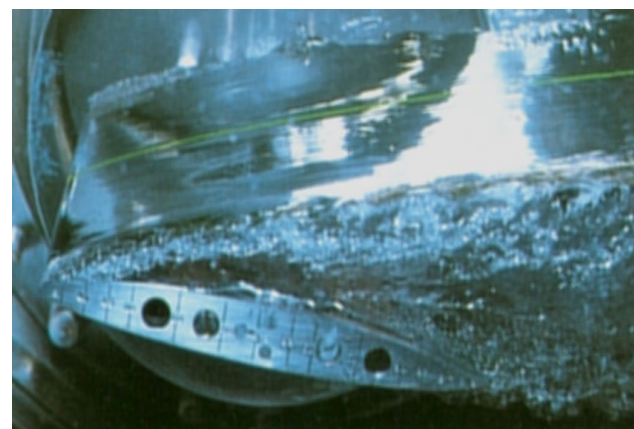
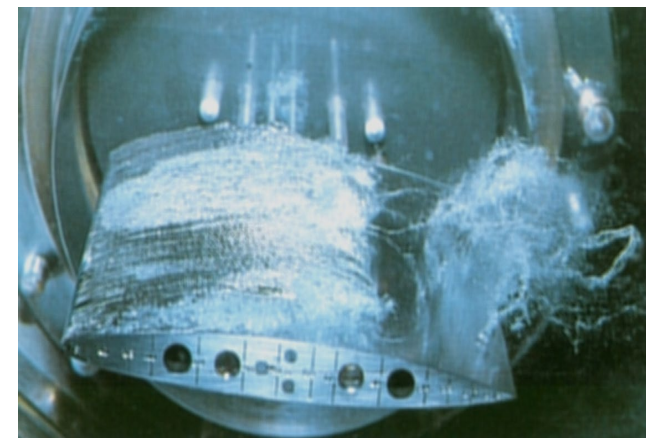
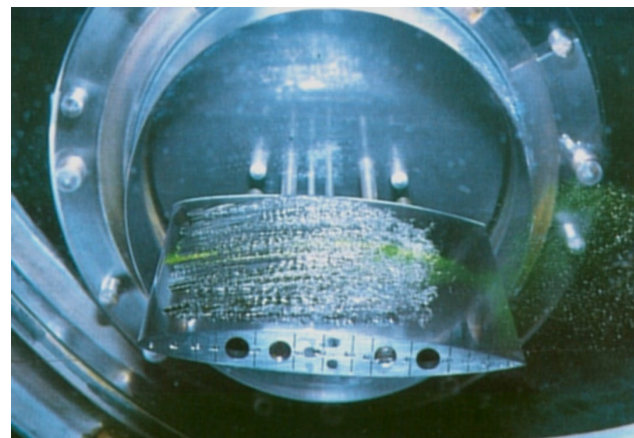
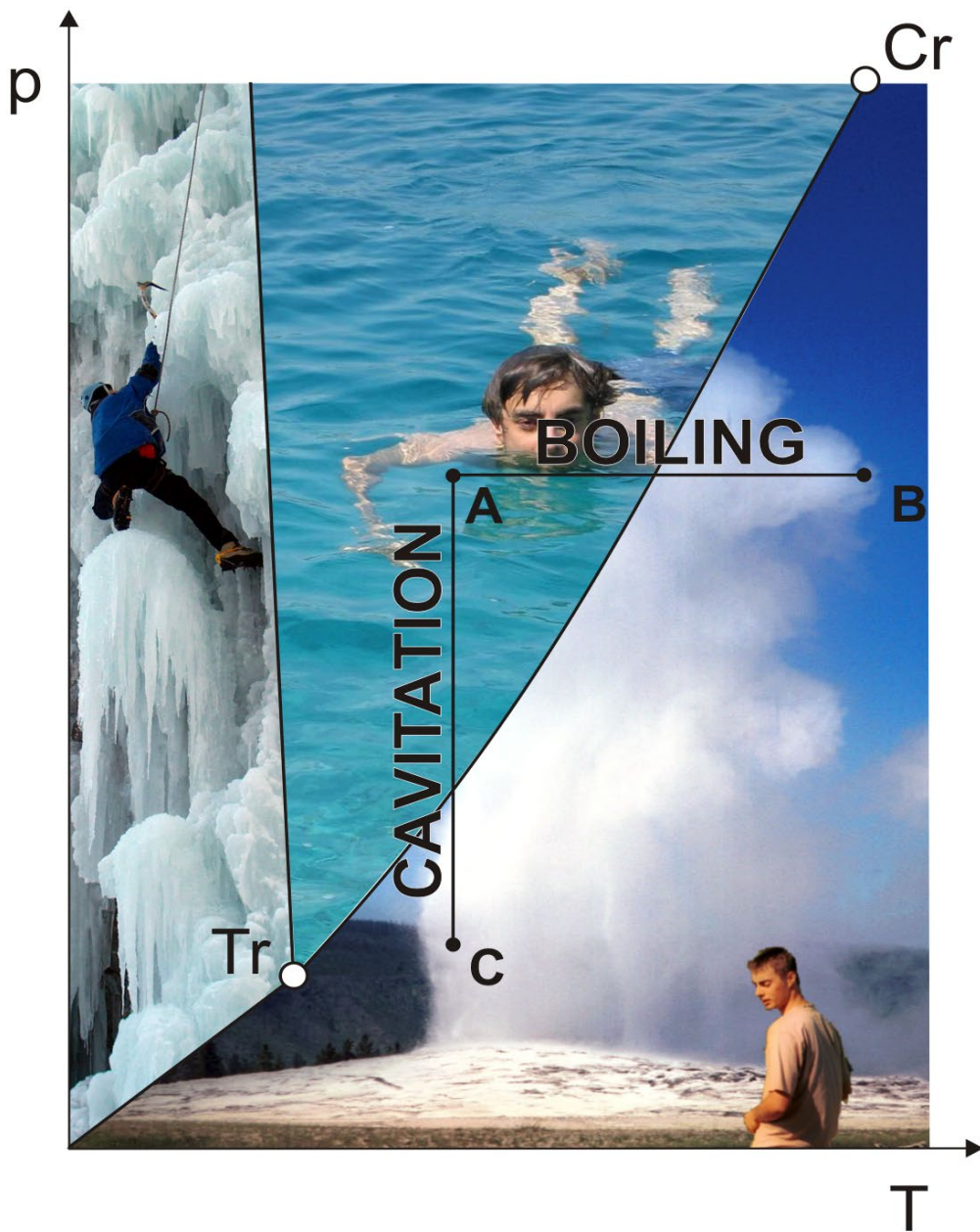

FRANC, Jean-Pierre. **La cavitation: mécanismes physiques et aspects industriels.** EDP Sciences, pp.582, 1995

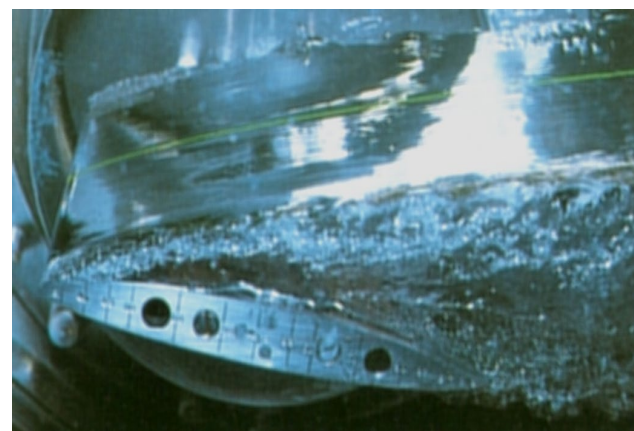
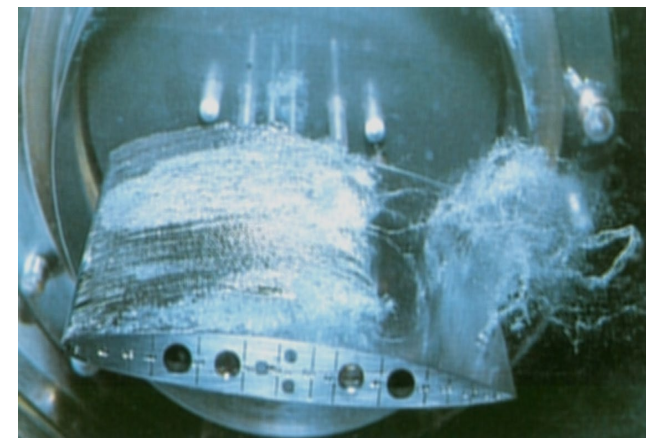
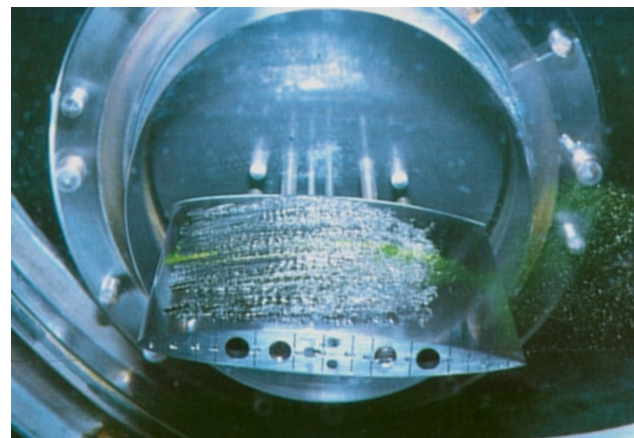
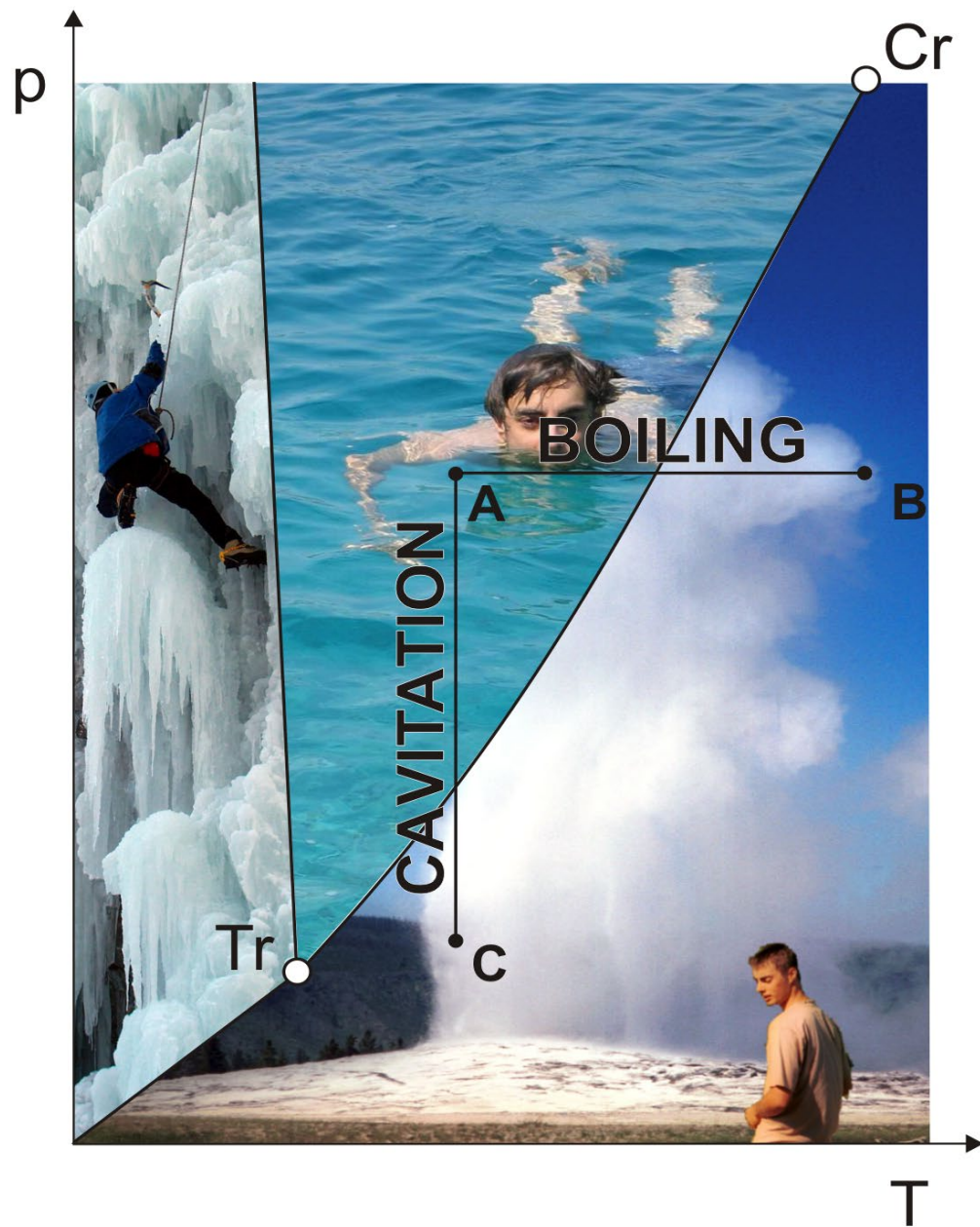

FRANC, Jean-Pierre. **La cavitation: mécanismes physiques et aspects industriels**. EDP Sciences, pp.582, 1995

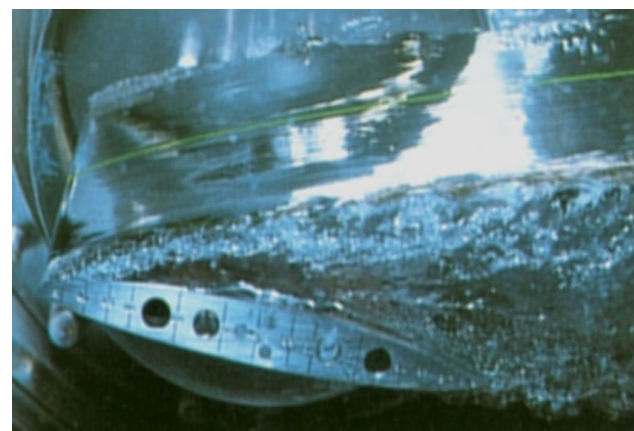
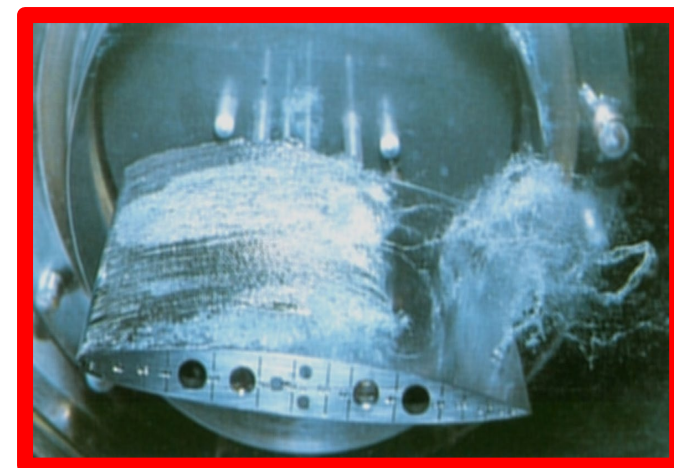
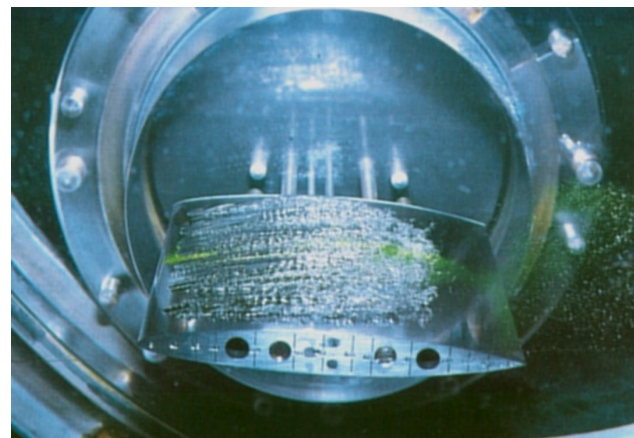
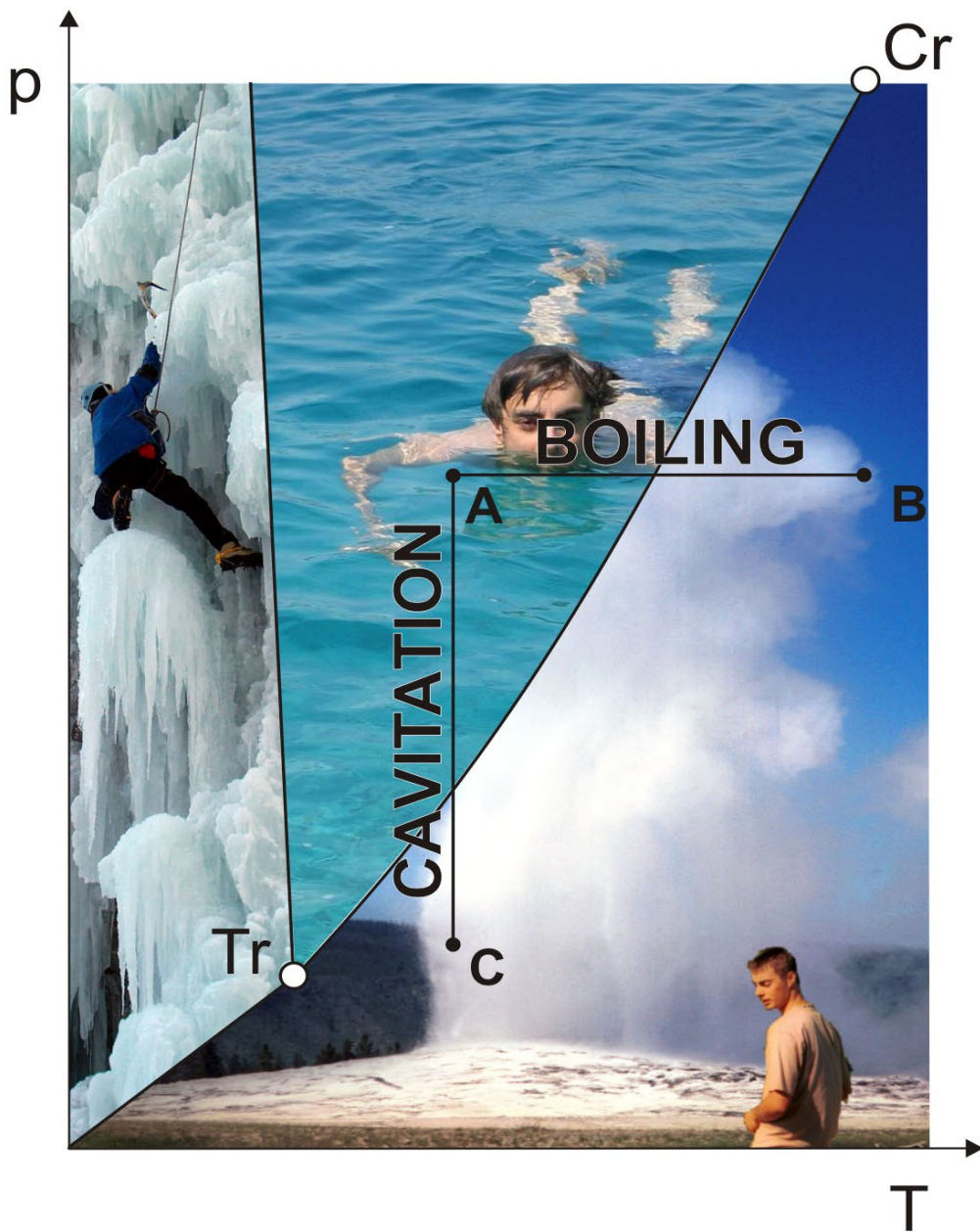

FRANC, Jean-Pierre. **La cavitation: mécanismes physiques et aspects industriels**. EDP Sciences, pp.582, 1995



Brennen. Cavitation and bubble dynamics, 1995

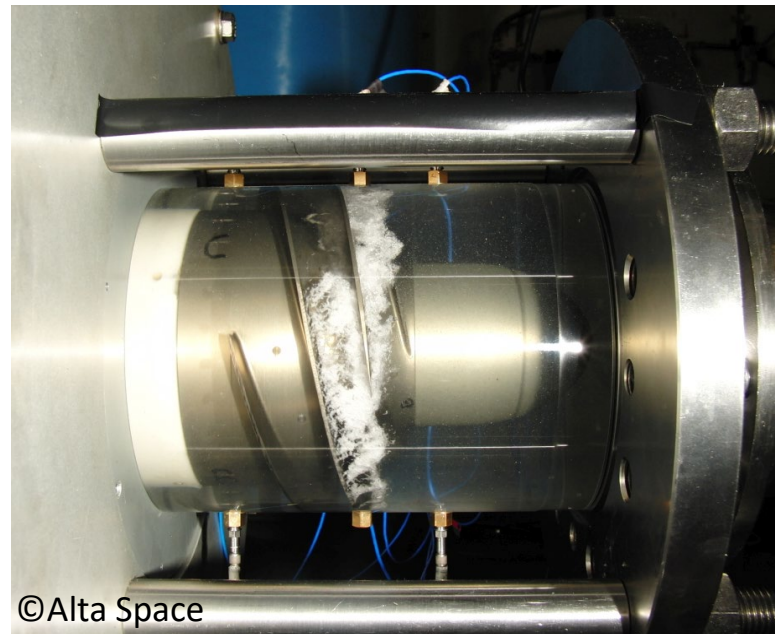
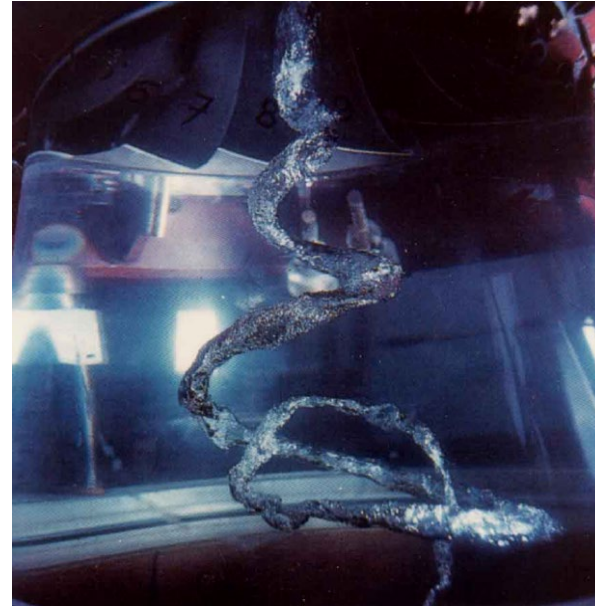

©Alta Space

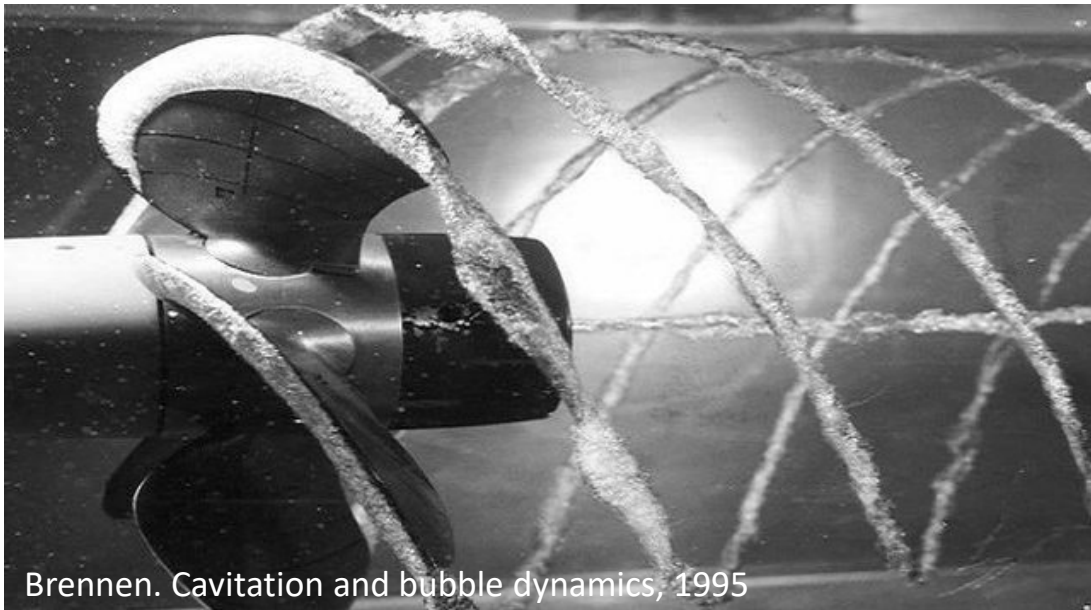

Brennen. Cavitation and bubble dynamics, 1995

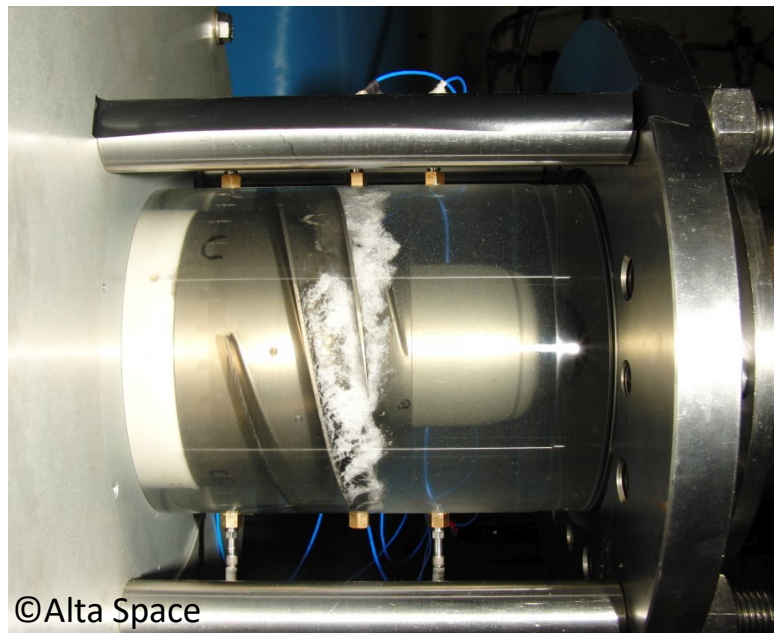
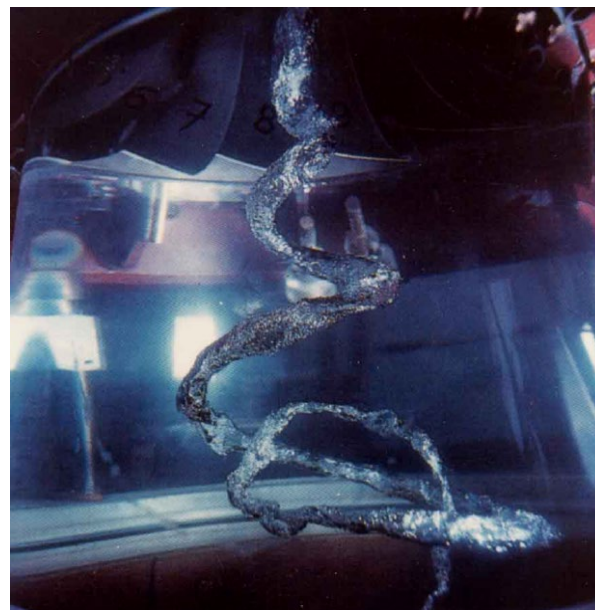

©Alta Space

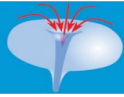

KAVITACIJSKA EROZIJA



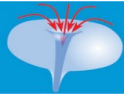

KAVITACIJSKA EROZIJA



Brennen. Cavitation and bubble dynamics, 1995



Cavitation monitoring in hydraulic machines with aid of a computer aided visualization method



Doc. Dr. Brane Širok



Cavitation monitoring in hydraulic machines with aid of a computer aided visualization method



Doc. Dr. Brane Širok



Prof. Dr. Bernd Stoffel



TECHNISCHE
UNIVERSITÄT
DARMSTADT



Cavitation monitoring in hydraulic machines with aid of a computer aided visualization method



Doc. Dr. Brane Širok



Prof. Dr. Bernd Stoffel

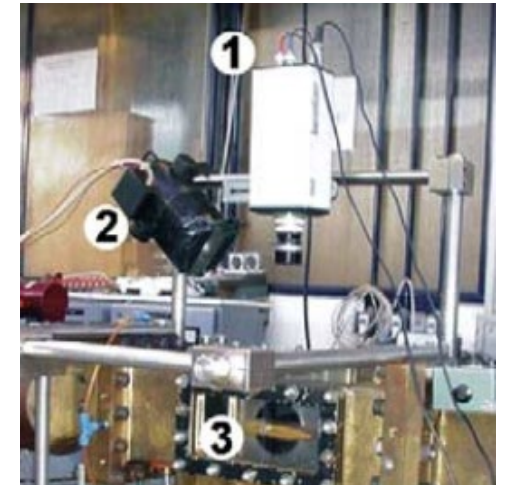
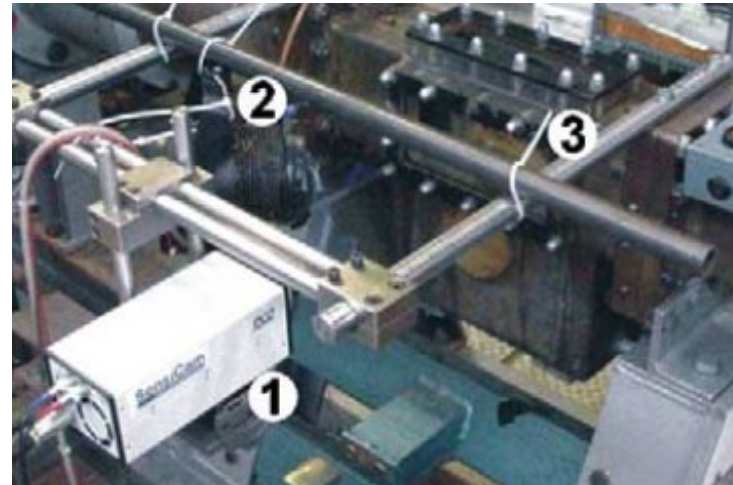

TECHNISCHE
UNIVERSITÄT
DARMSTADT

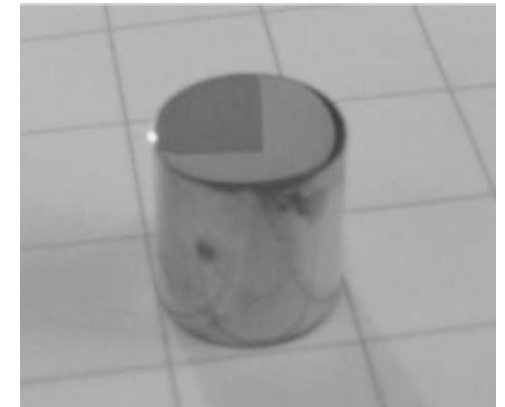
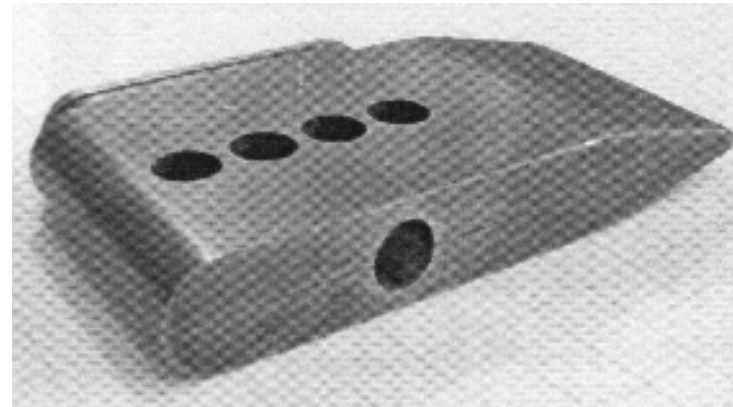

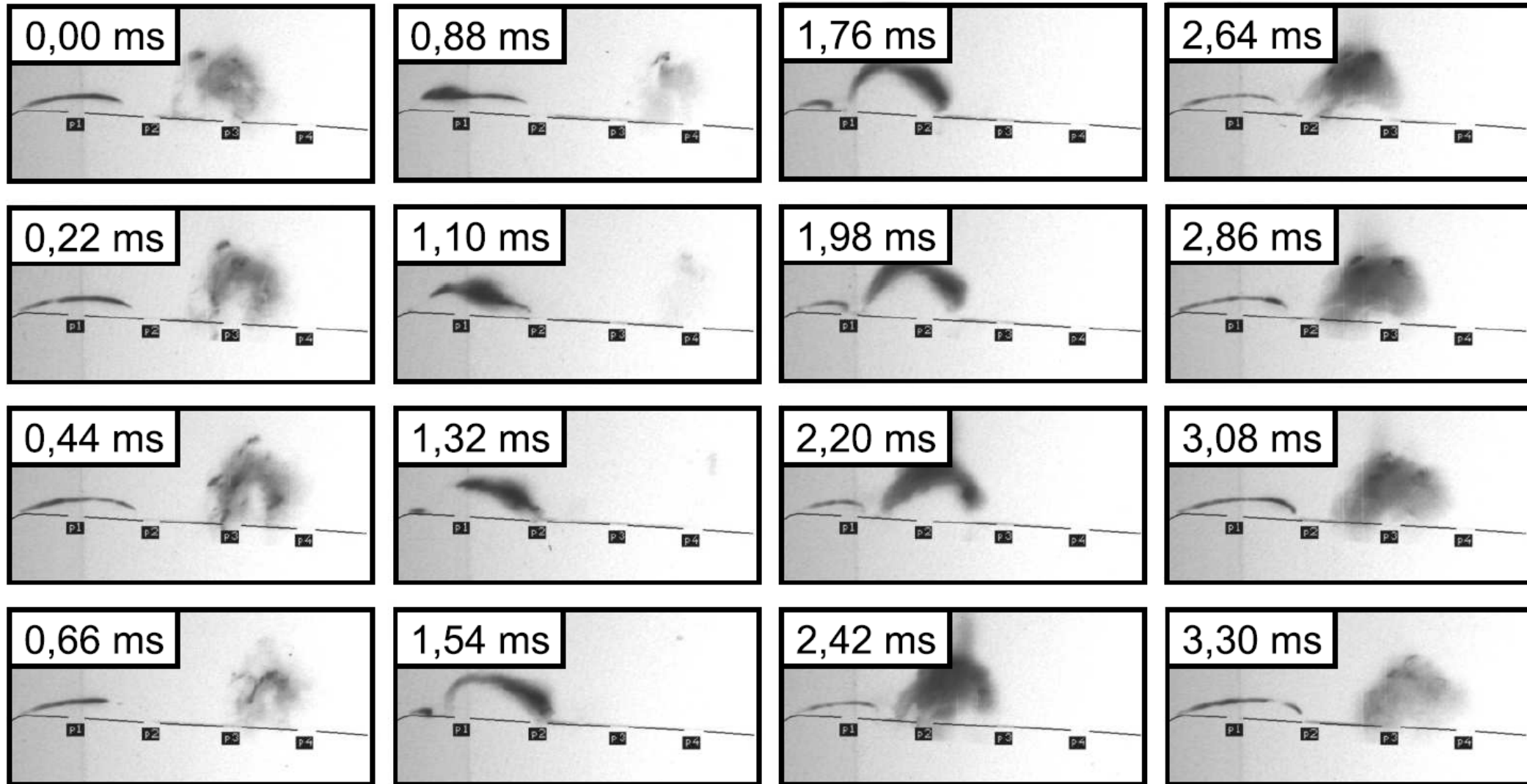
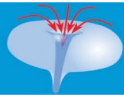

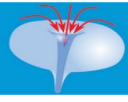

TUD IN UL (2002)

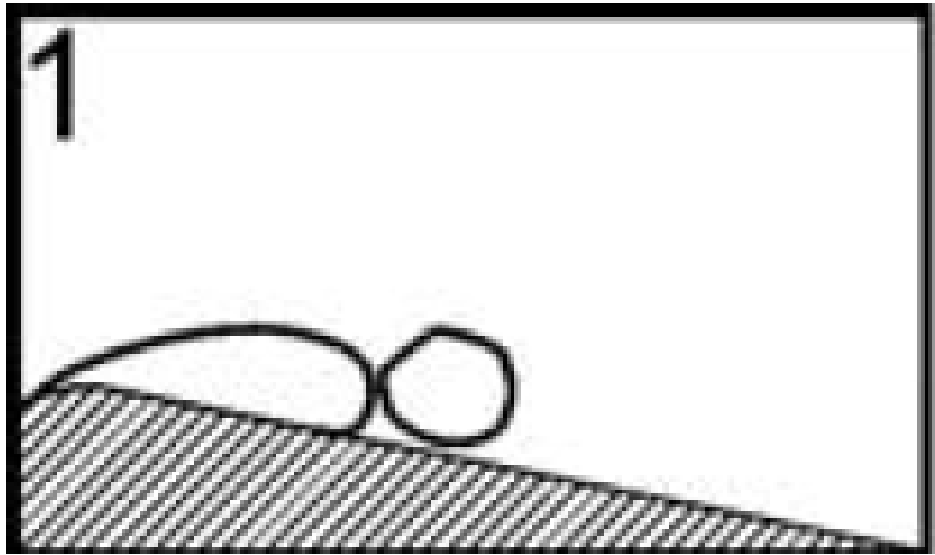
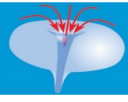

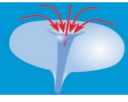

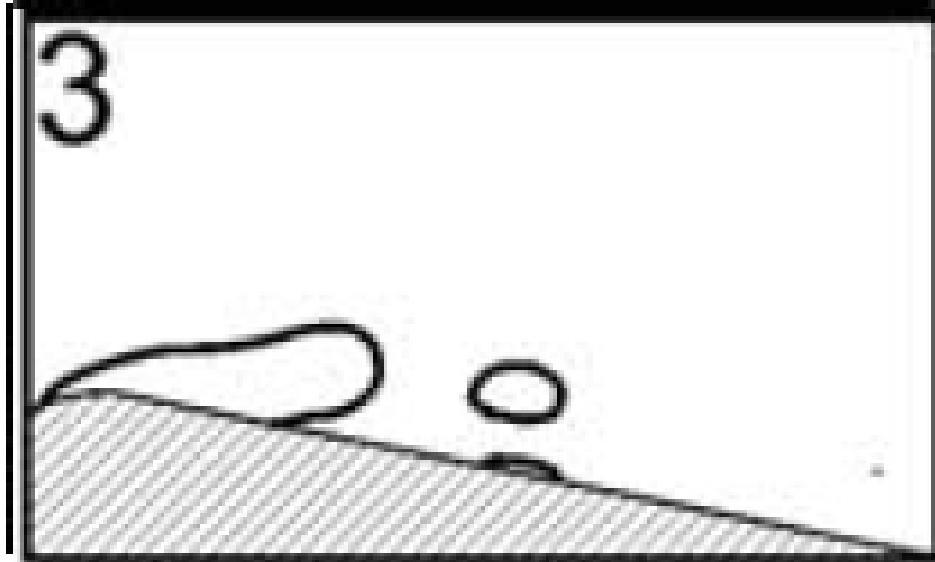
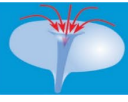

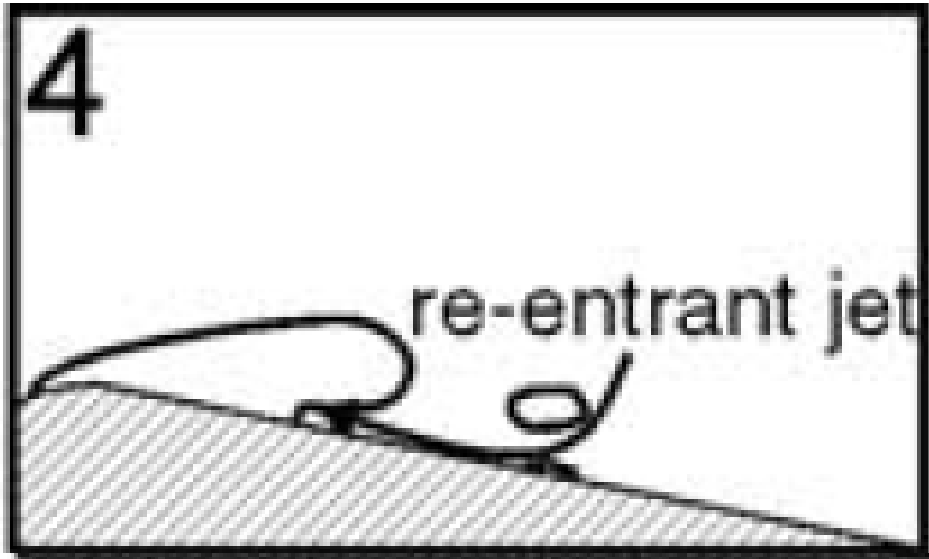
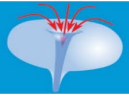

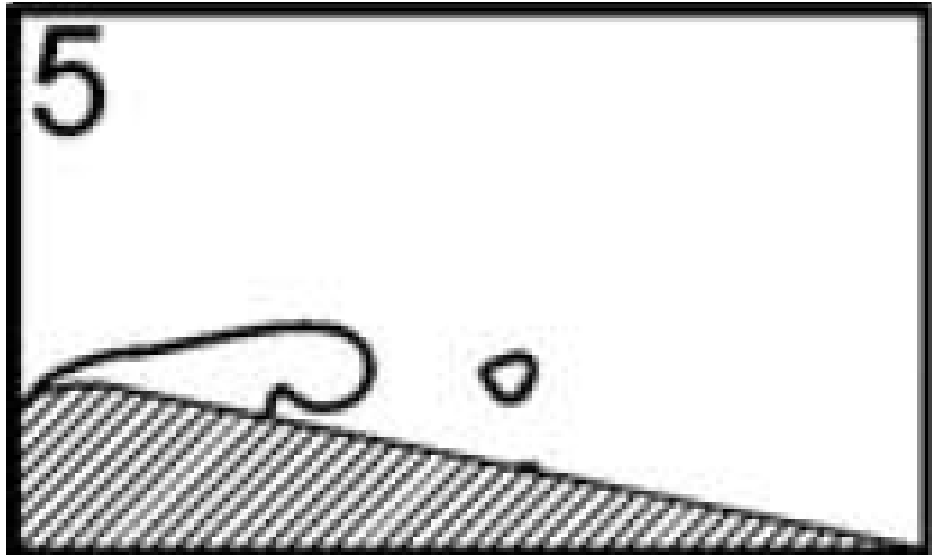
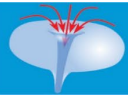

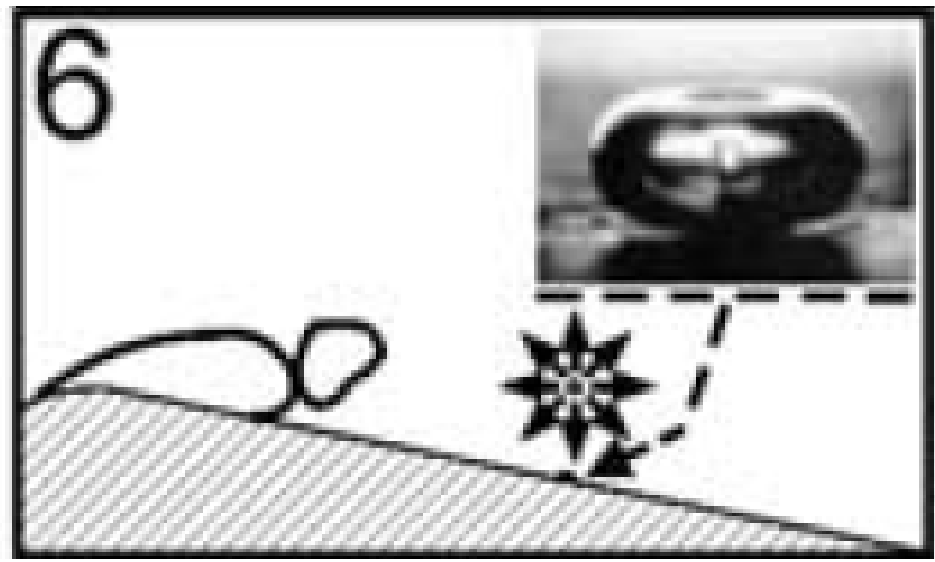
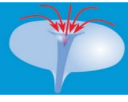

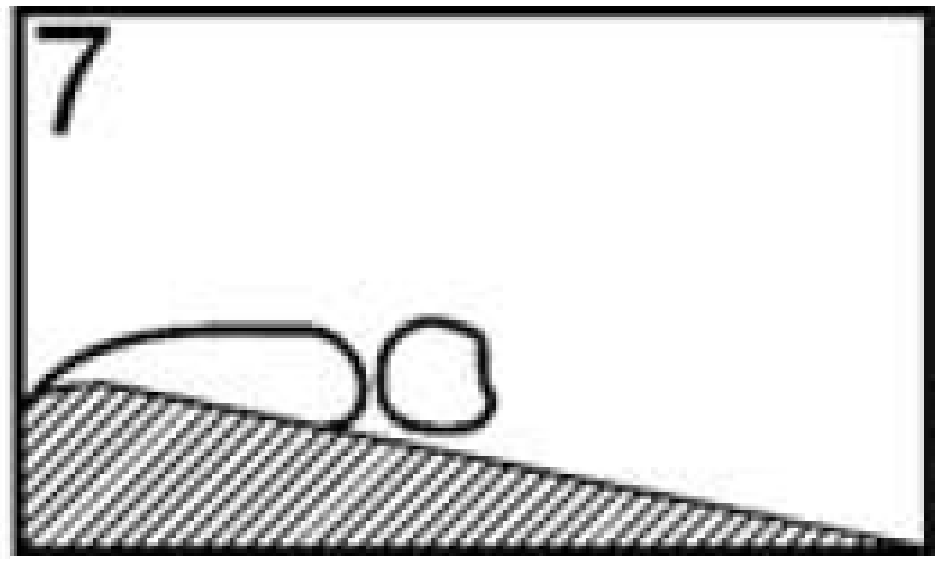
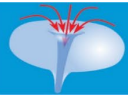

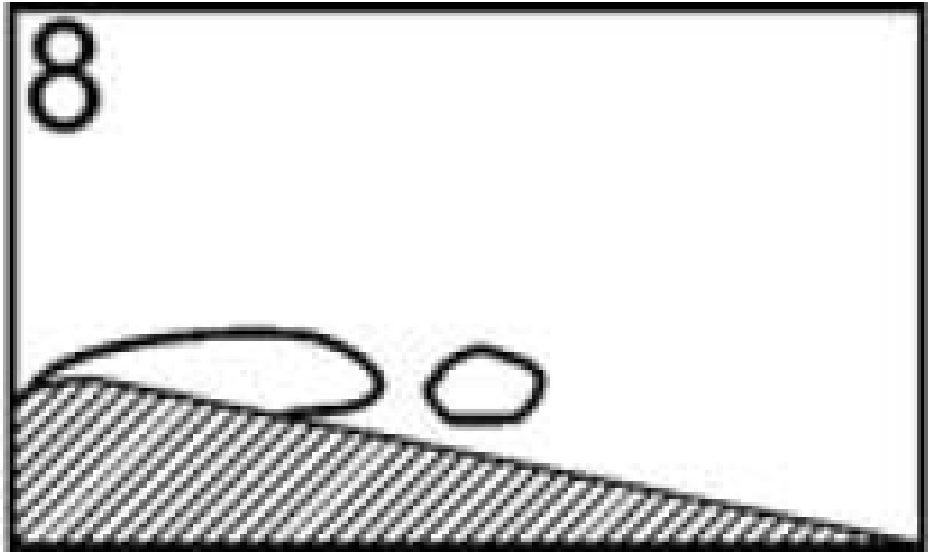
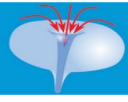

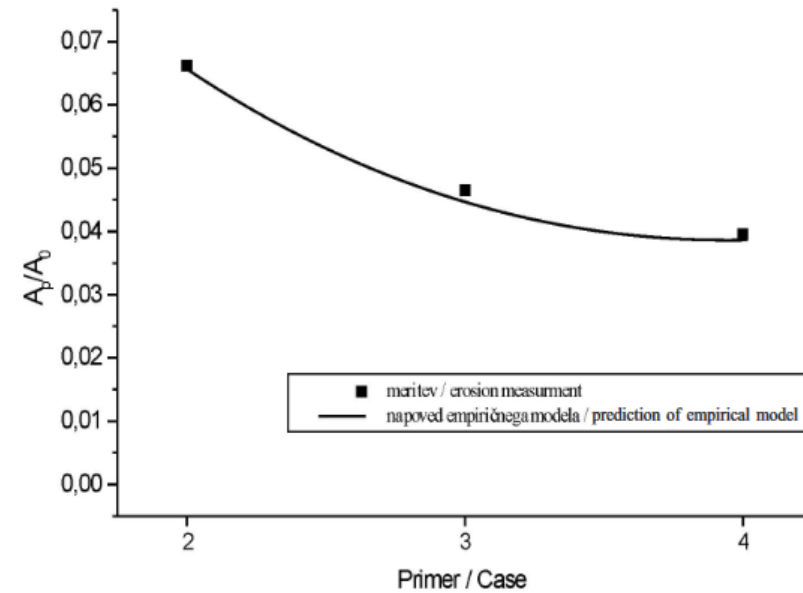
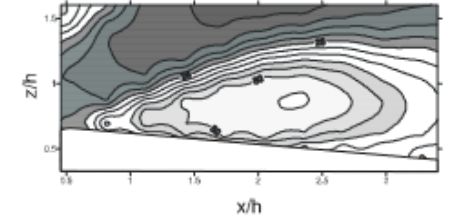
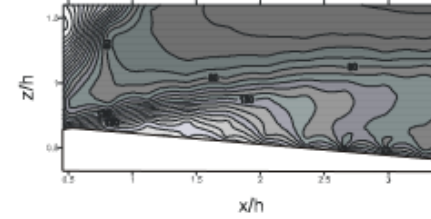
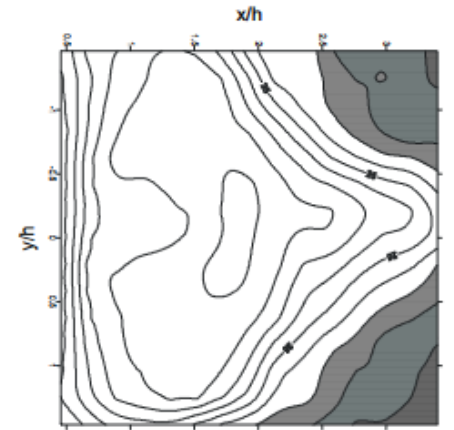
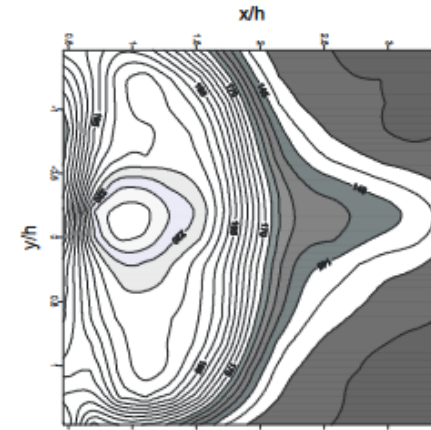
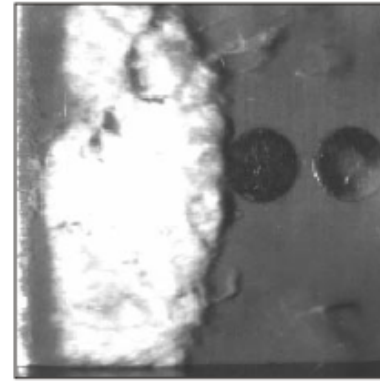
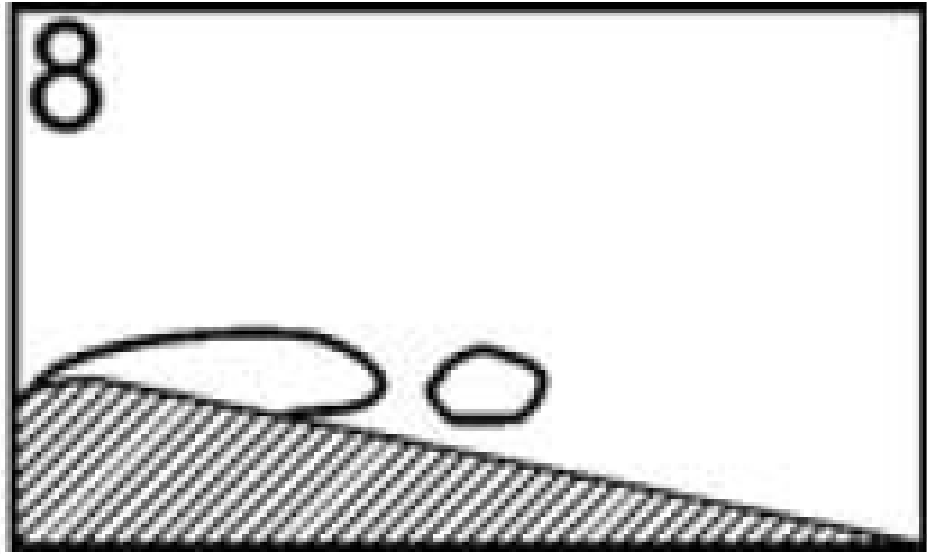
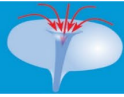

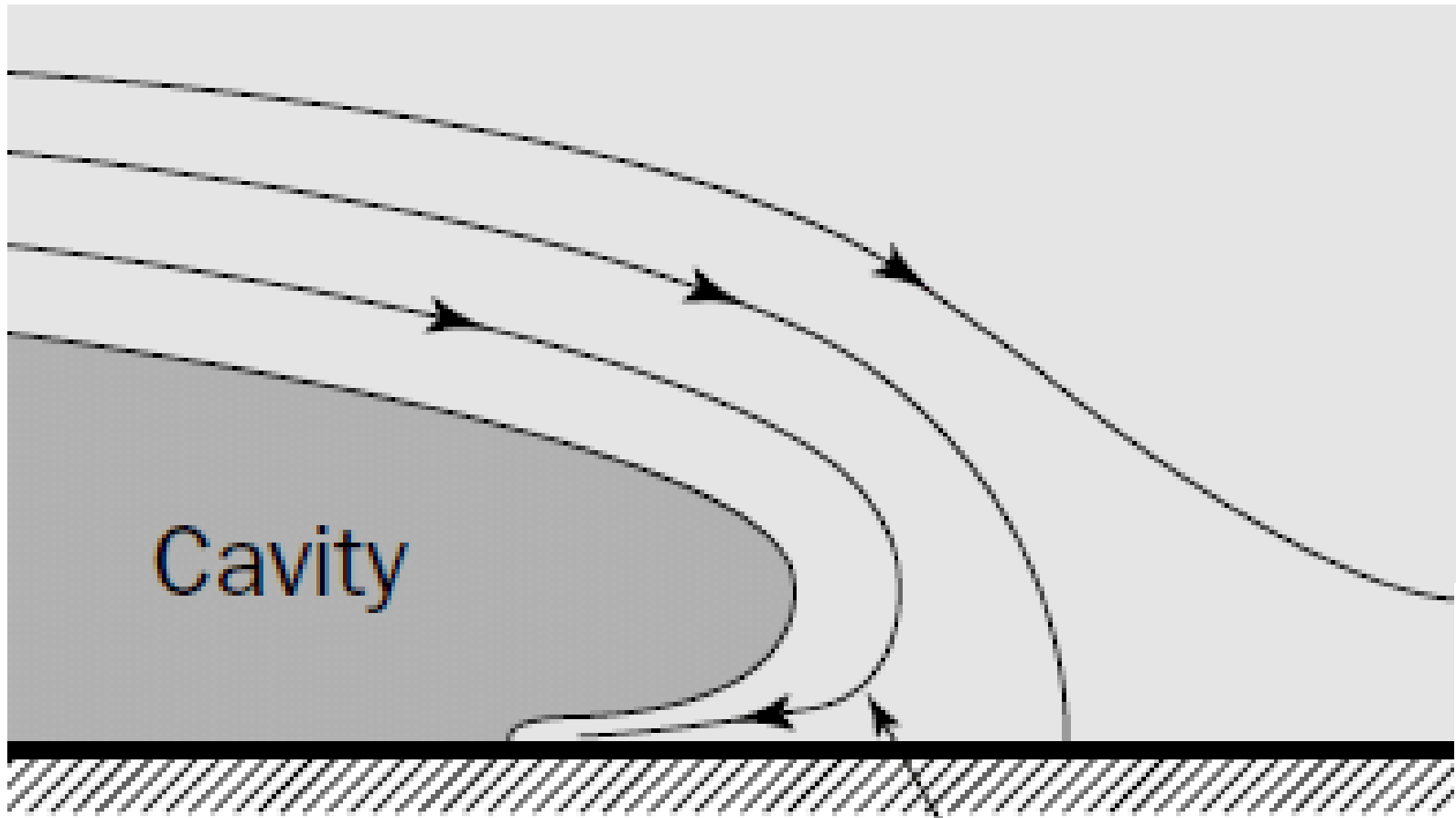
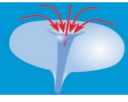

Cavity

Re-entrant jet

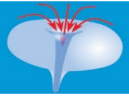

Flow



(a)

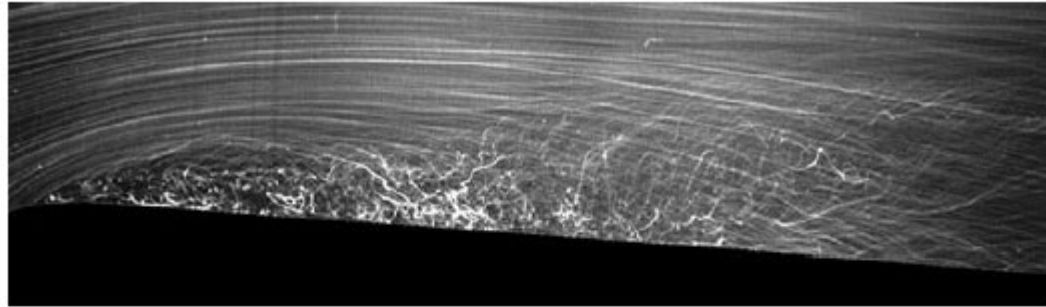

(b)

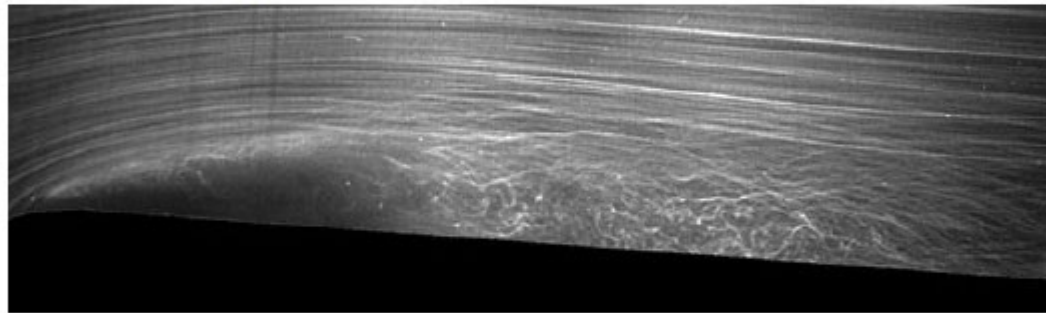

(c)

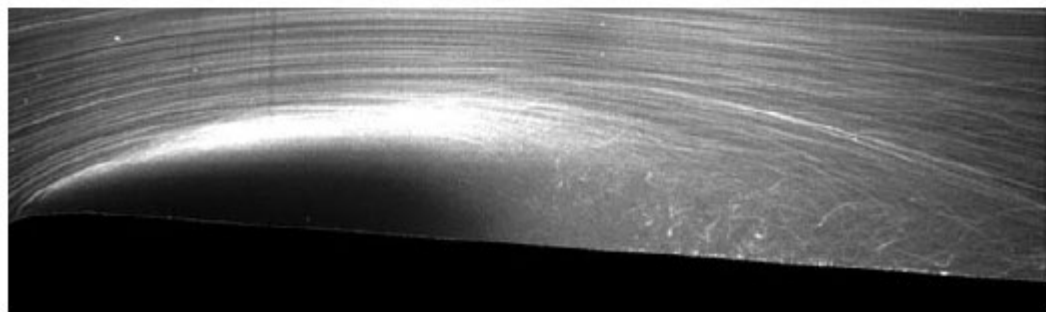

LABERTEAUX & CECCIO, **Partial cavity flows. Part 1. Cavities forming on models without spanwise variation**, J. Fluid Mech., vol. 431, pp. 1-41 (2001)

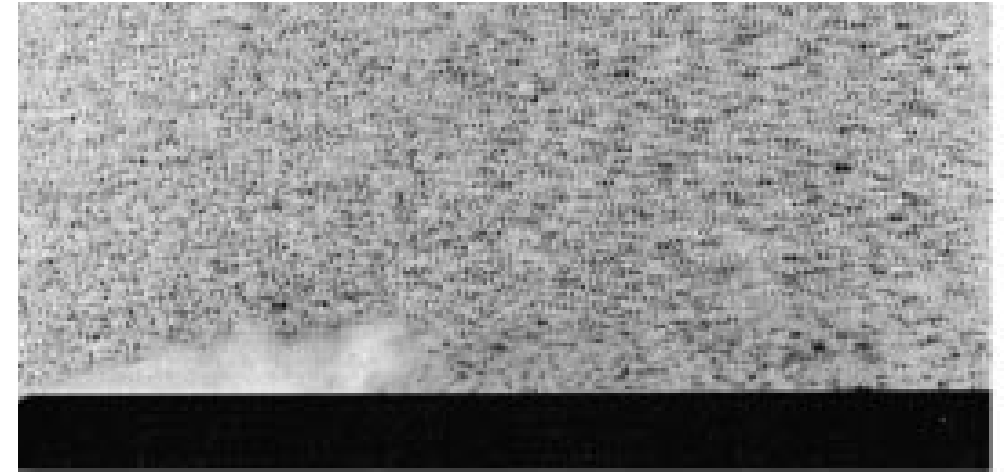
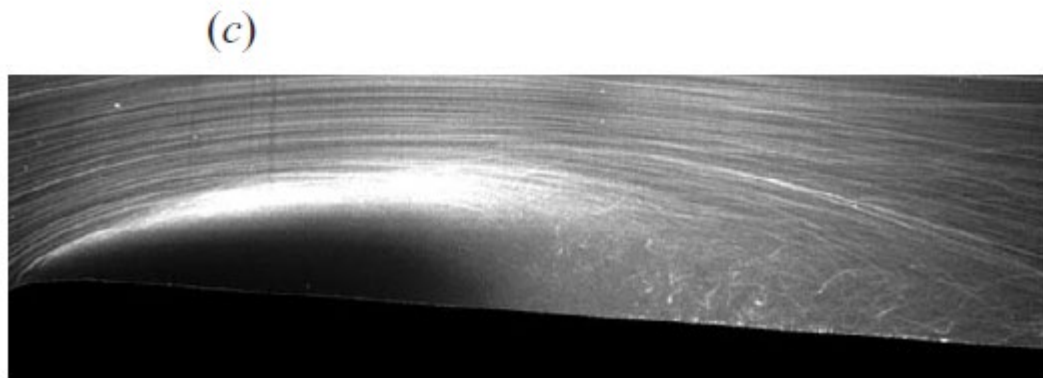
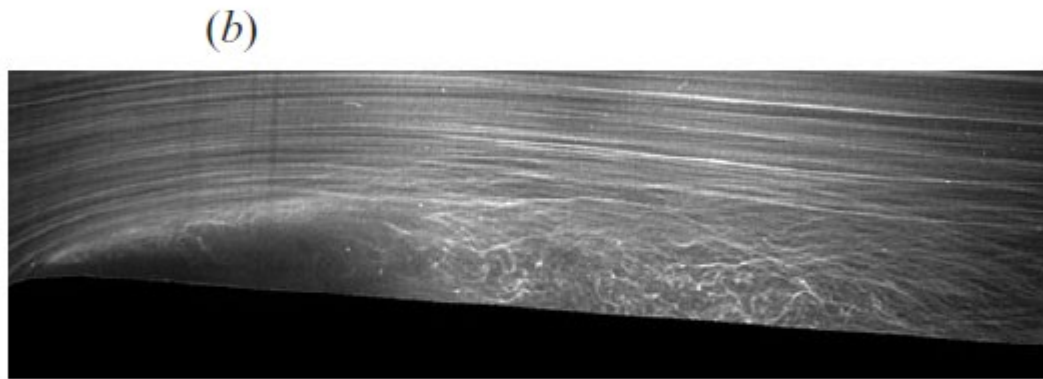
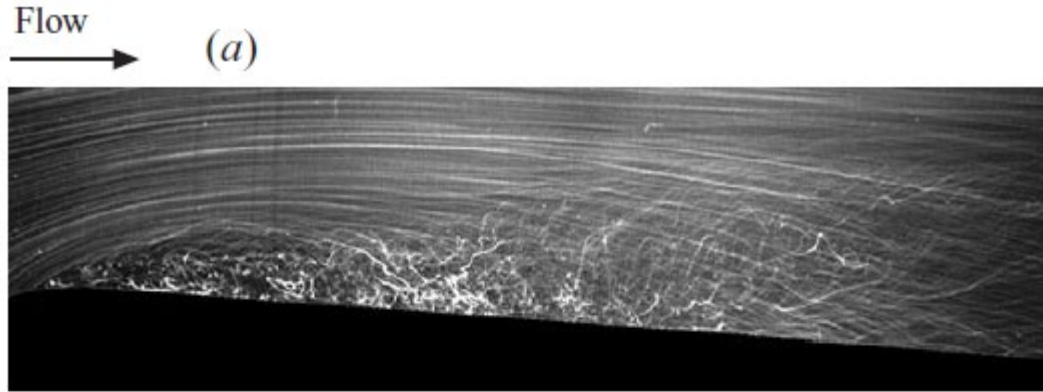

LABERTEAUX & CECCIO, **Partial cavity flows. Part 1. Cavities forming on models without spanwise variation**, J. Fluid Mech., vol. 431, pp. 1-41 (2001)

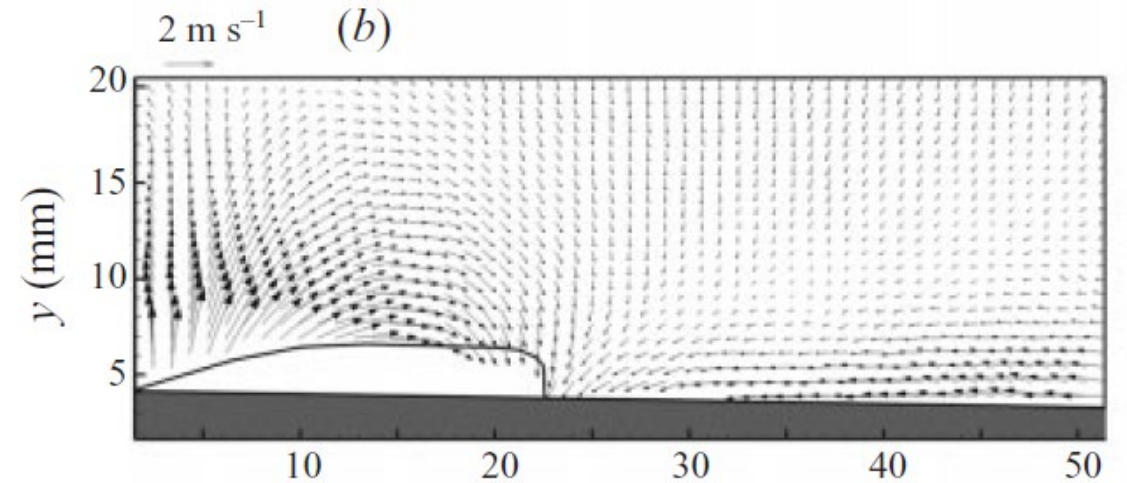
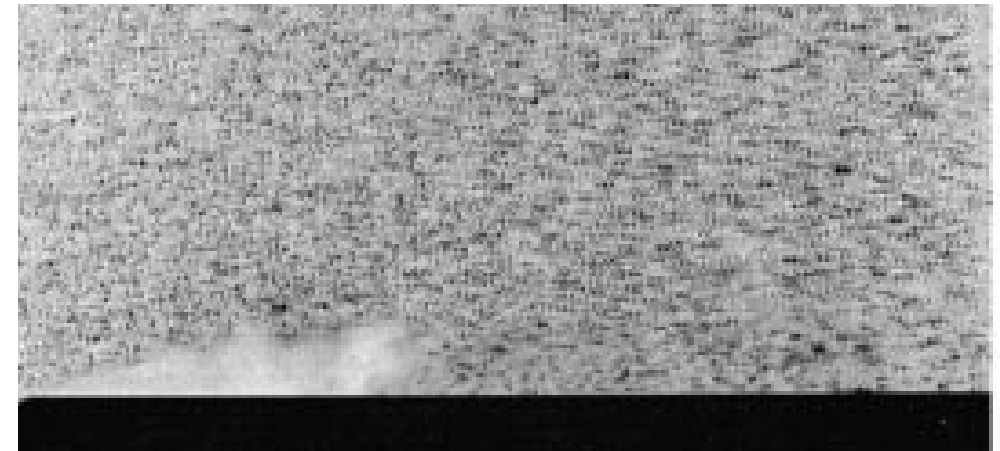
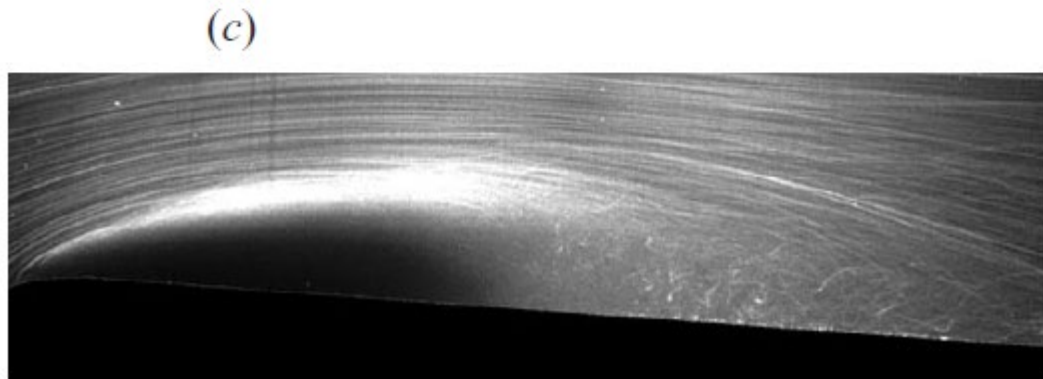
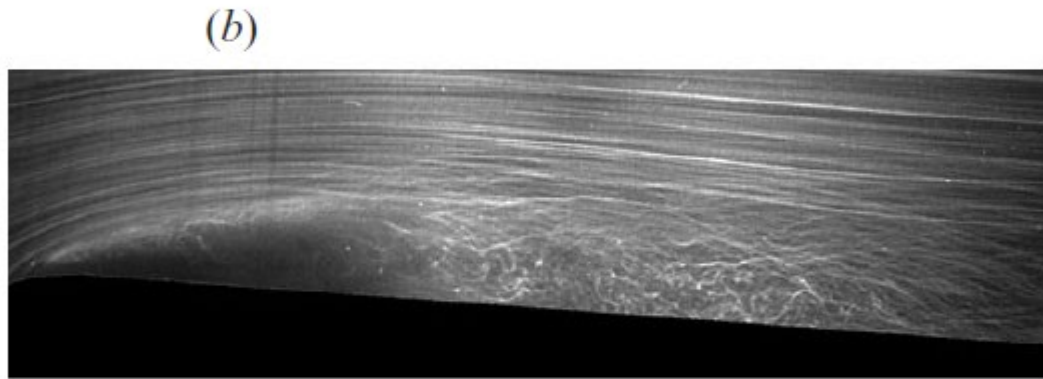
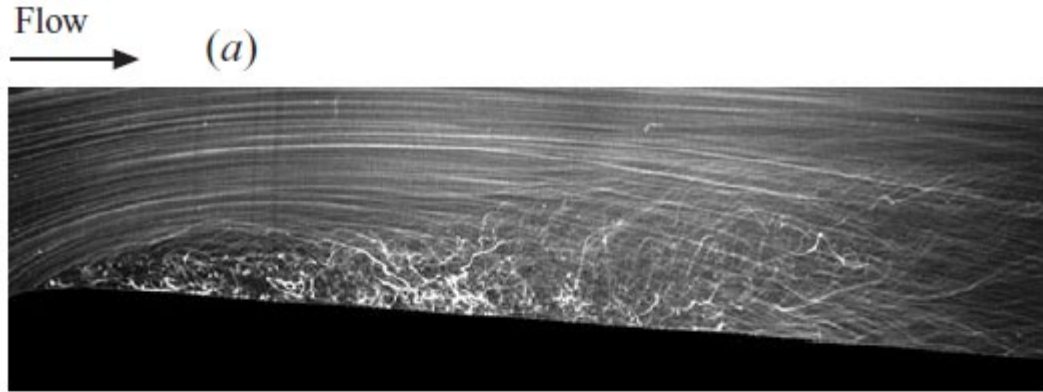

LABERTEAUX & CECCIO, **Partial cavity flows. Part 1. Cavities forming on models without spanwise variation**, J. Fluid Mech., vol. 431, pp. 1-41 (2001)

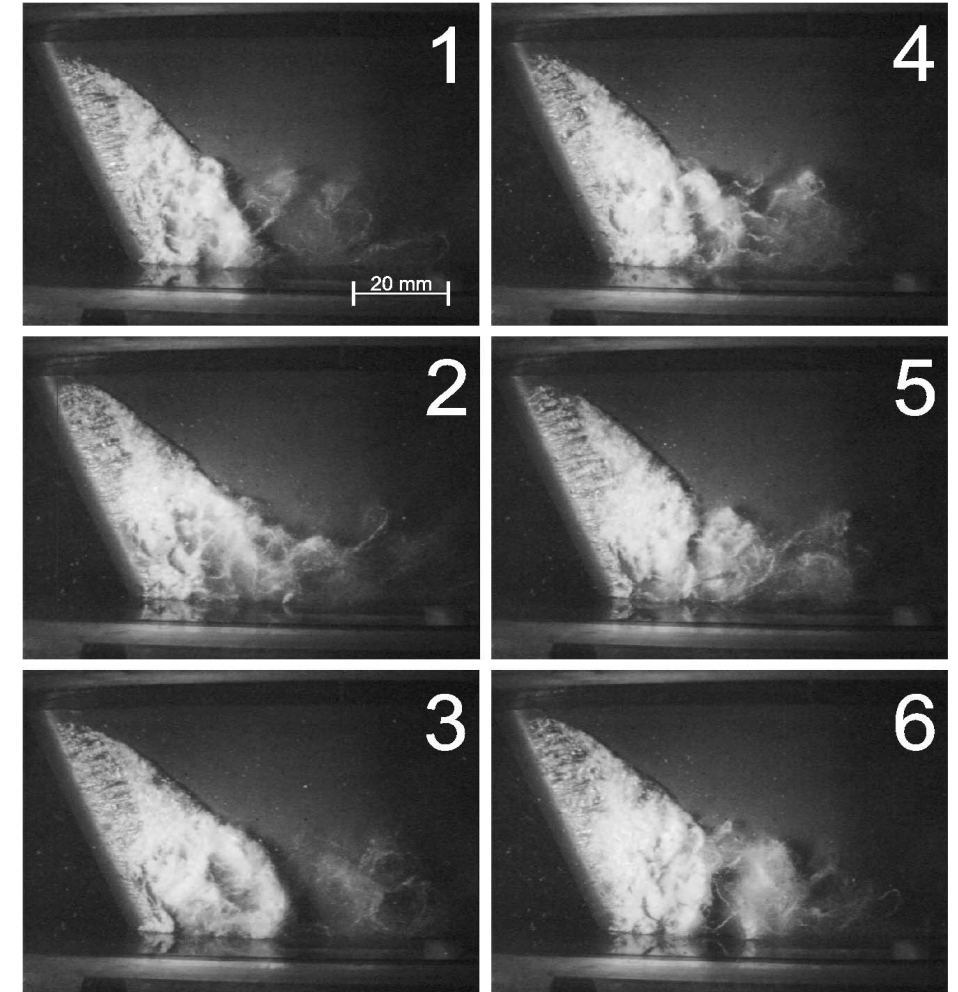
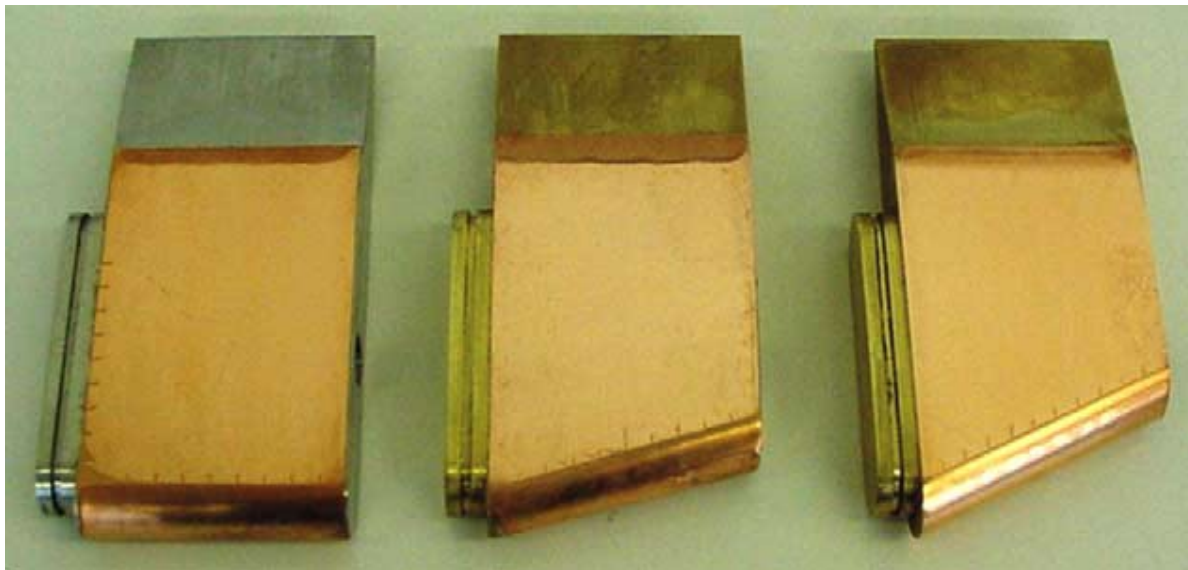
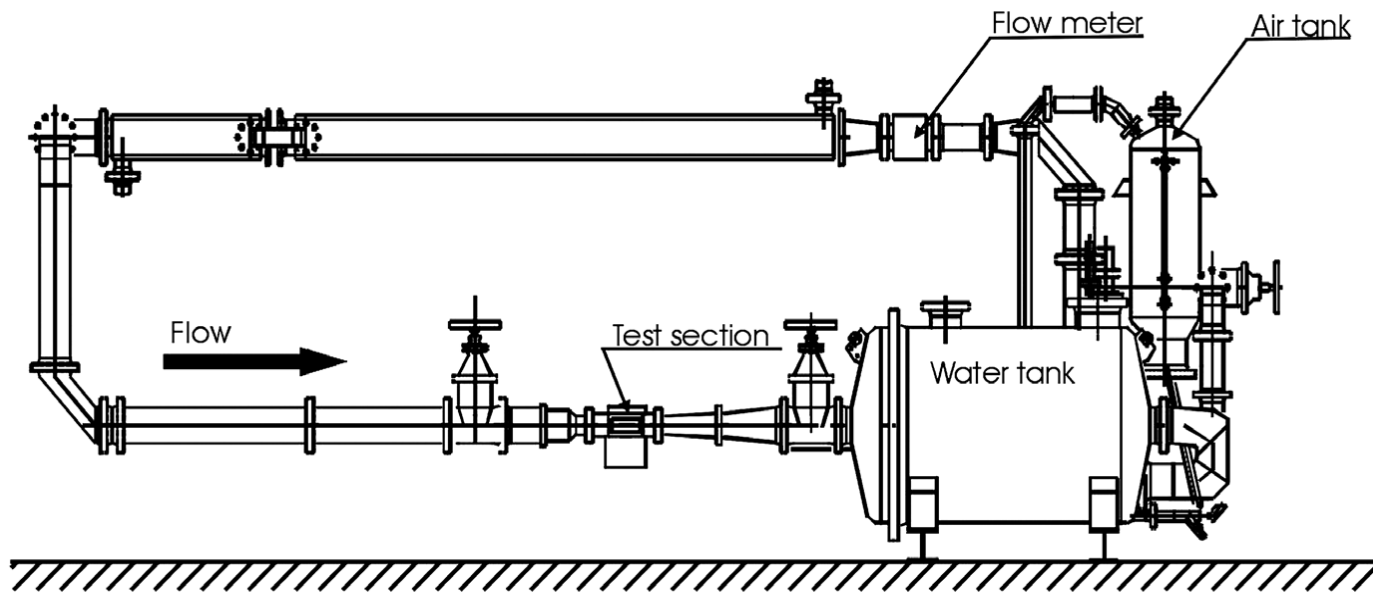

DULAR, Matevž, BACHERT, Rudolf, STOFFEL, Bernd, ŠIROK, Brane. **Experimental evaluation of numerical simulation of cavitating flow around hydrofoil.** *Eur. j. mech. B, Fluids*, vol. 24, iss. 4, pp. 522-538, 2005

Flow Map 1501

Acquisition & Control Unit



Nd-YAG Laser

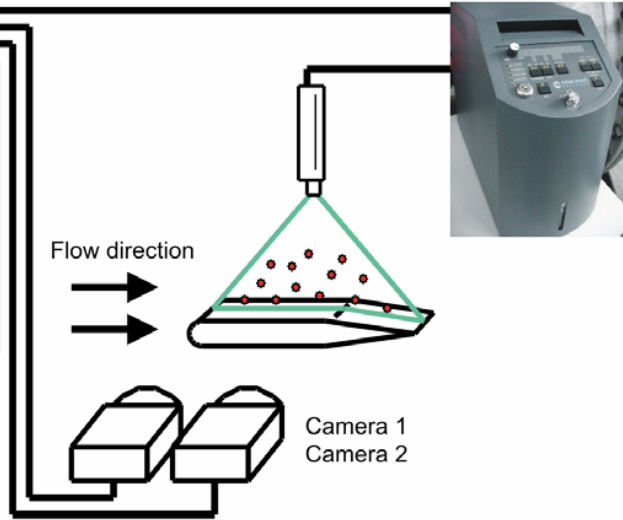

DULAR, Matevž, BACHERT, Rudolf, STOFFEL, Bernd, ŠIROK, Brane. **Experimental evaluation of numerical simulation of cavitating flow around hydrofoil.** *Eur. j. mech. B, Fluids*, vol. 24, iss. 4, pp. 522-538, 2005

Flow Map 1501

Acquisition & Control Unit

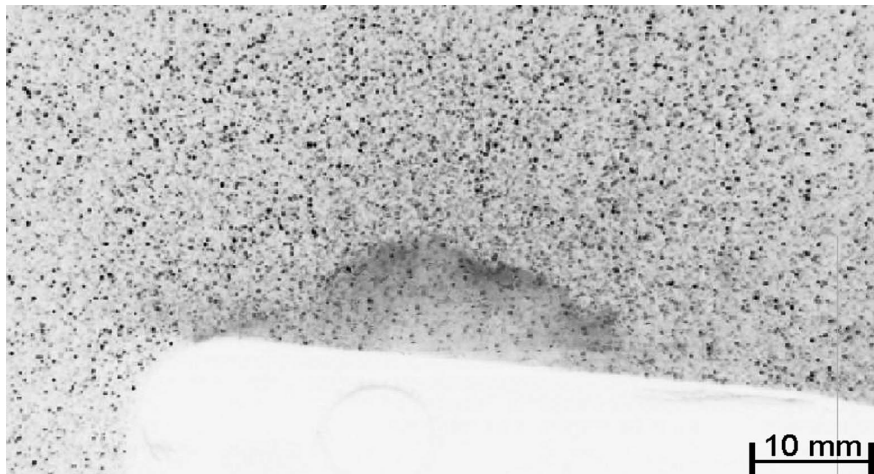
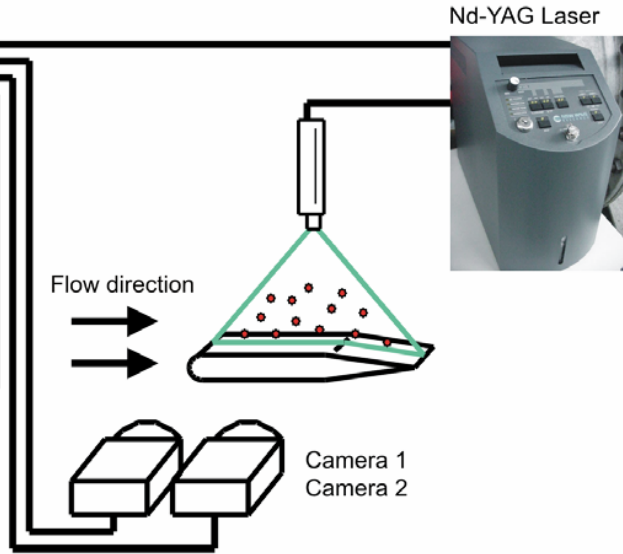

DULAR, Matevž, BACHERT, Rudolf, STOFFEL, Bernd, ŠIROK, Brane. **Experimental evaluation of numerical simulation of cavitating flow around hydrofoil.** *Eur. j. mech. B, Fluids*, vol. 24, iss. 4, pp. 522-538, 2005

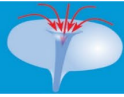

Flow Map 1501

Acquisition & Control Unit



Nd-YAG Laser



Flow direction
→

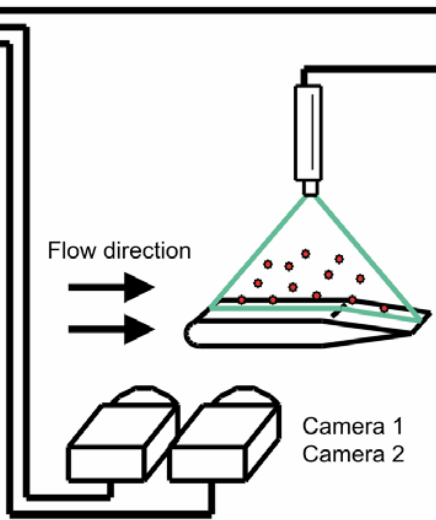

Camera 1
Camera 2

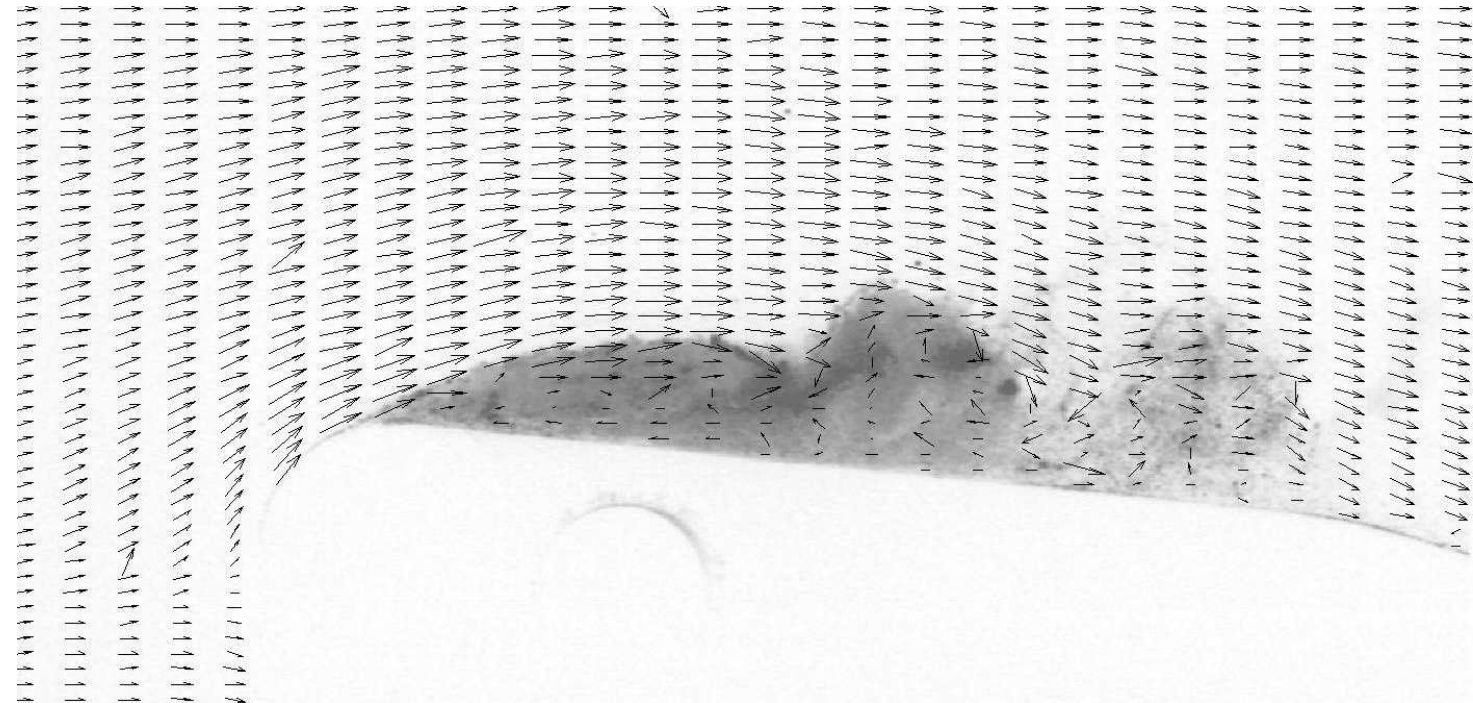
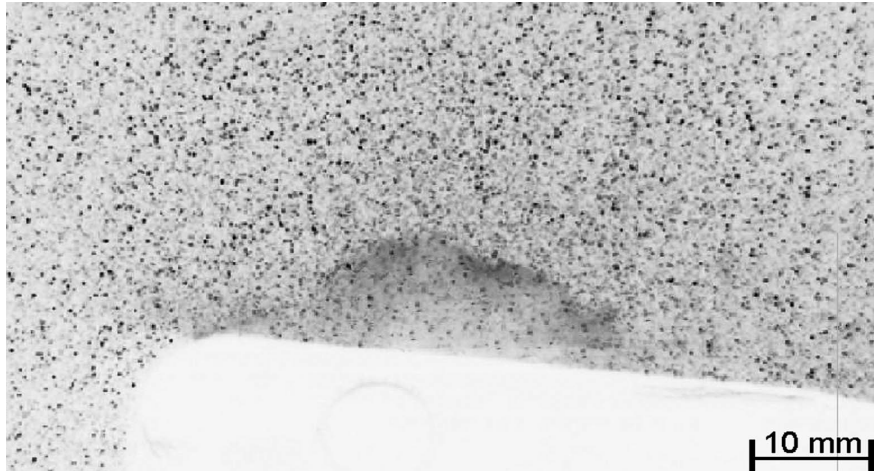

DULAR, Matevž, BACHERT, Rudolf, STOFFEL, Bernd, ŠIROK, Brane. **Experimental evaluation of numerical simulation of cavitating flow around hydrofoil.** *Eur. j. mech. B, Fluids*, vol. 24, iss. 4, pp. 522-538, 2005

Flow Map 1501

Acquisition & Control Unit

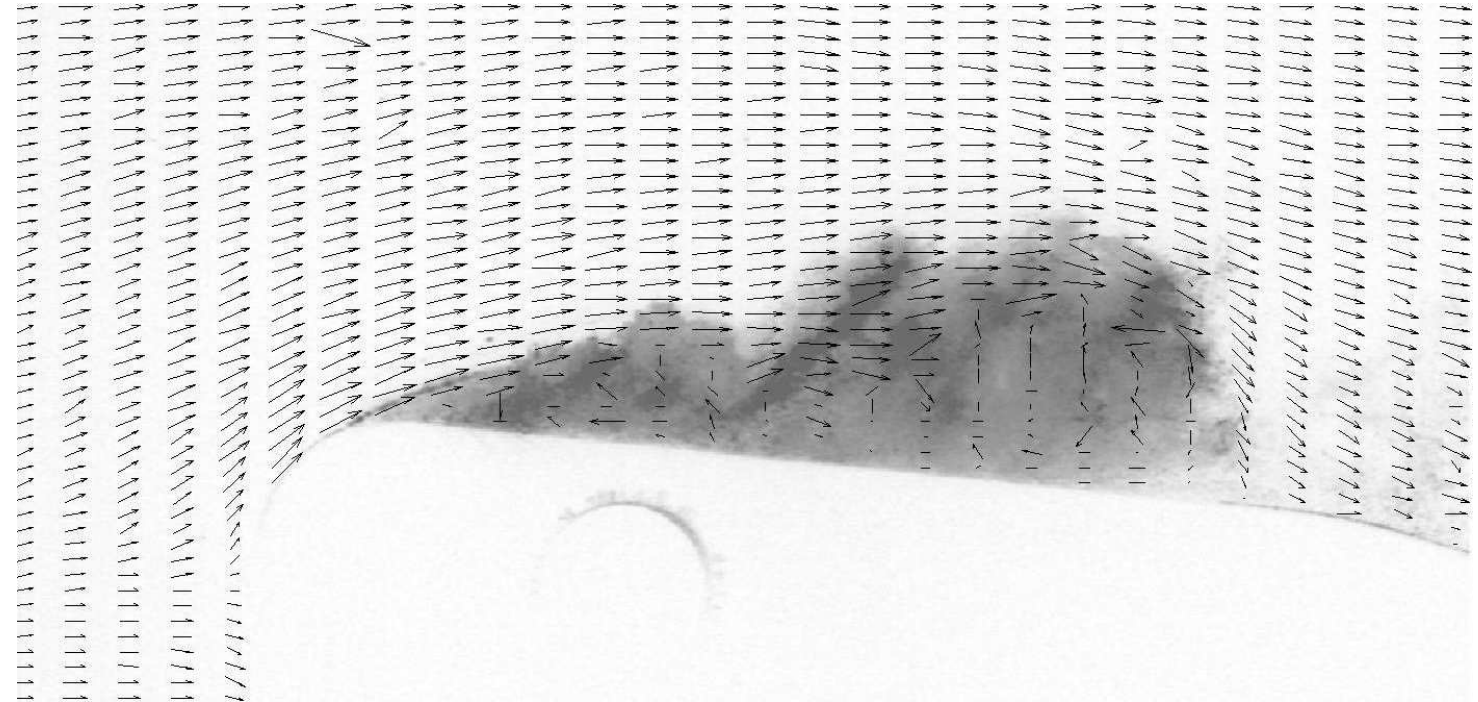
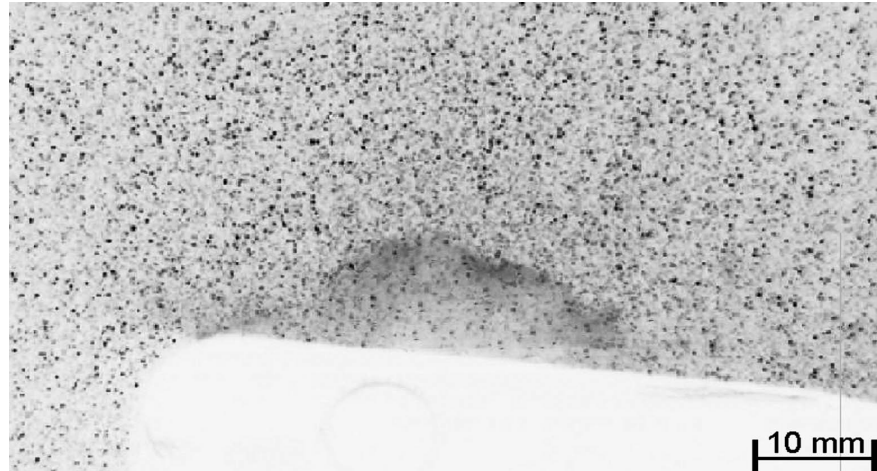
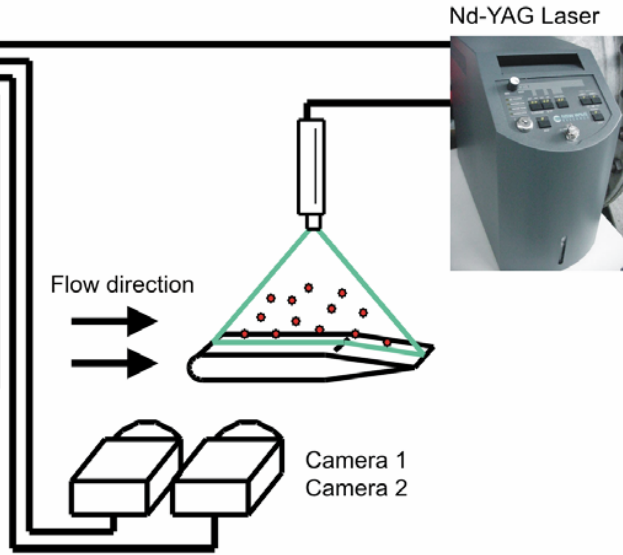

DULAR, Matevž, BACHERT, Rudolf, STOFFEL, Bernd, ŠIROK, Brane. **Experimental evaluation of numerical simulation of cavitating flow around hydrofoil.** *Eur. j. mech. B, Fluids*, vol. 24, iss. 4, pp. 522-538, 2005

Flow Map 1501

Acquisition & Control Unit

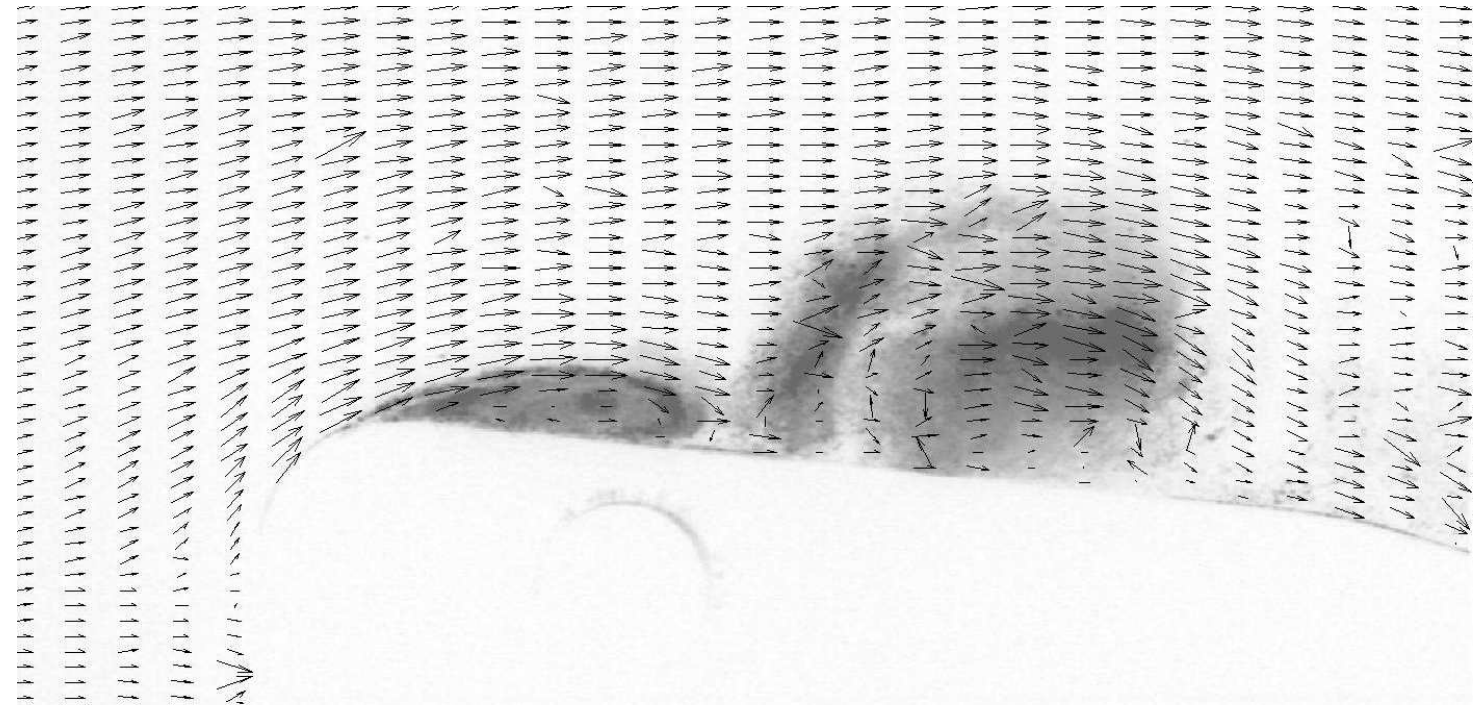
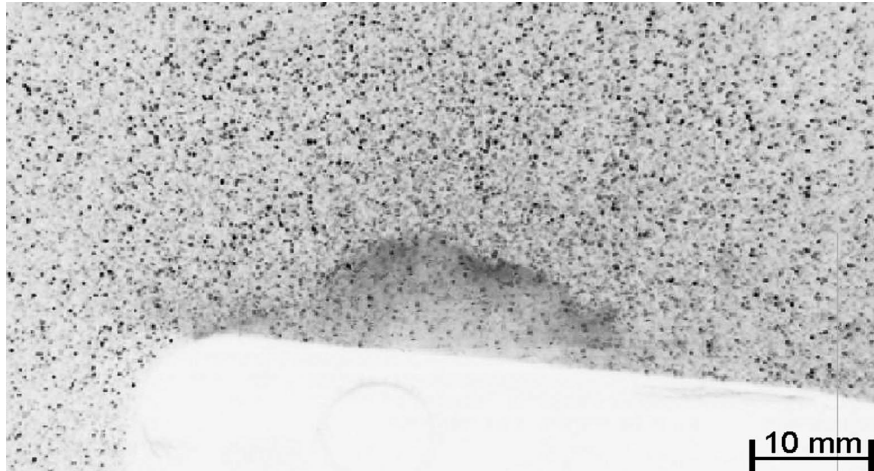
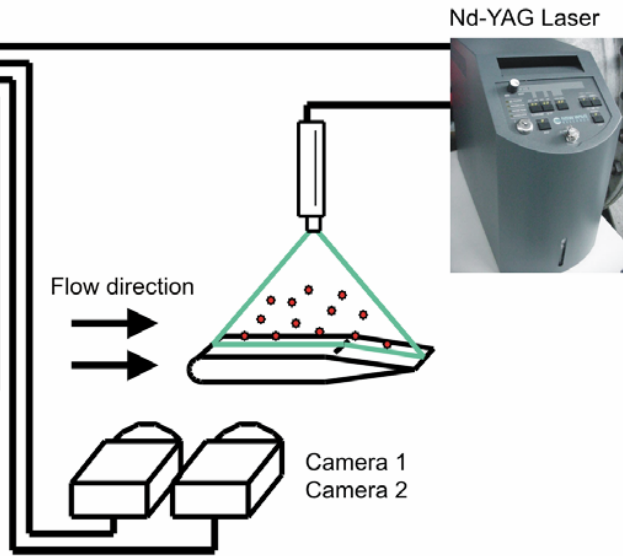

DULAR, Matevž, BACHERT, Rudolf, STOFFEL, Bernd, ŠIROK, Brane. **Experimental evaluation of numerical simulation of cavitating flow around hydrofoil.** *Eur. j. mech. B, Fluids*, vol. 24, iss. 4, pp. 522-538, 2005



Flow Map 1501

Acquisition & Control Unit



Nd-YAG Laser



Flow direction

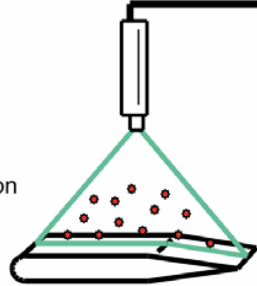
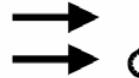

Camera 1
Camera 2

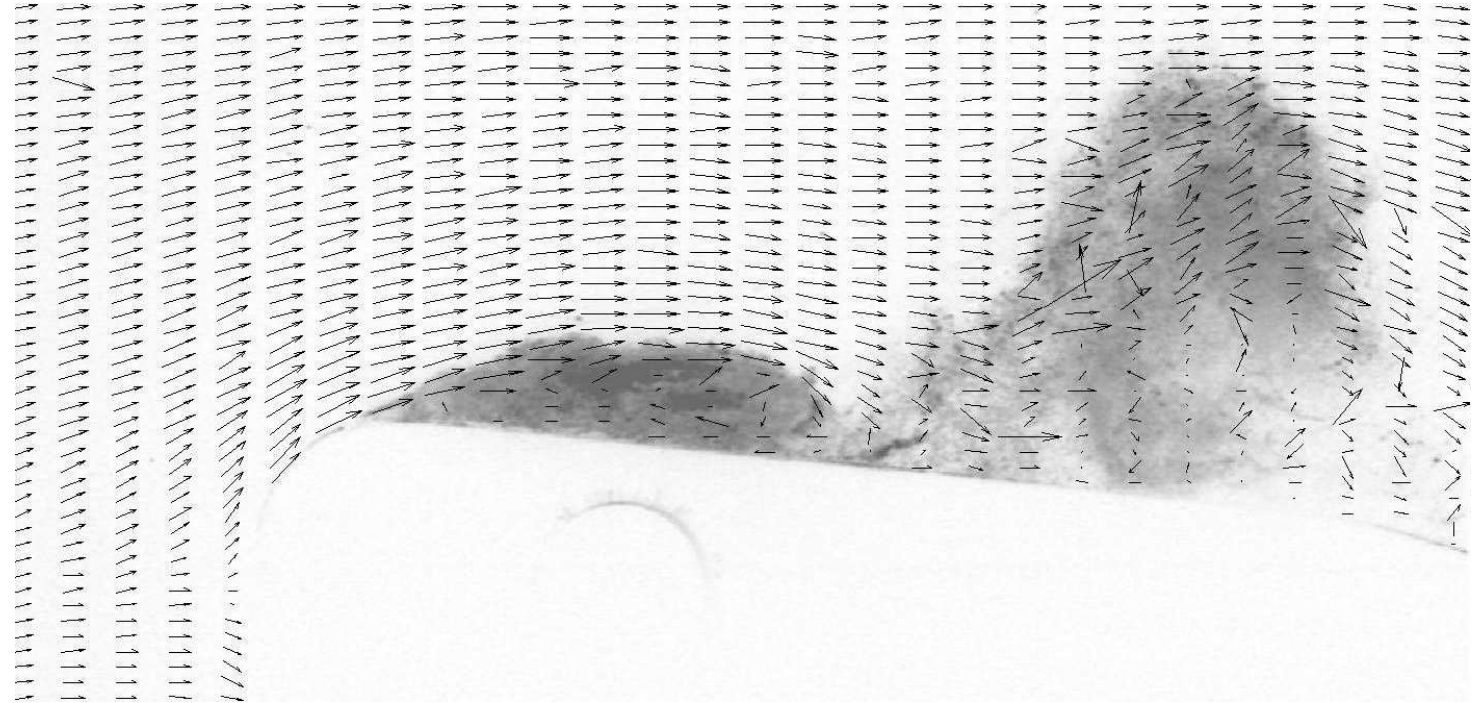
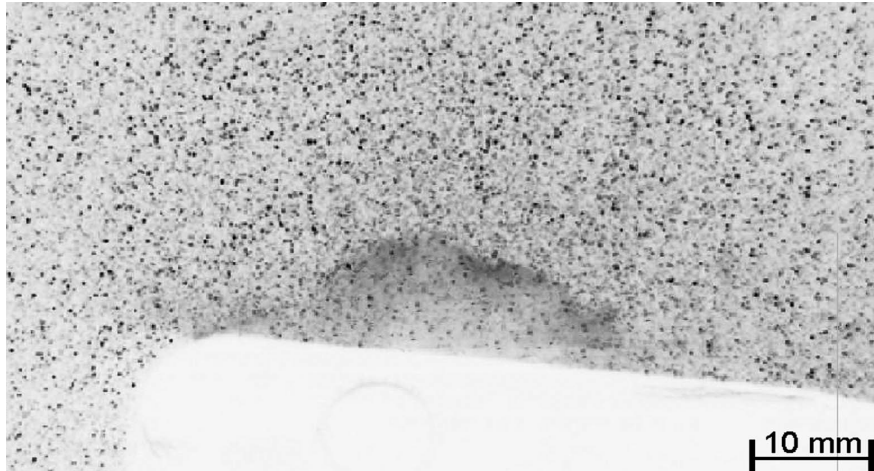

DULAR, Matevž, BACHERT, Rudolf, STOFFEL, Bernd, ŠIROK, Brane. **Experimental evaluation of numerical simulation of cavitating flow around hydrofoil.** *Eur. j. mech. B, Fluids*, vol. 24, iss. 4, pp. 522-538, 2005

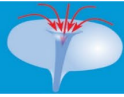

Flow Map 1501

Acquisition & Control Unit



Nd-YAG Laser



Flow direction
→ →

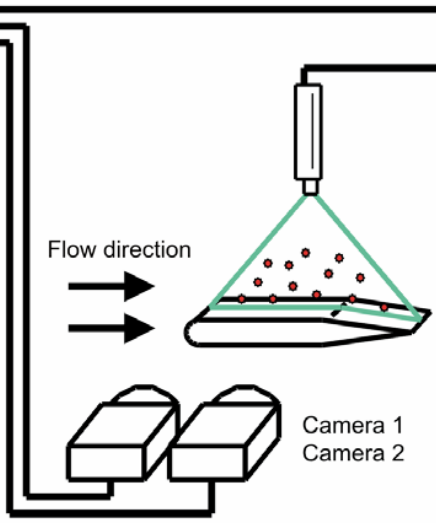

Camera 1
Camera 2

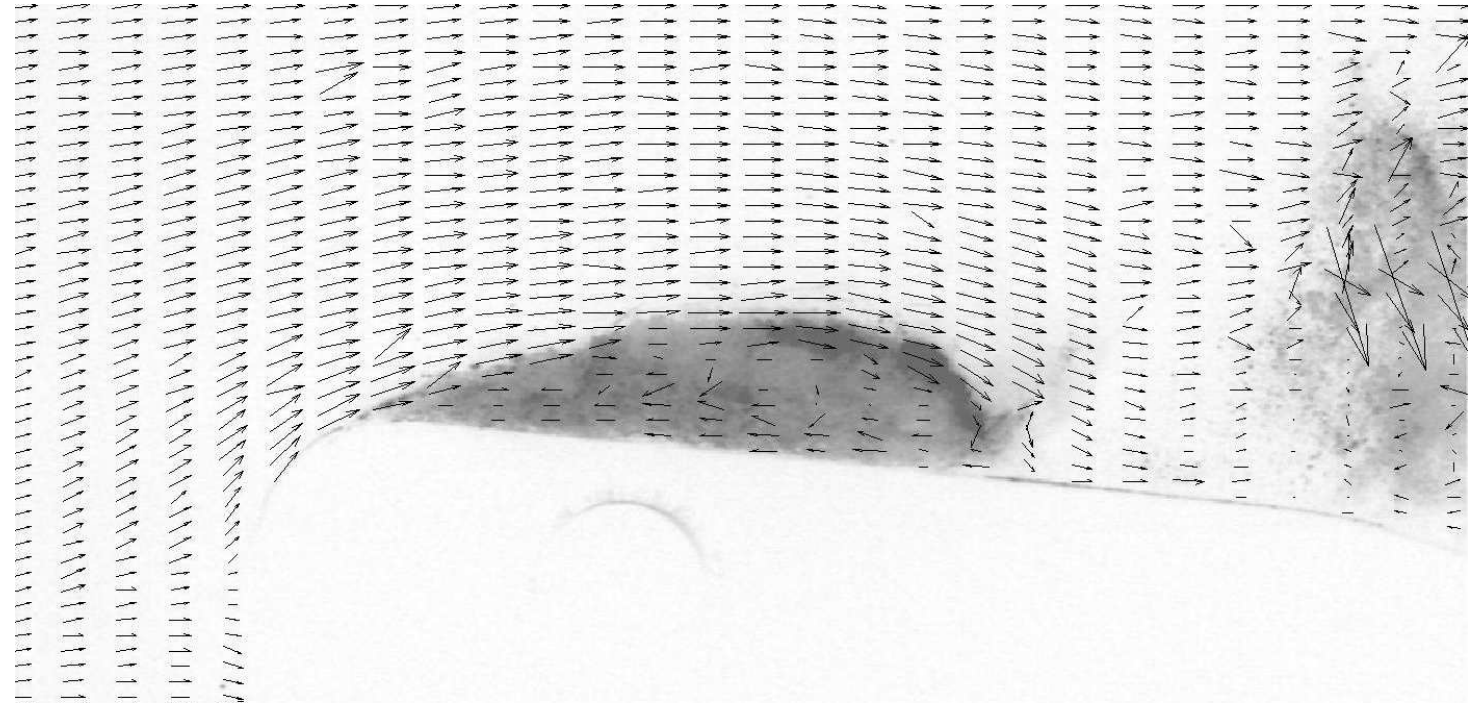
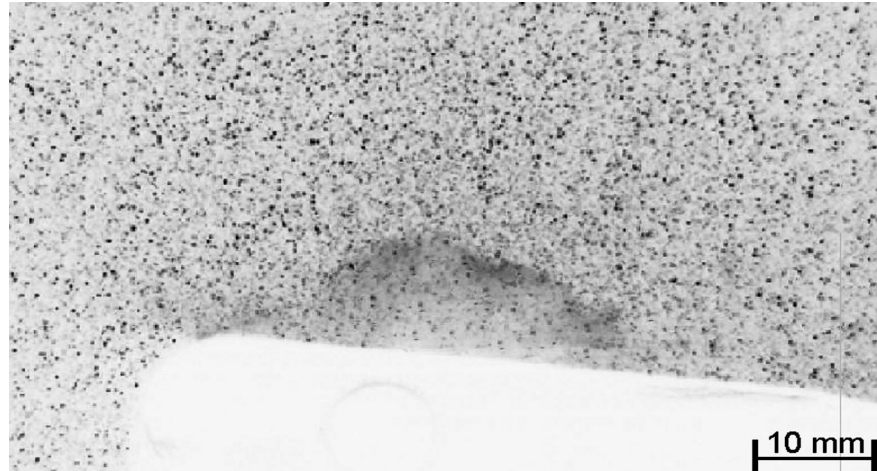

DULAR, Matevž, BACHERT, Rudolf, STOFFEL, Bernd, ŠIROK, Brane. **Experimental evaluation of numerical simulation of cavitating flow around hydrofoil.** *Eur. j. mech. B, Fluids*, vol. 24, iss. 4, pp. 522-538, 2005

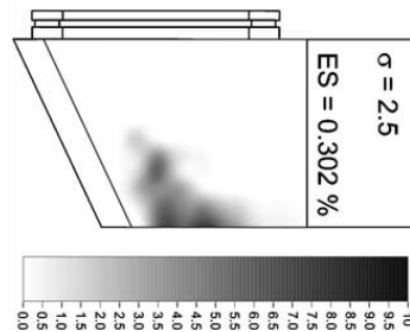
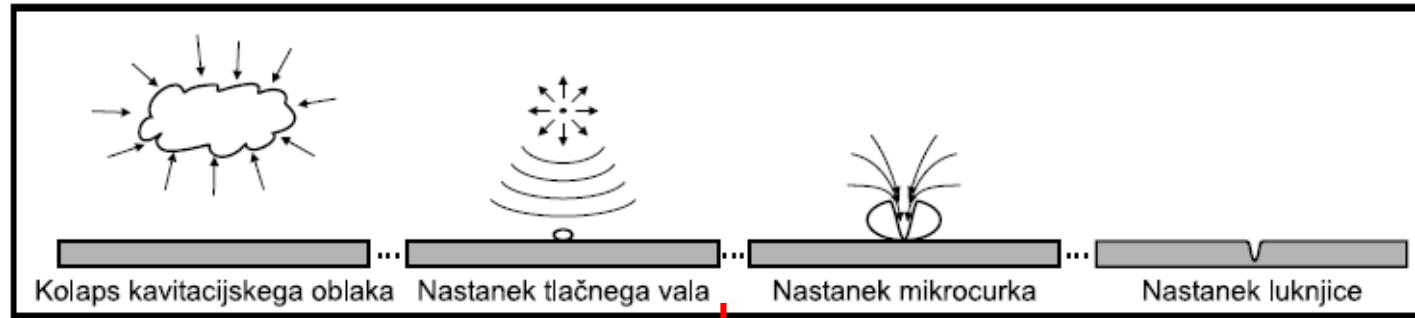
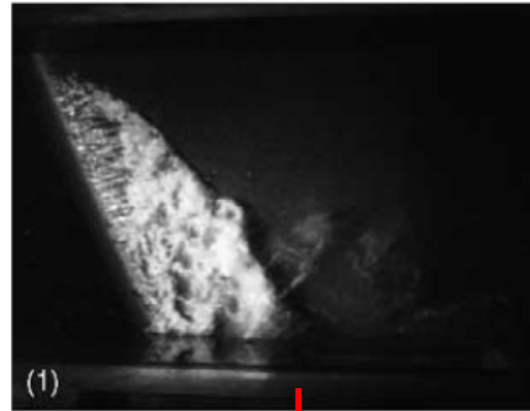
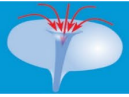

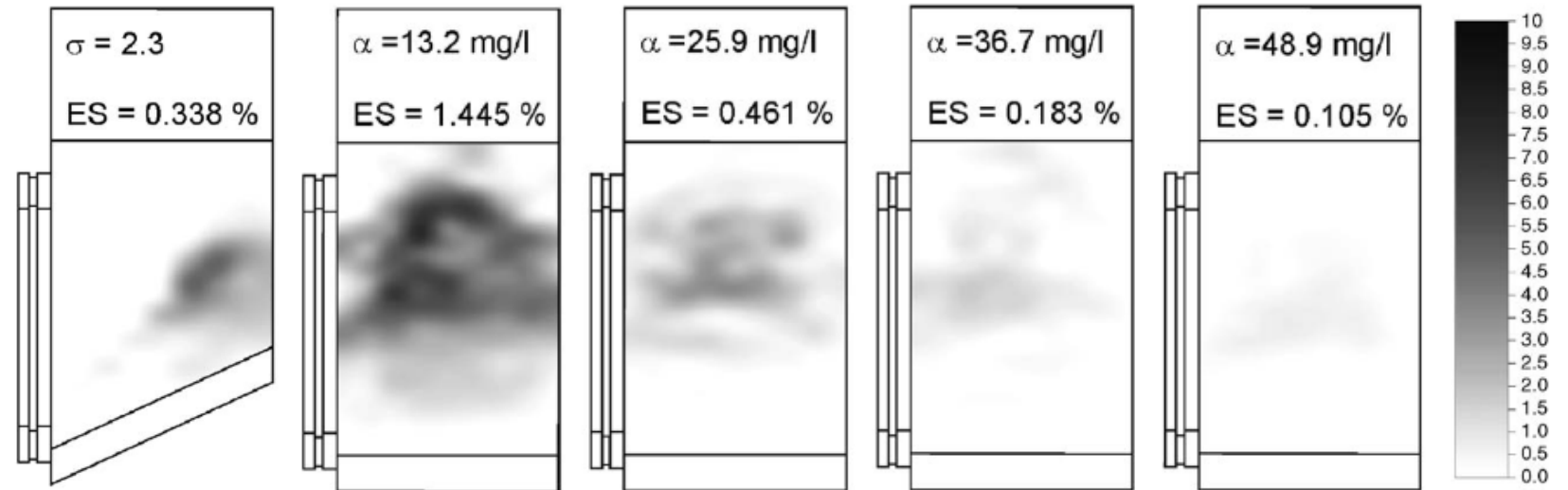
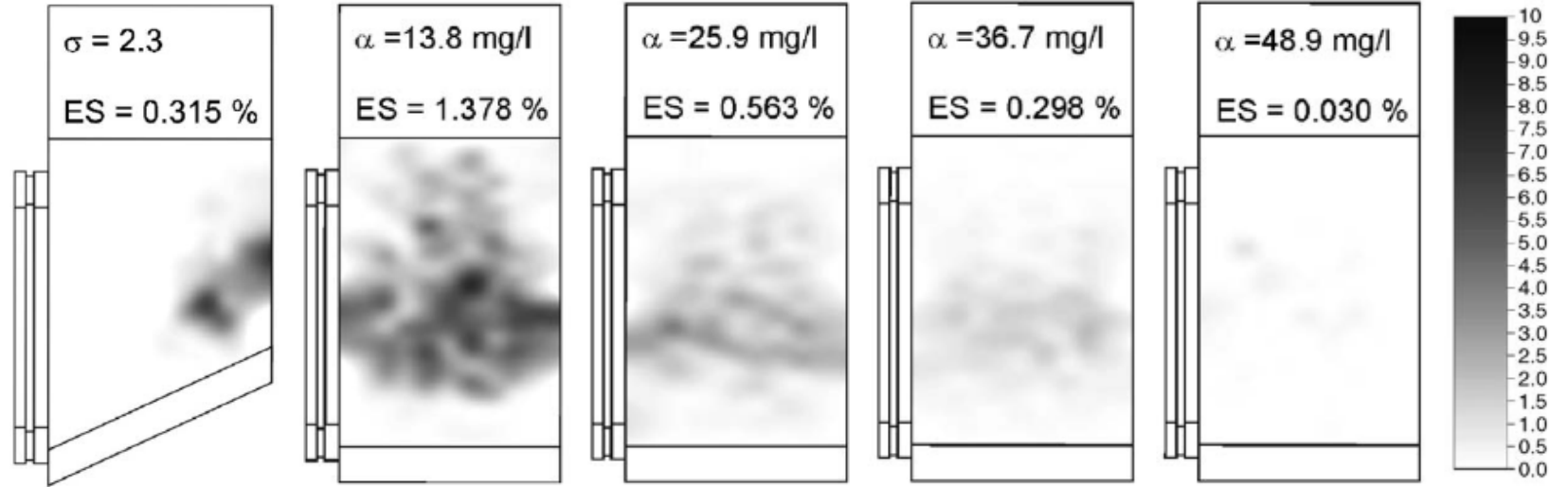

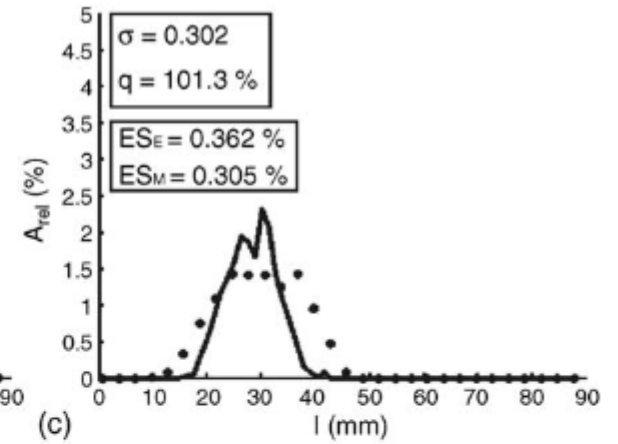
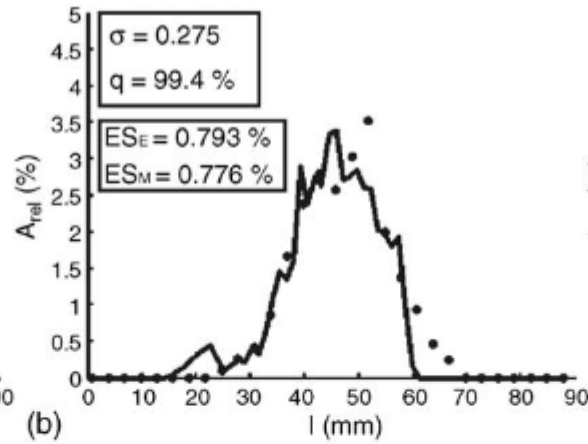
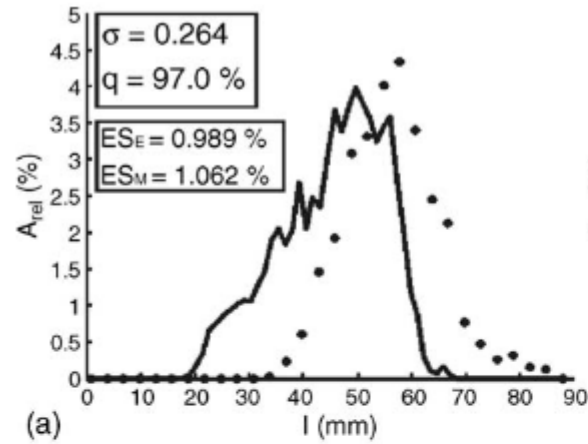
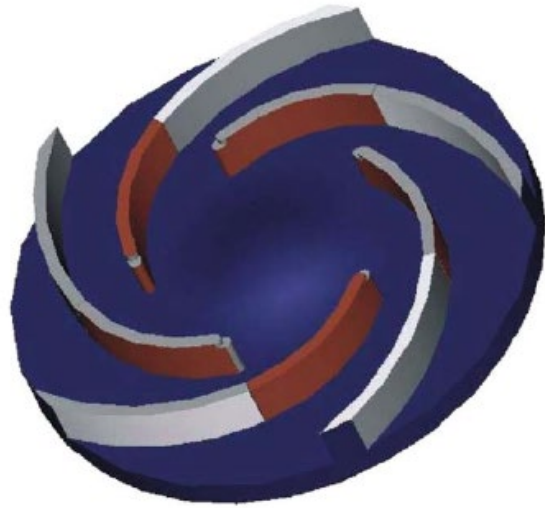
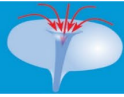

• Experiment
— Model

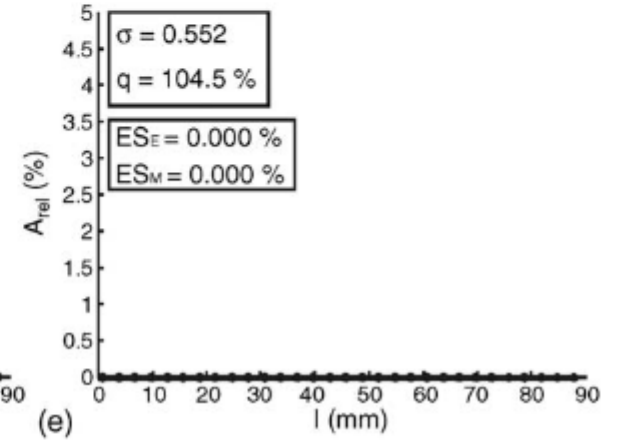
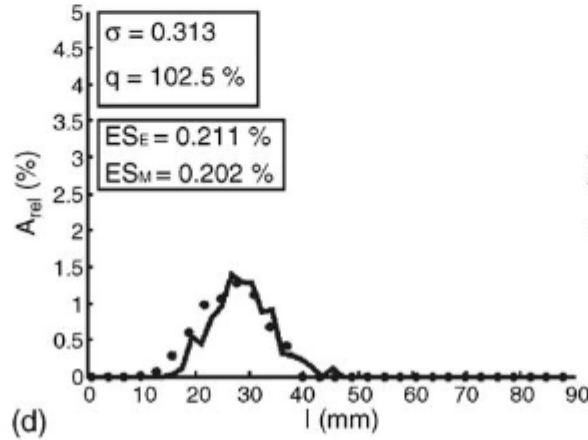
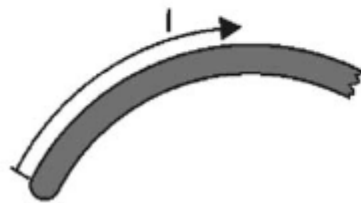

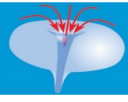

TUD IN UL (2005)



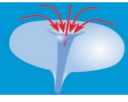

TEST DOKTORATA (2012-2015)

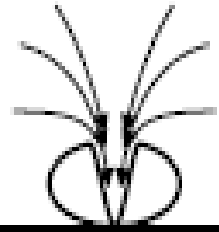
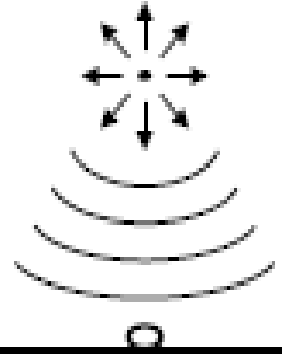
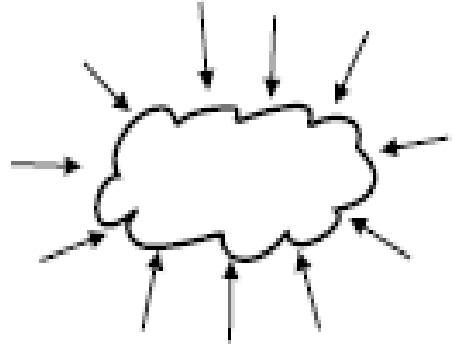

Kolaps kavitacijskega oblaka

Nastanek tlačnega vala

Nastanek mikrocurka

Nastanek luknjice

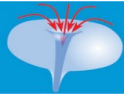

TEST DOKTORATA (2012-2015)



Kolaps kavitacijskega oblaka

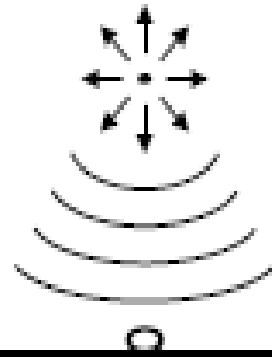

Nastanek tlačnega vala

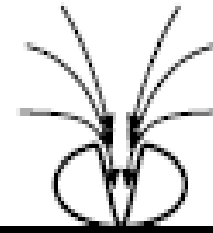

Nastanek mikrocurka



Nastanek luknjice

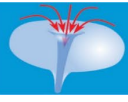

TEST DOKTORATA (2012-2019)

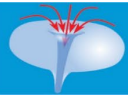

TEST DOKTORATA (2012-2019)

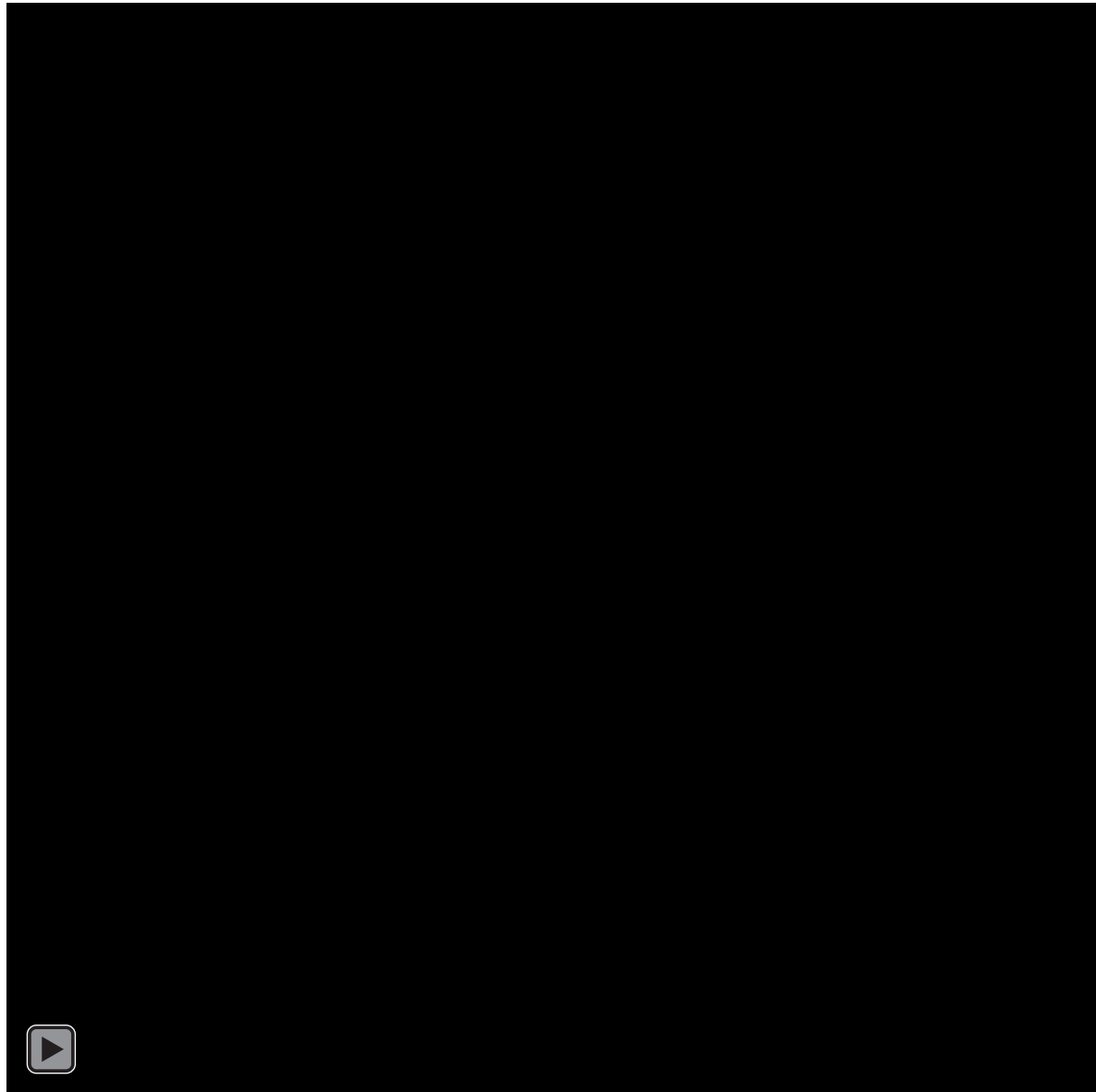

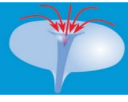

TEST DOKTORATA (2012-2019)

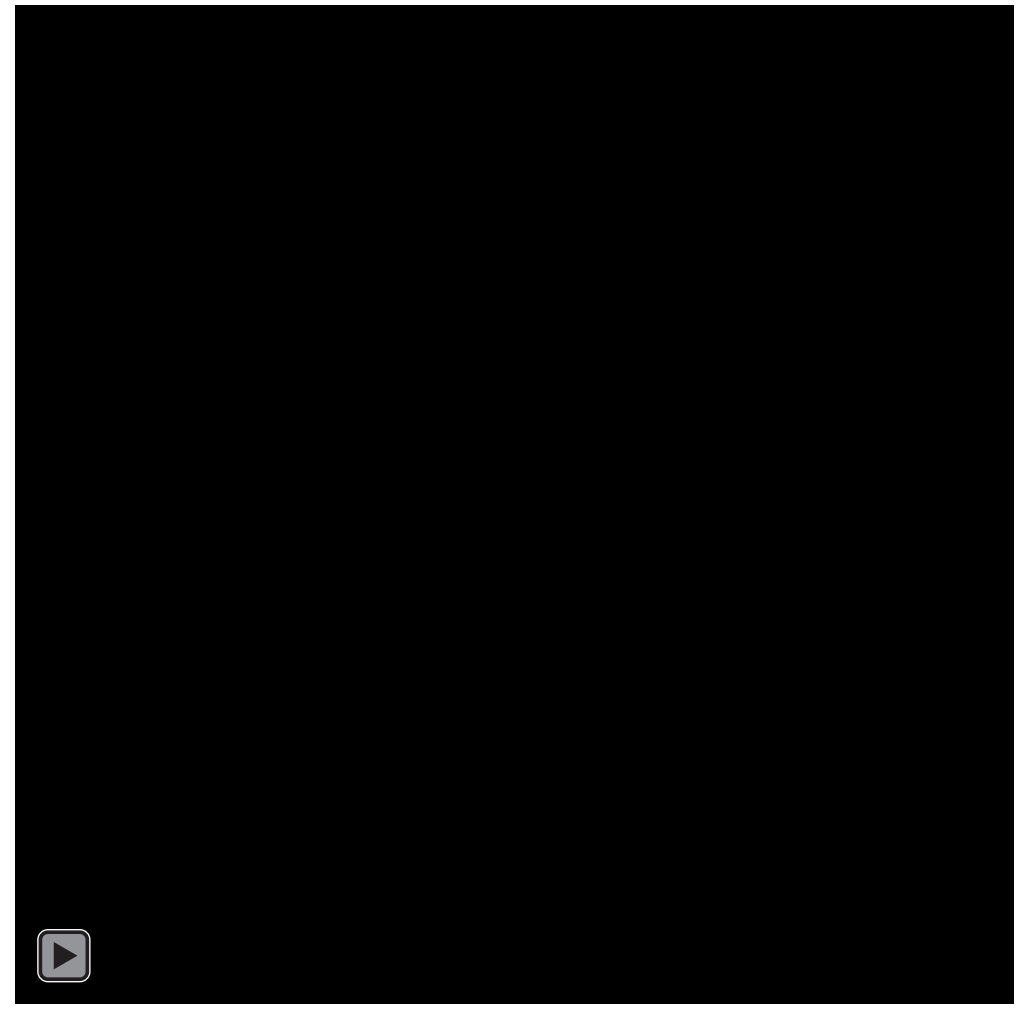
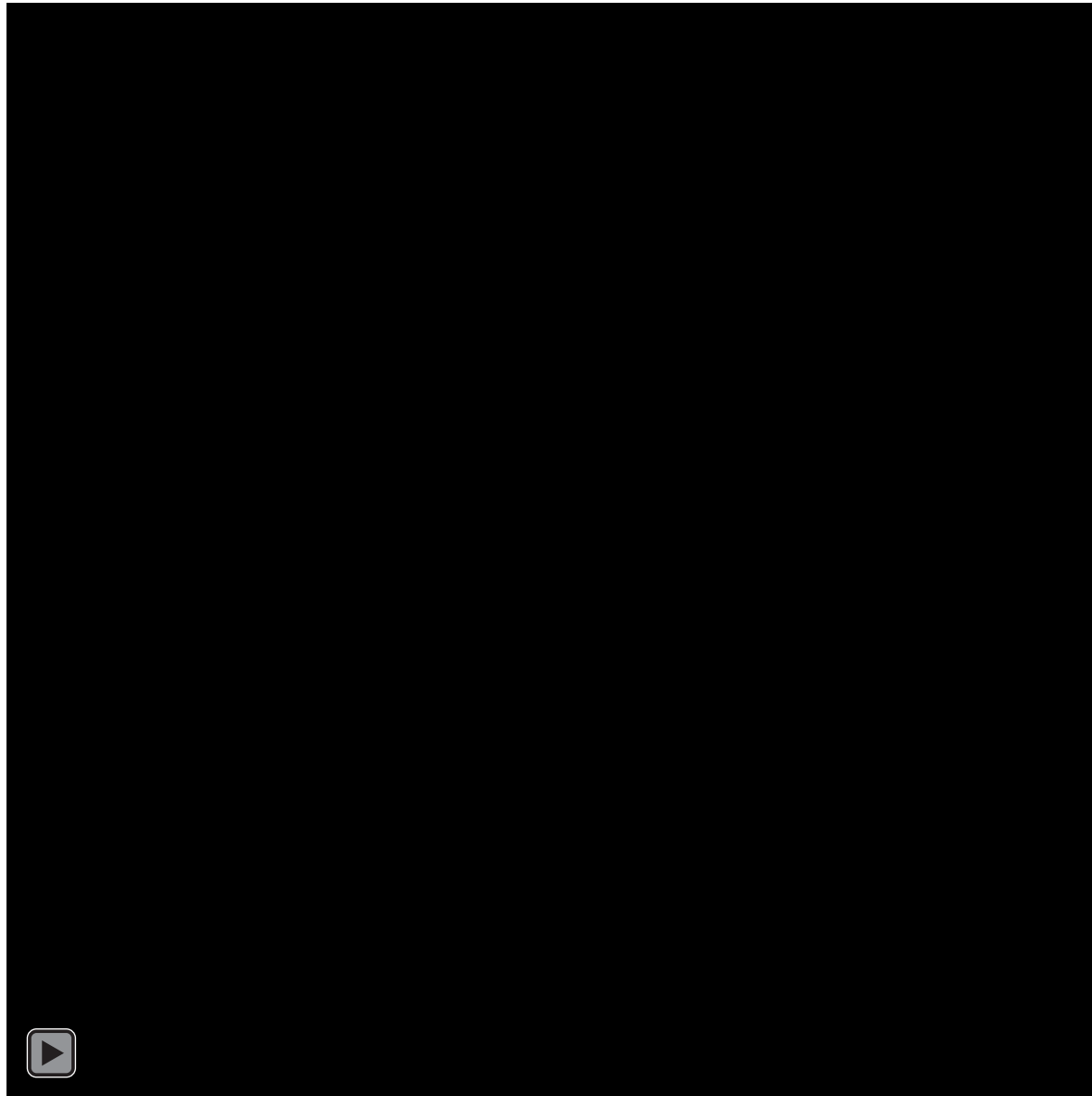



TEST DOKTORATA (2012-2019)

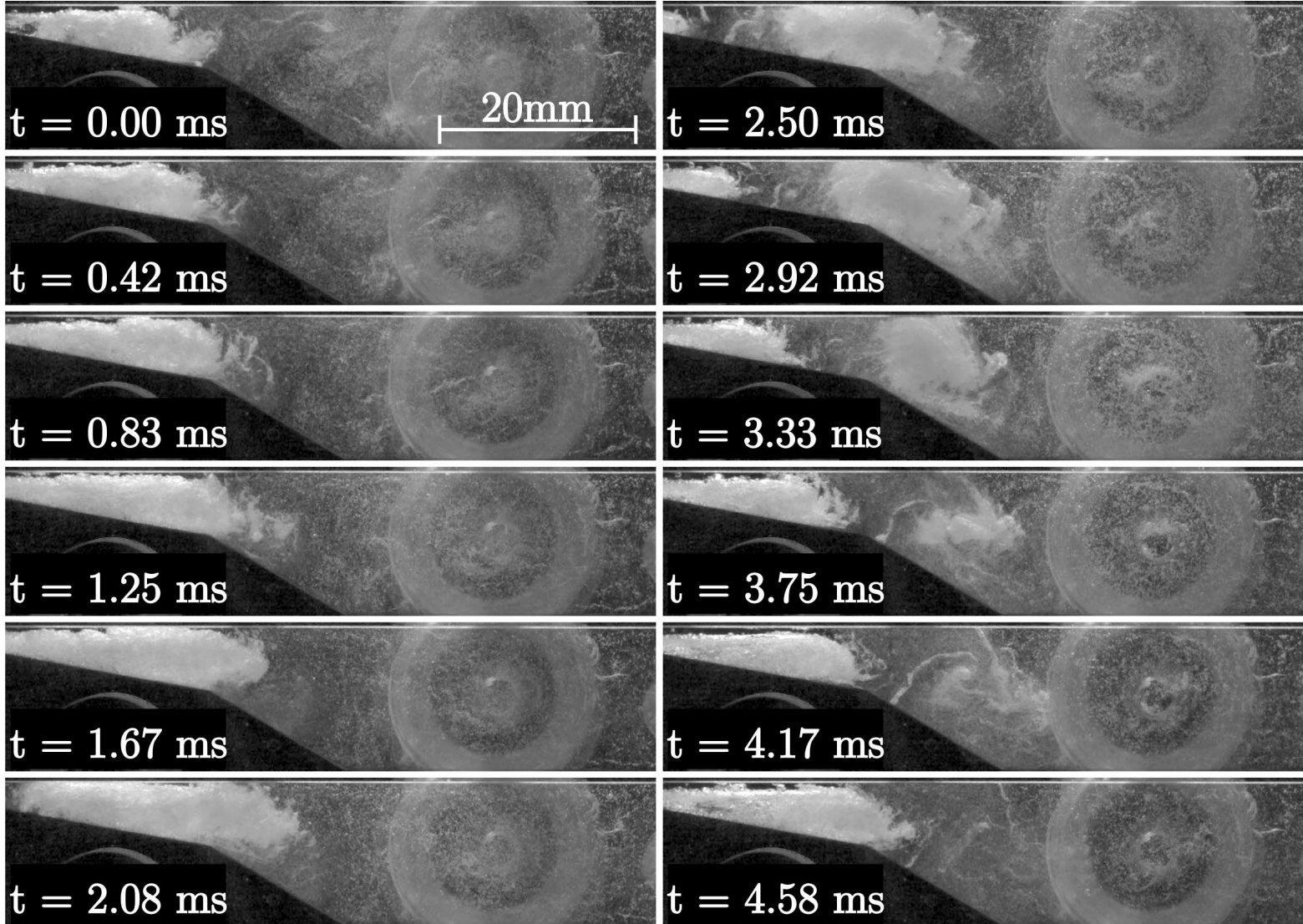

PETKOVŠEK, Martin, HOČEVAR, Marko, DULAR, Matevž. **Visualization and measurements of shock waves in cavitating flow.** *Experimental thermal and fluid science*. 2020, vol. 119

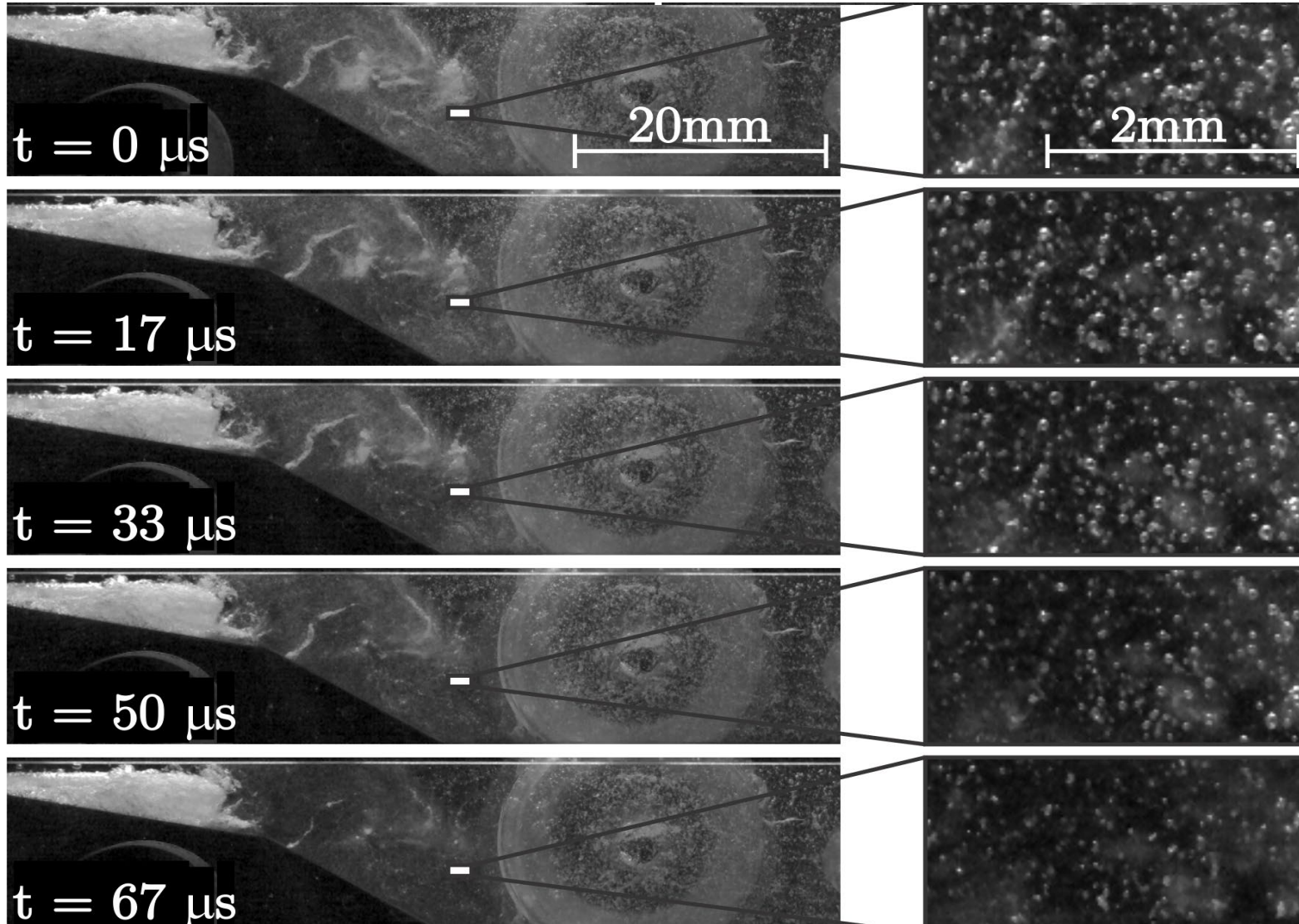
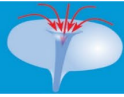

PETKOVŠEK, Martin, HOČEVAR, Marko, DULAR, Matevž. **Visualization and measurements of shock waves in cavitating flow.** *Experimental thermal and fluid science*. 2020, vol. 119

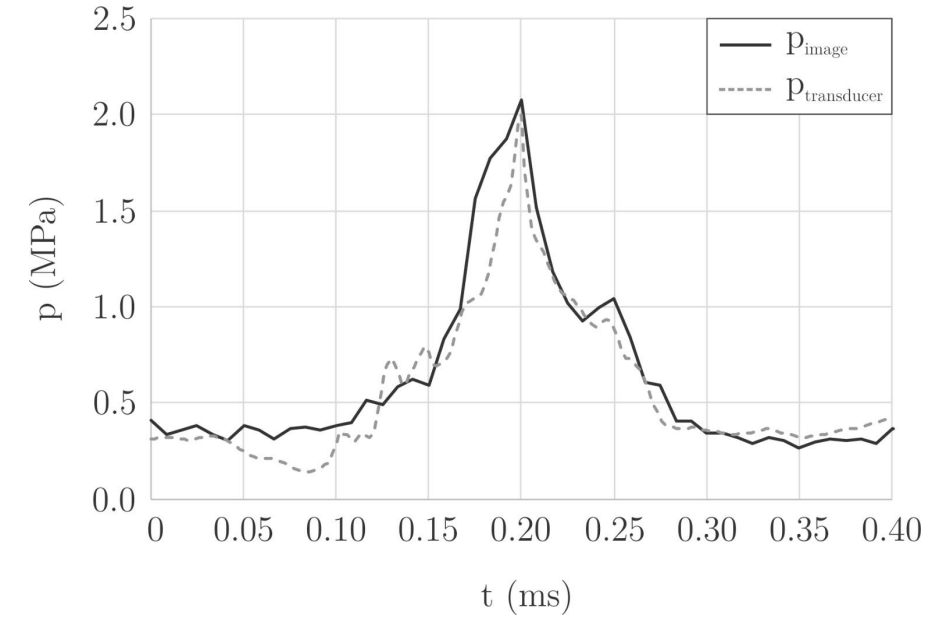
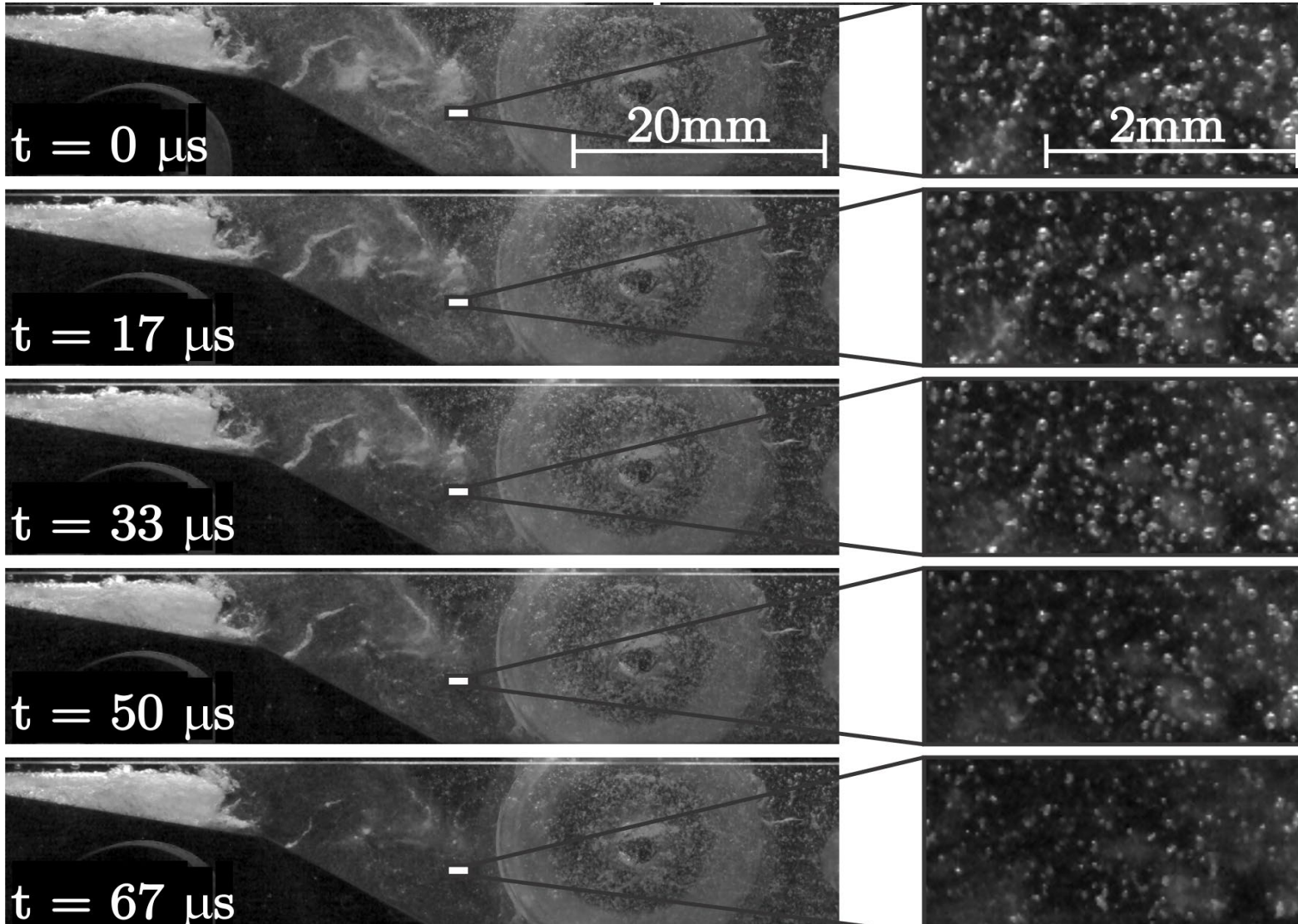
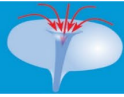

PETKOVŠEK, Martin, HOČEVAR, Marko, DULAR, Matevž. **Visualization and measurements of shock waves in cavitating flow.** *Experimental thermal and fluid science*. 2020, vol. 119

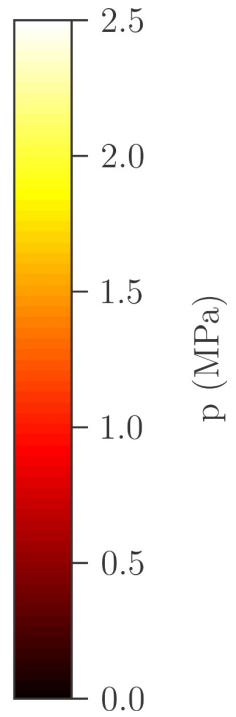
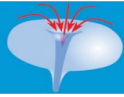

PETKOVŠEK, Martin, HOČEVAR, Marko, DULAR, Matevž. **Visualization and measurements of shock waves in cavitating flow.** *Experimental thermal and fluid science.* 2020, vol. 119

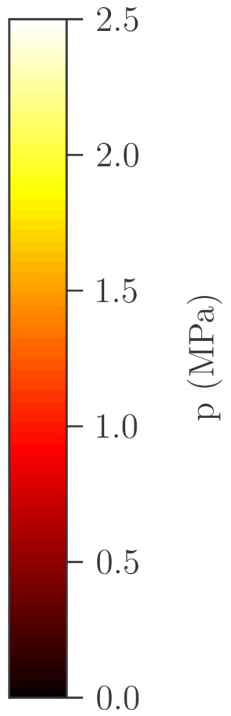
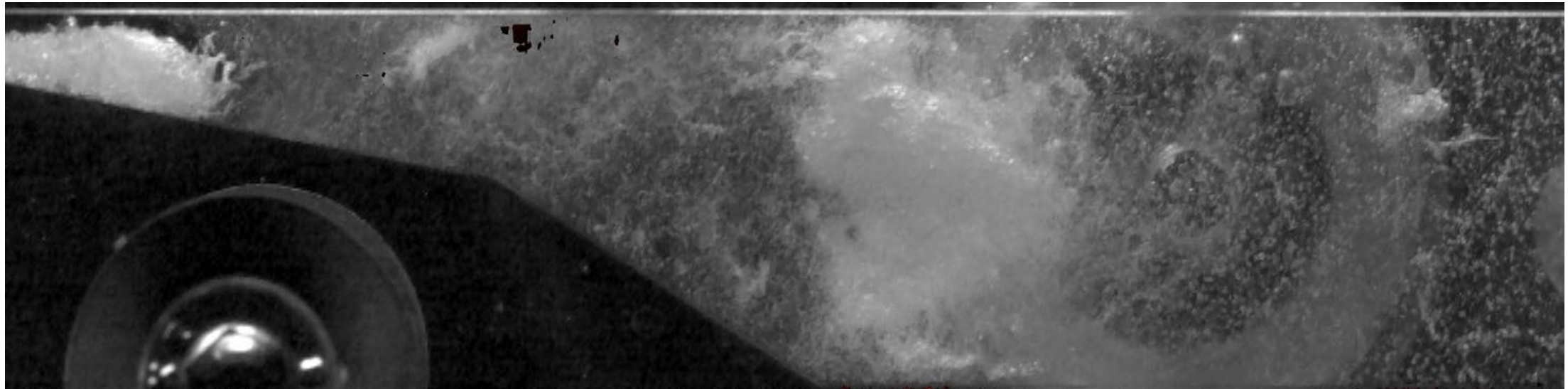
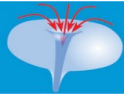

PETKOVŠEK, Martin, HOČEVAR, Marko, DULAR, Matevž. **Visualization and measurements of shock waves in cavitating flow.** *Experimental thermal and fluid science.* 2020, vol. 119

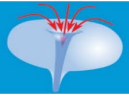

TEST DOKTORATA (2012-2019)

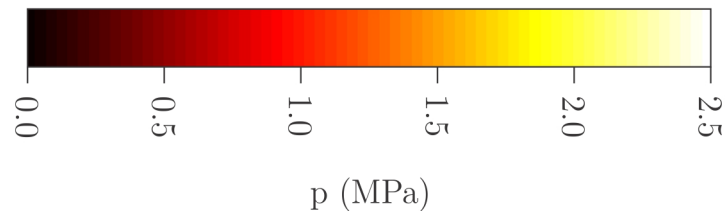
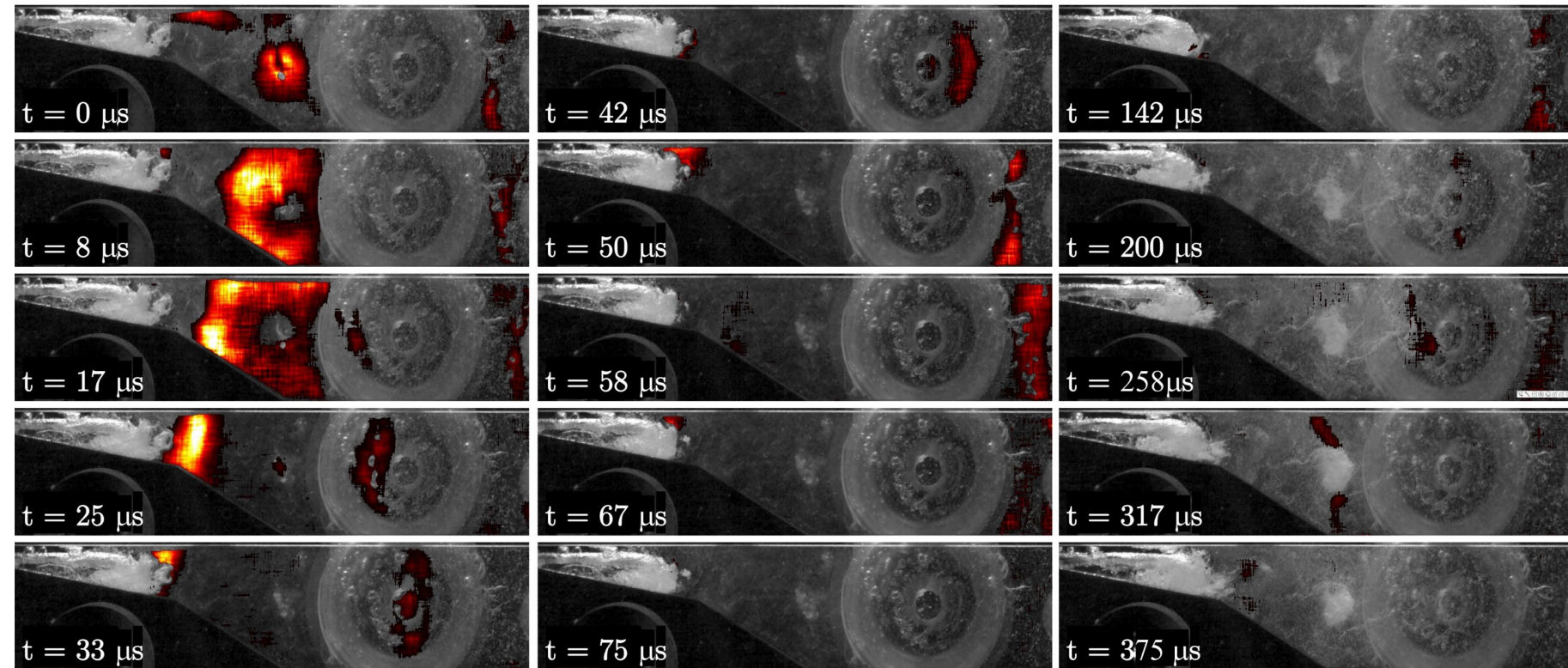

PETKOVŠEK, Martin, HOČEVAR, Marko, DULAR, Matevž. **Visualization and measurements of shock waves in cavitating flow.** *Experimental thermal and fluid science*. 2020, vol. 119

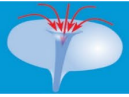

TEST DOKTORATA (2012-2019)

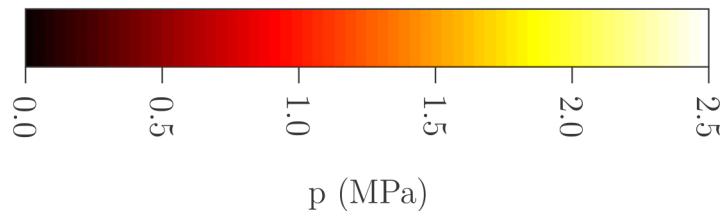
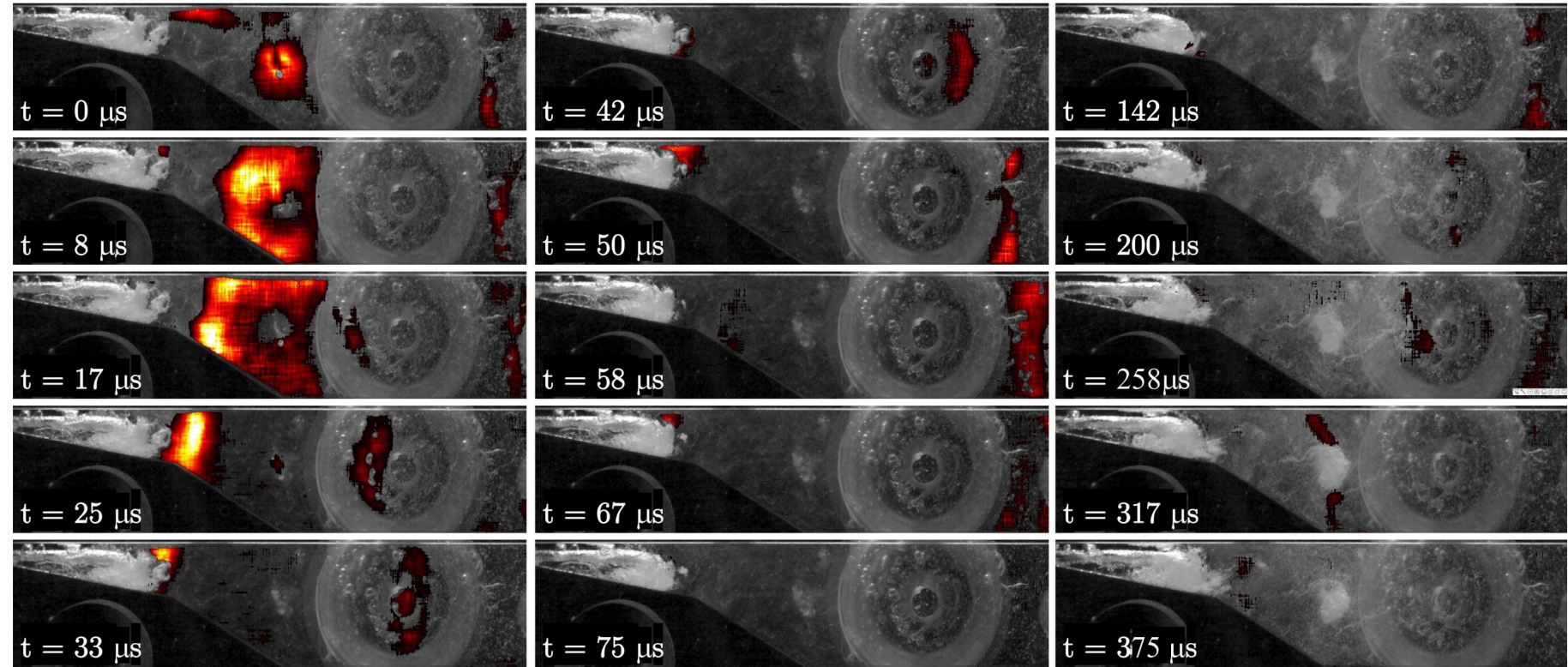
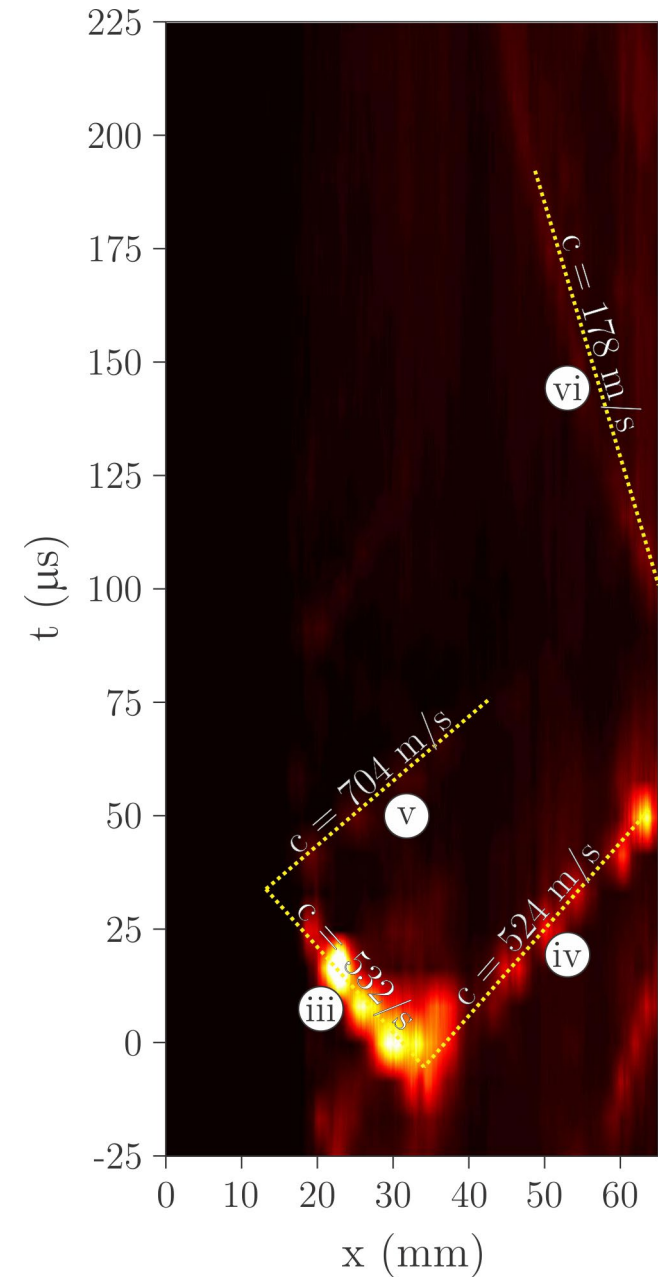

PETKOVŠEK, Martin, HOČEVAR, Marko, DULAR, Matevž. **Visualization and measurements of shock waves in cavitating flow.** *Experimental thermal and fluid science*. 2020, vol. 119



TEST DOKTORATA (2012-2019)



Kolaps kavitacijskega oblaka

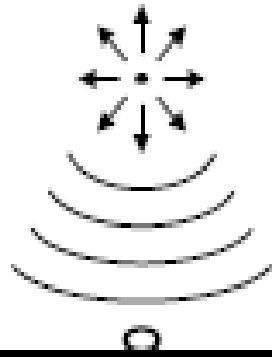

Nastanek tlačnega vala

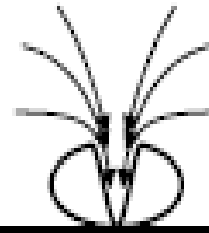

Nastanek mikrocurka



Nastanek luknjice



TEST DOKTORATA (2012-2019)

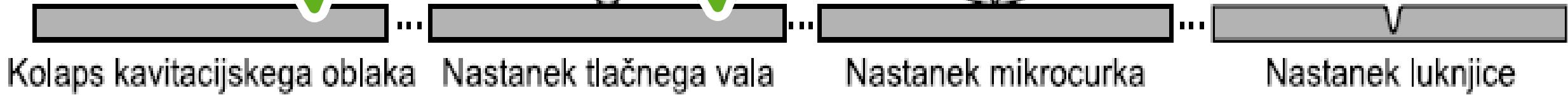
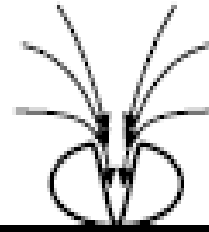
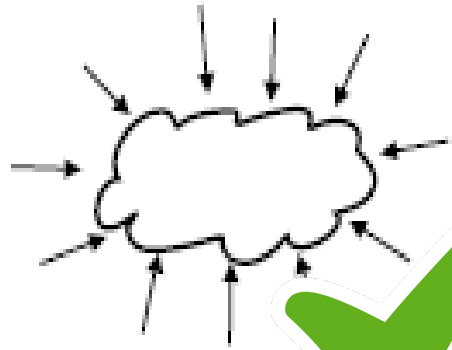

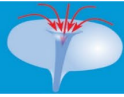

TEST DOKTORATA (2012-2019)

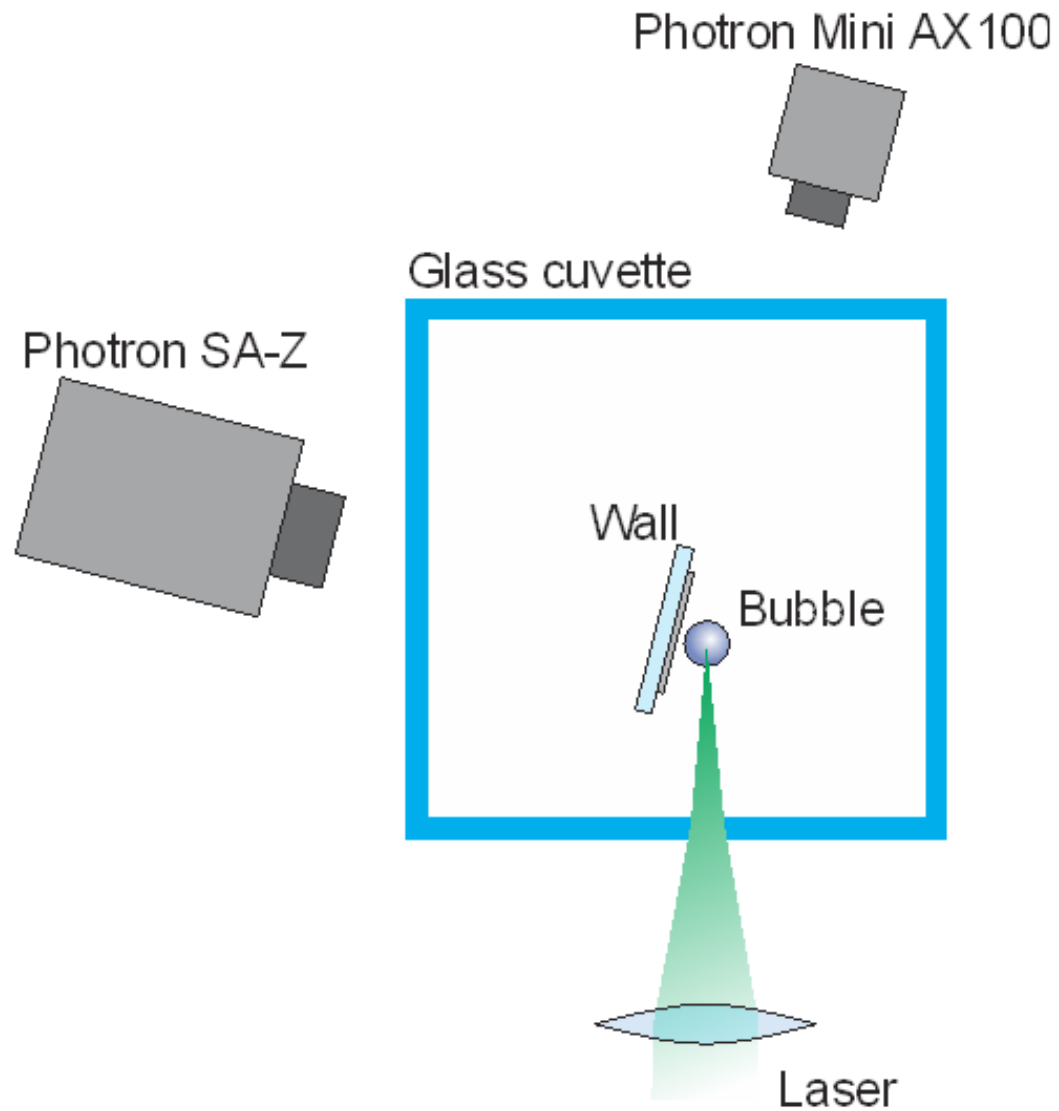

Matevz, DULAR, Tomaž POŽAR, Jure ZEVNIK, Rok PETKOVSEK. **High speed observation of damage created by a collapse of a single cavitation bubble**, *Wear*, Vol. 418-419, pp. 13-23, 2019

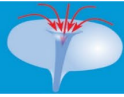

TEST DOKTORATA (2012-2019)

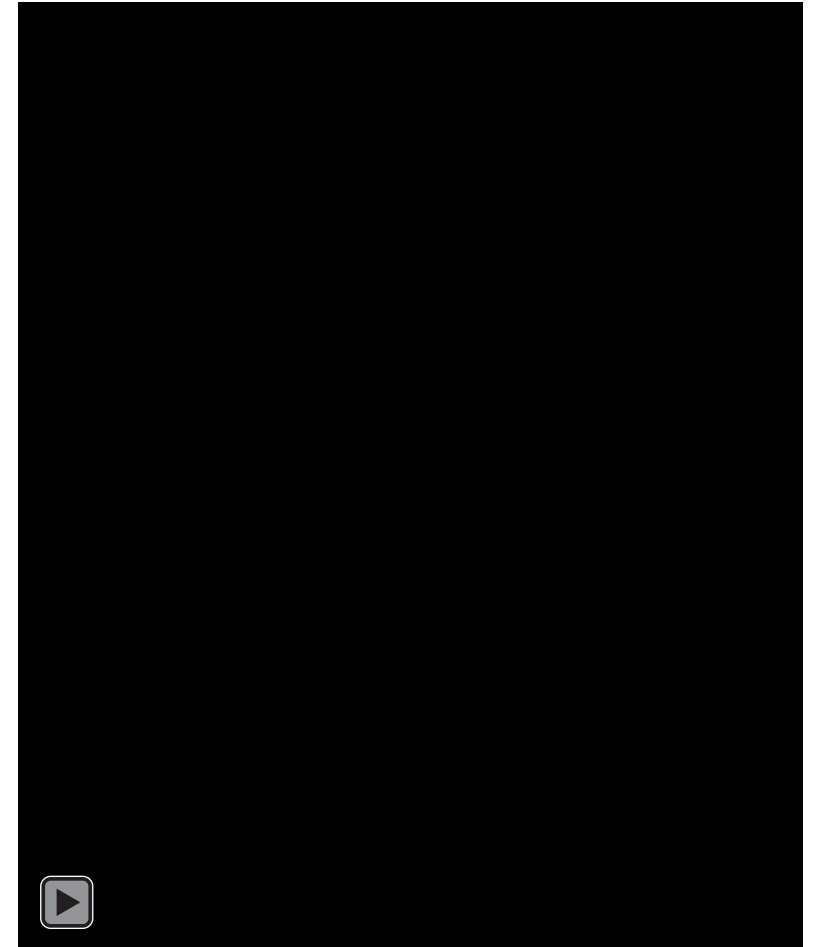
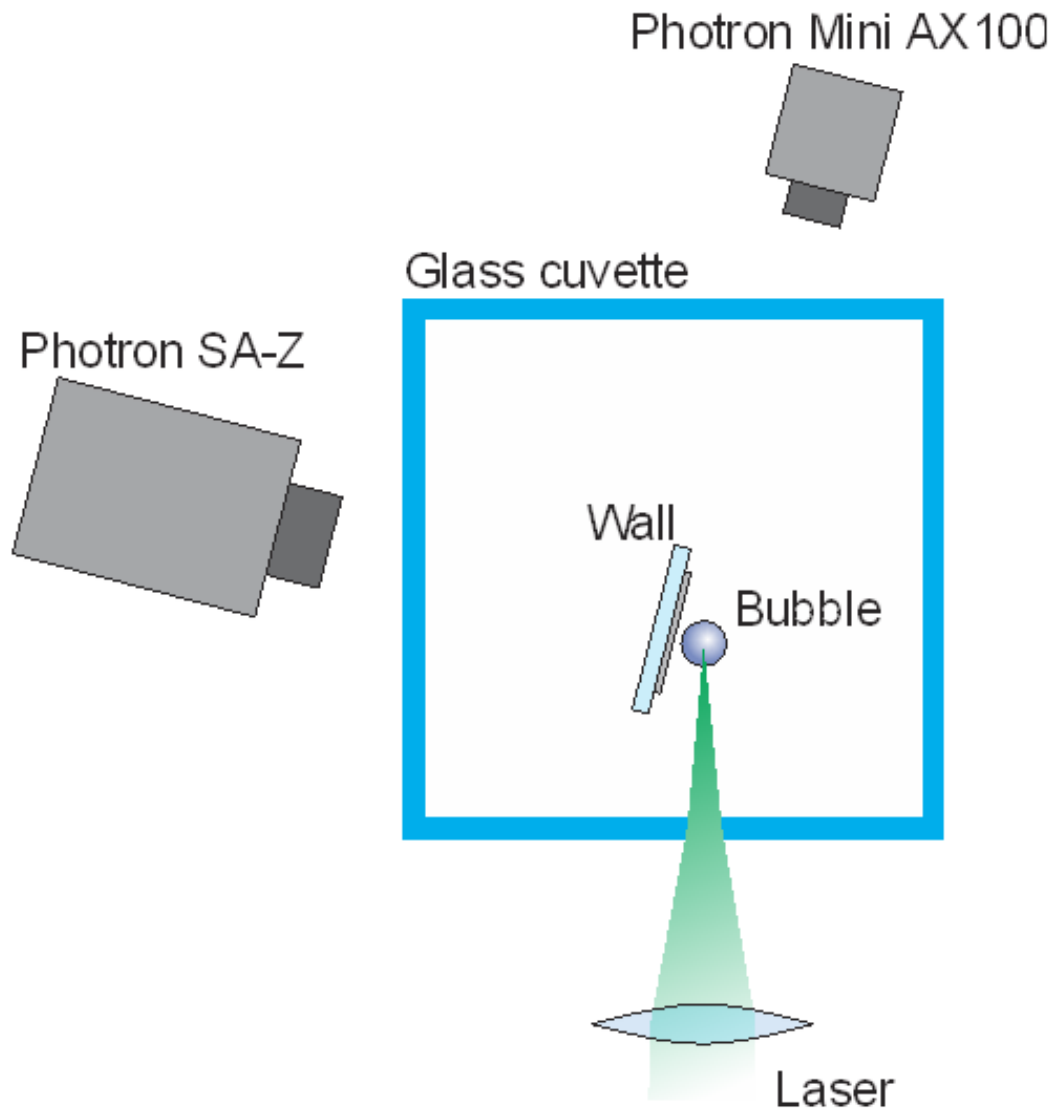

Matevz, DULAR, Tomaž POŽAR, Jure ZEVNIK, Rok PETKOVSEK. **High speed observation of damage created by a collapse of a single cavitation bubble**, *Wear*, Vol. 418-419, pp. 13-23, 2019

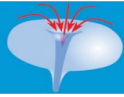

TEST DOKTORATA (2012-2019)

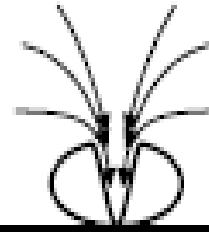
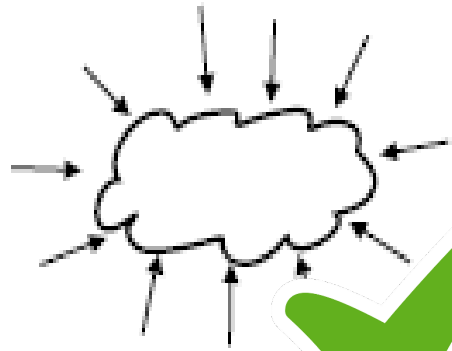

Kolaps kavitacijskega oblaka

Nastanek tlačnega vala

Nastanek mikrocurka

Nastanek luknjice

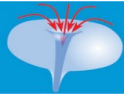

TEST DOKTORATA (2012-2019)

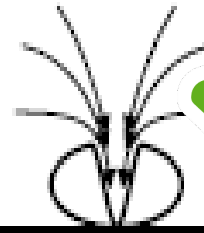
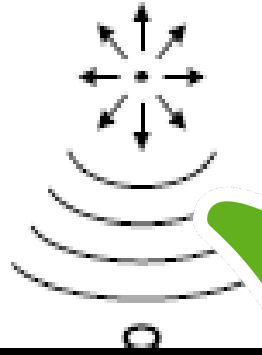
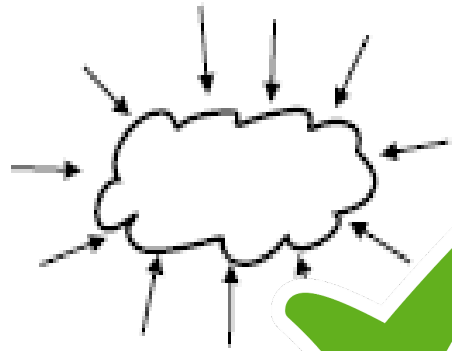

...



...



...



Kolaps kavitacijskega oblaka

Nastanek tlačnega vala

Nastanek mikrocurka

Nastanek luknjice



TEST DOKTORATA (2012-2019)

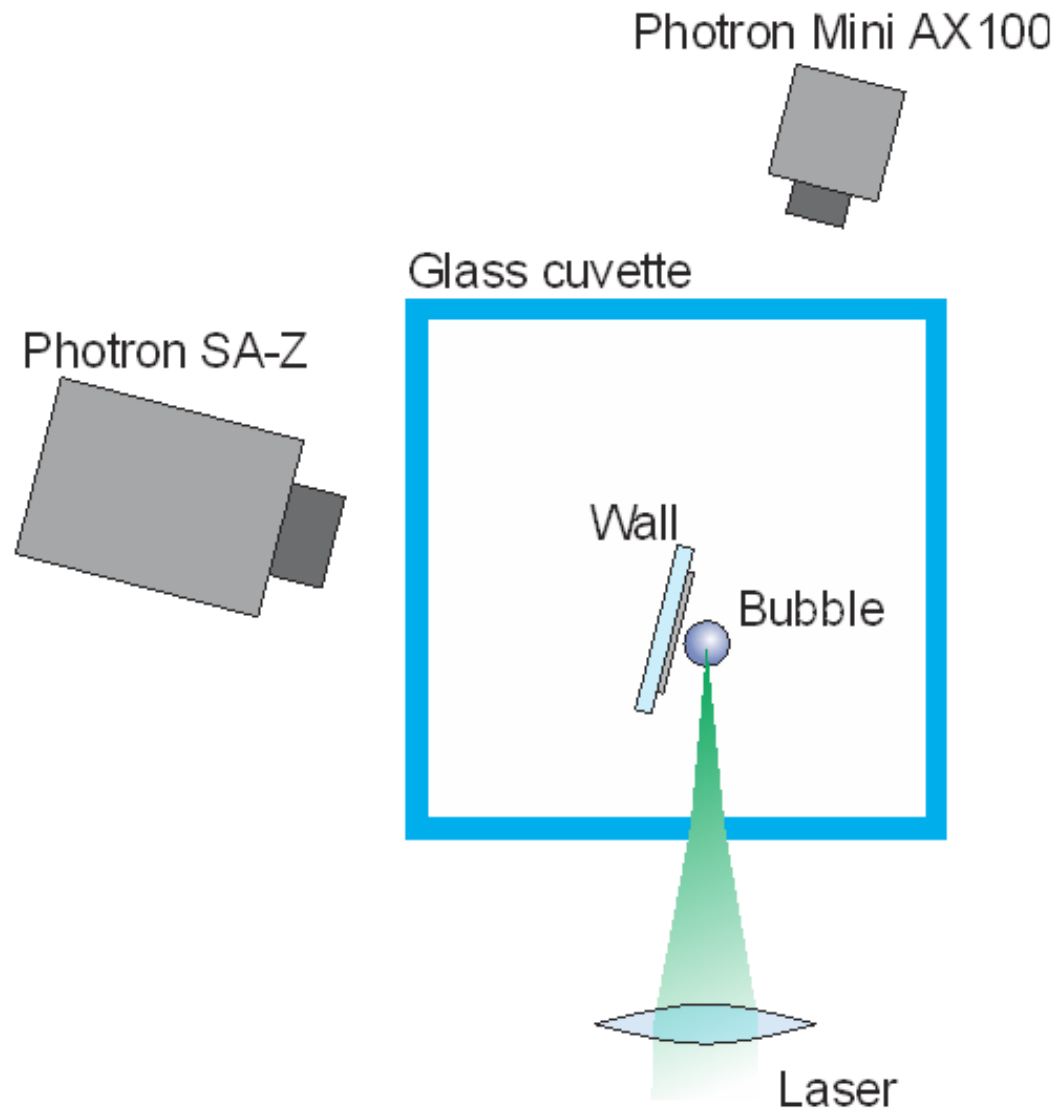

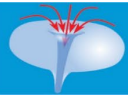

TEST DOKTORATA (2012-2019)

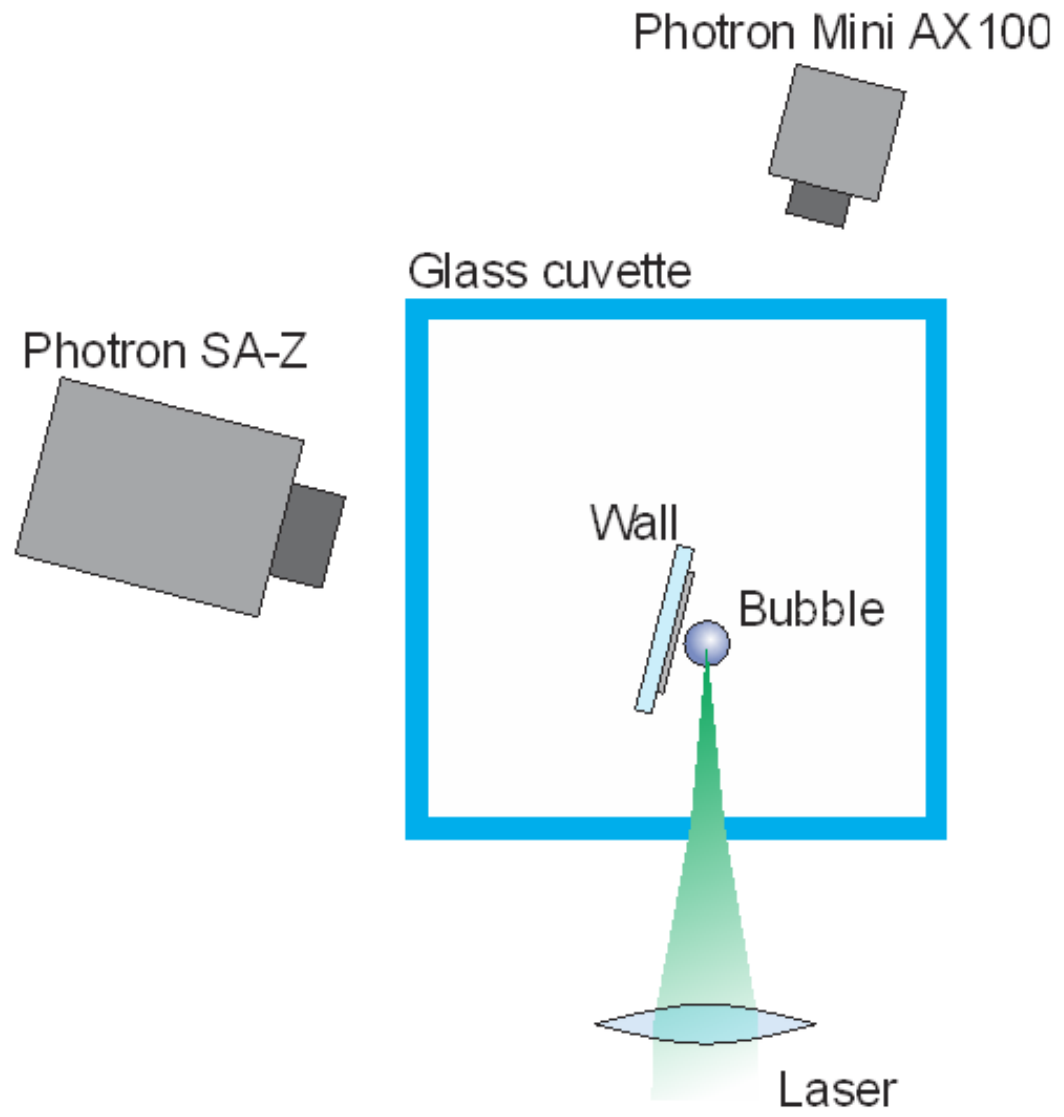



TEST DOKTORATA (2012-2019)

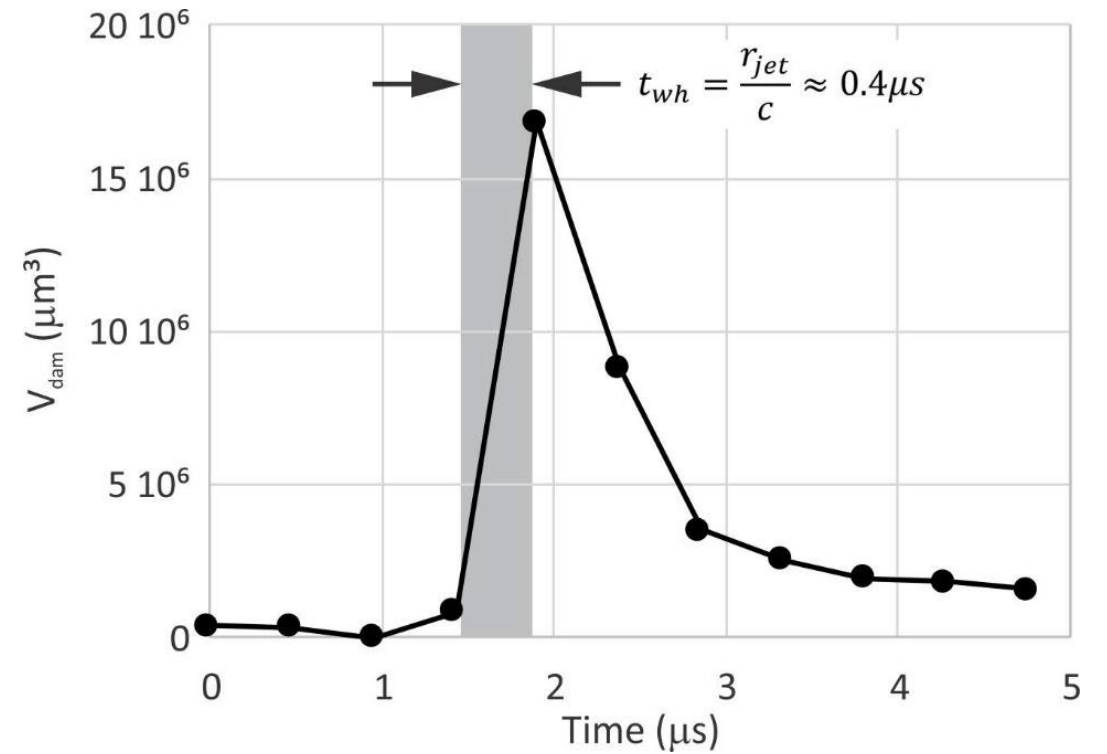
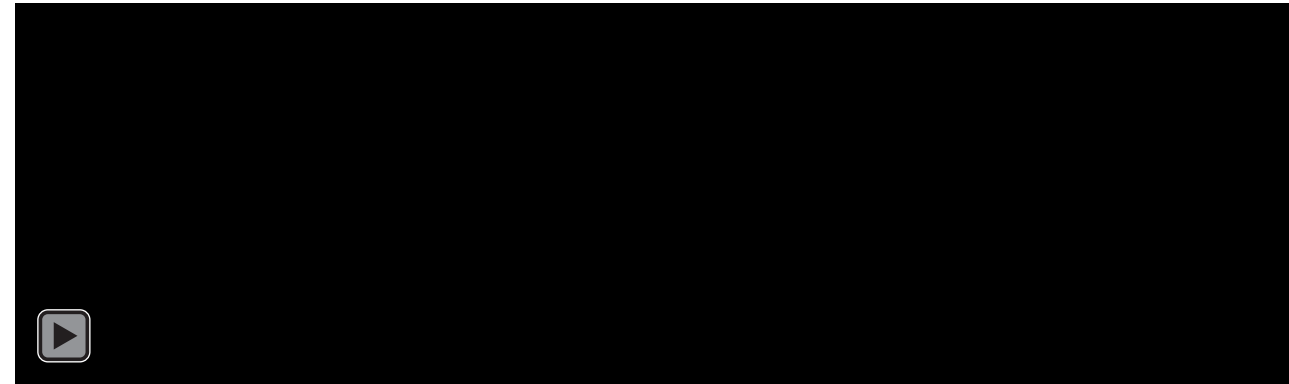
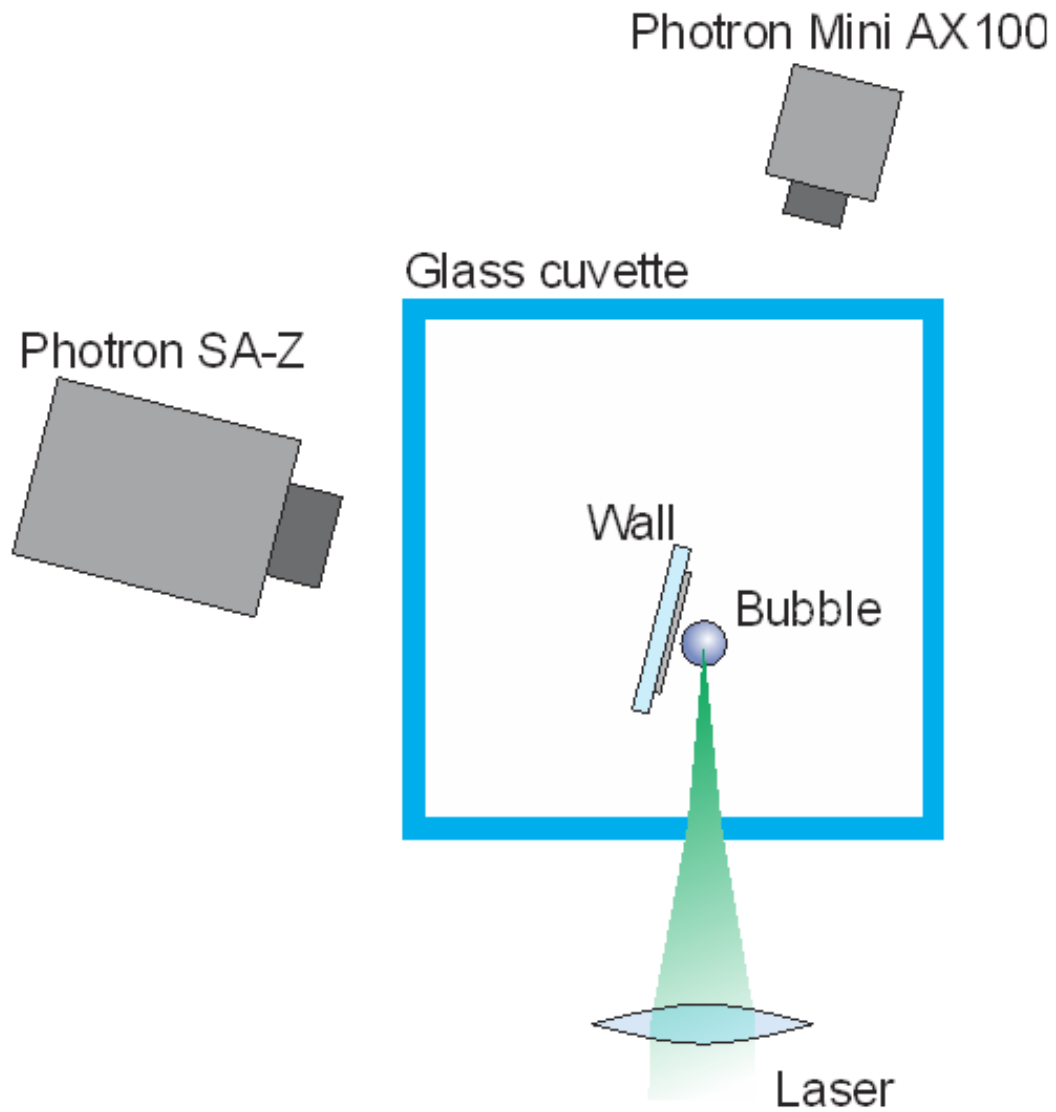



TEST DOKTORATA (2012-2019)

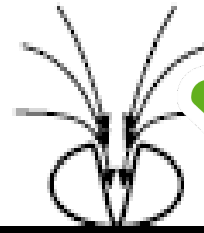
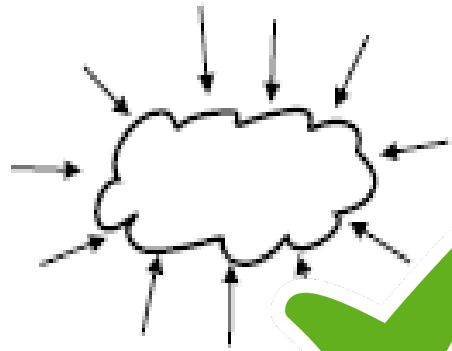

...



...



...



Kolaps kavitacijskega oblaka

Nastanek tlačnega vala

Nastanek mikrocurka

Nastanek luknjice

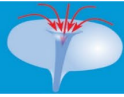

TEST DOKTORATA (2012-2019)

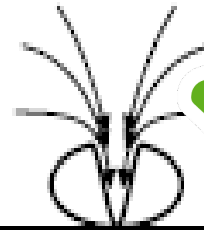
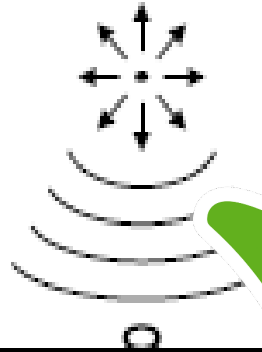
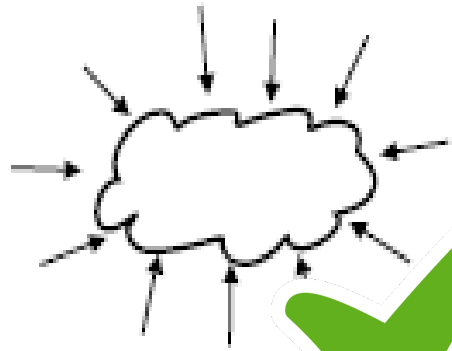

Kolaps kavitacijskega oblaka

Nastanek tlačnega vala

Nastanek mikrocurka

Nastanek luknjice

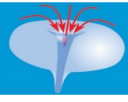

TEST DOKTORATA (2012-2019)

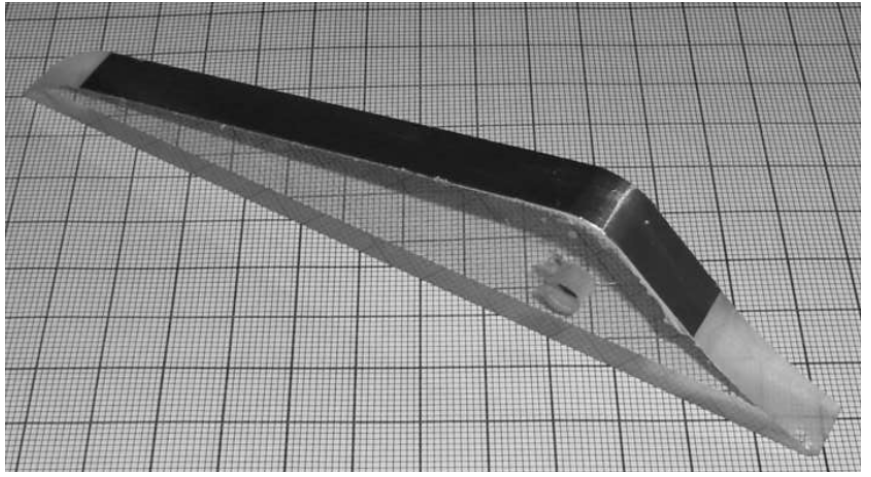

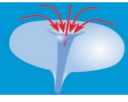

TEST DOKTORATA (2012-2019)

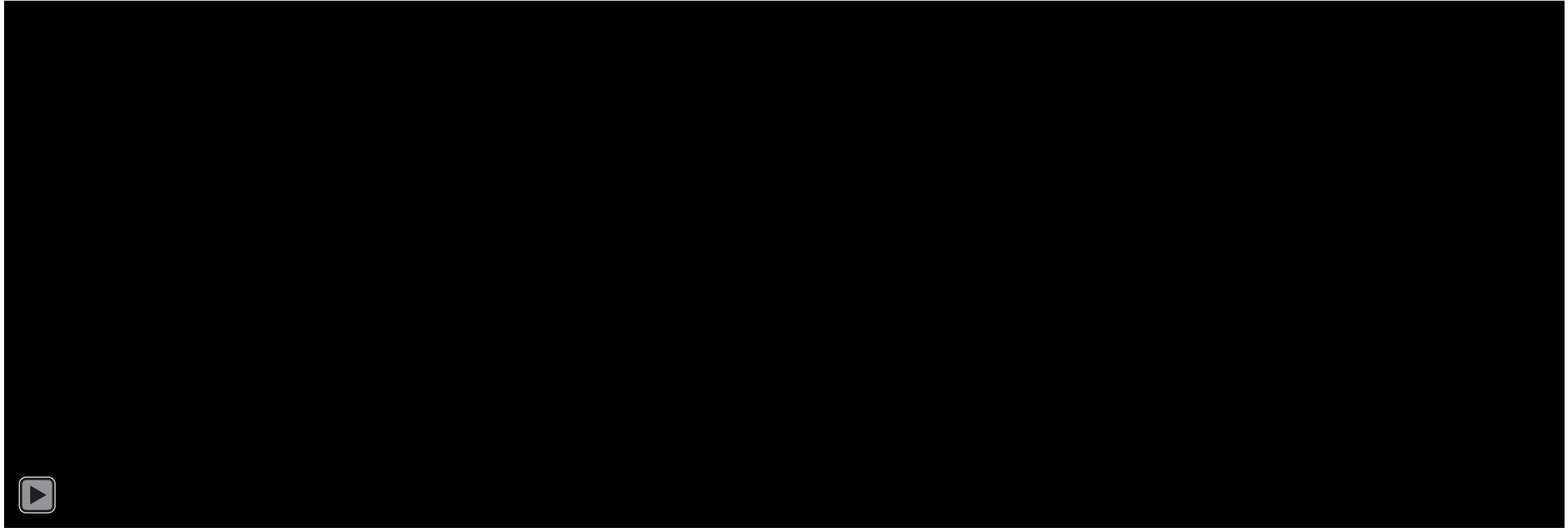
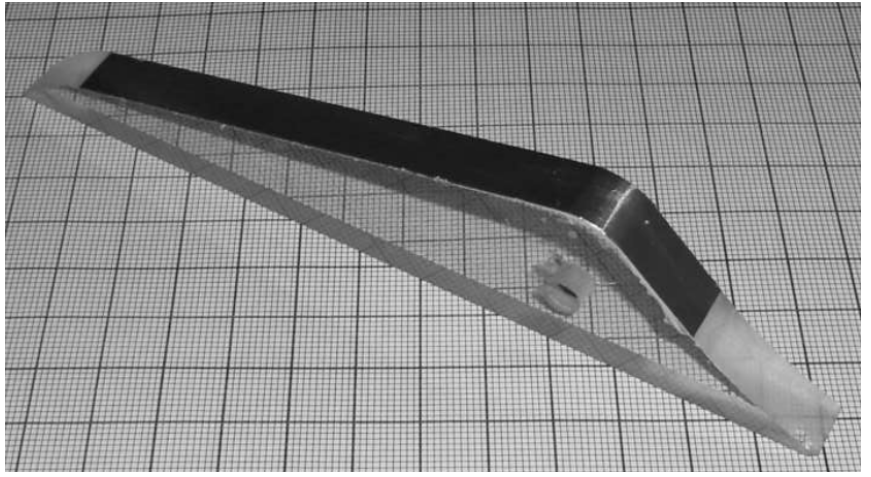

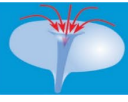

TEST DOKTORATA (2012-2019)

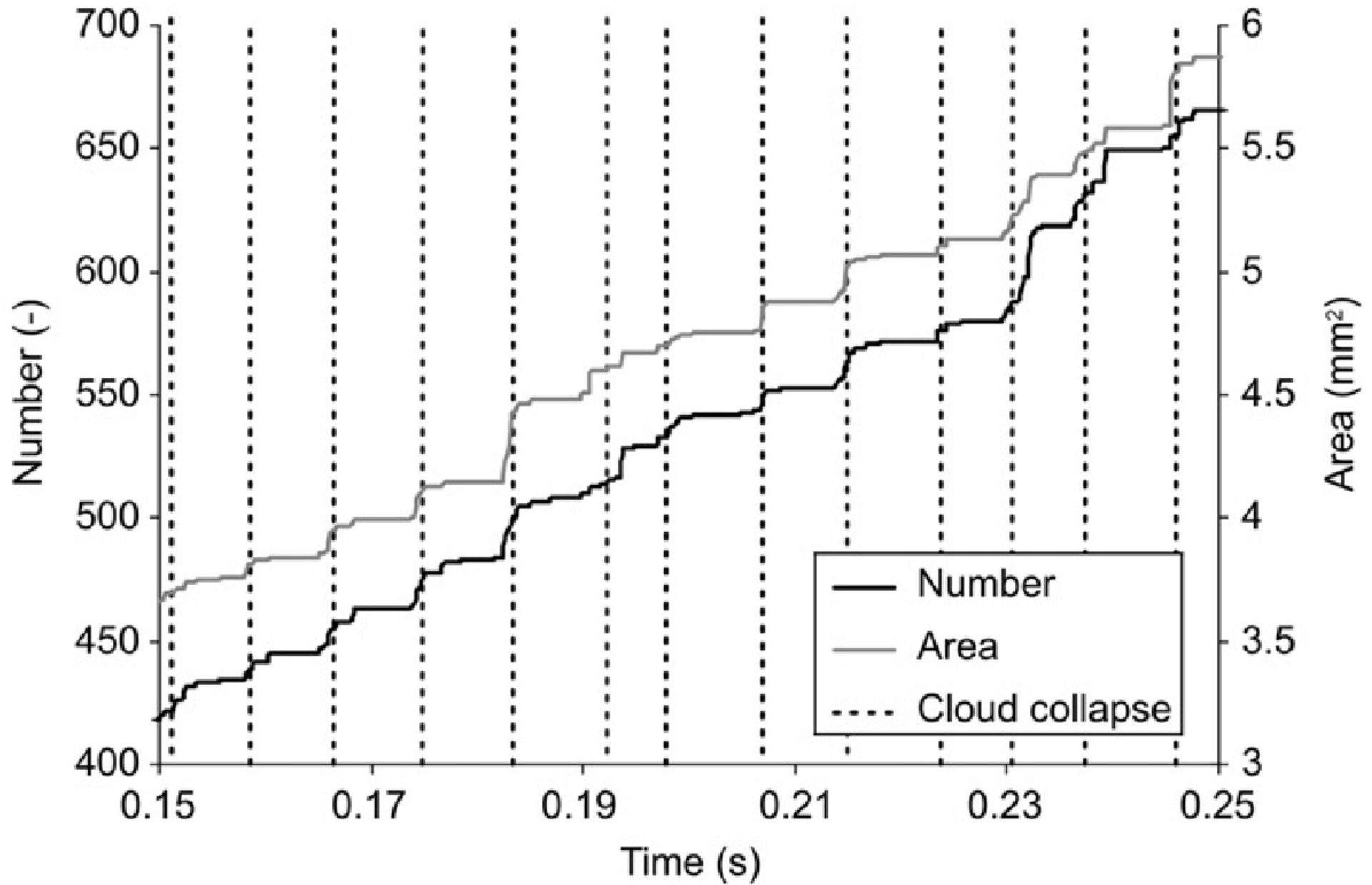



TEST DOKTORATA (2012-2019)

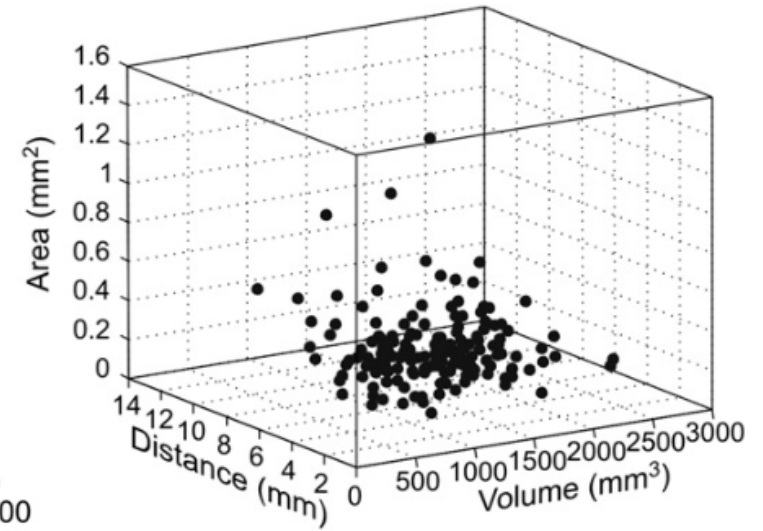
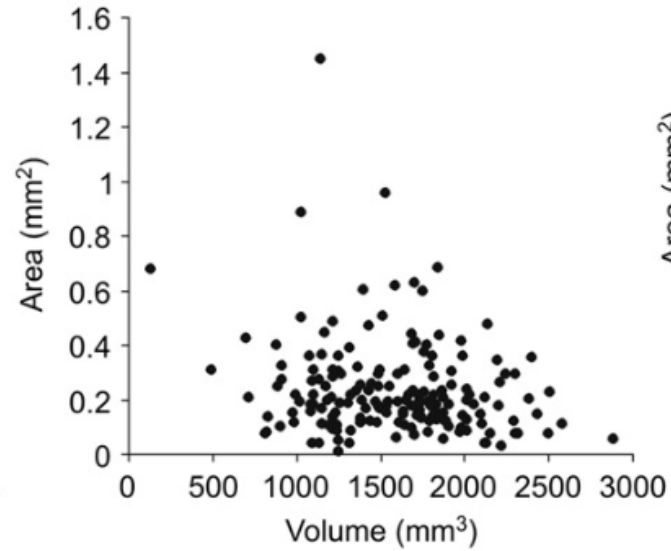
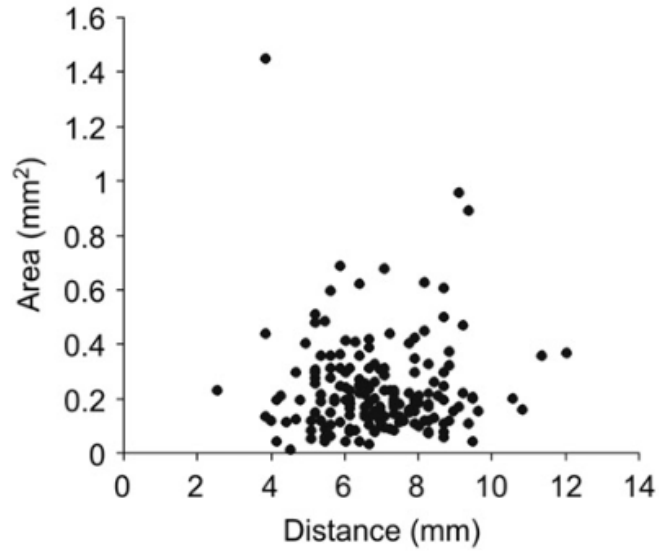



TEST DOKTORATA (2012-2019)

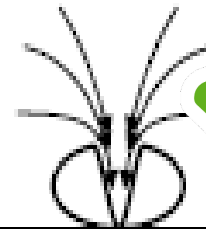
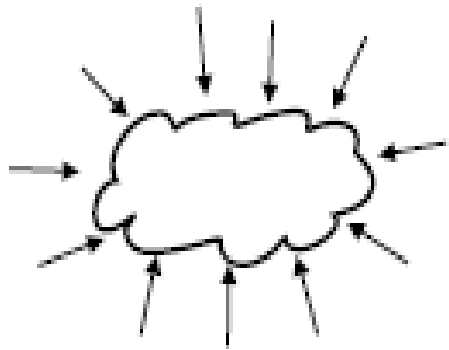
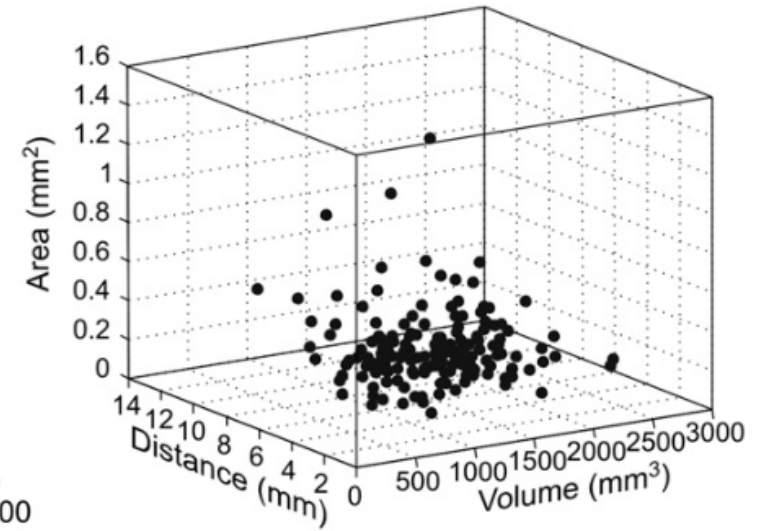
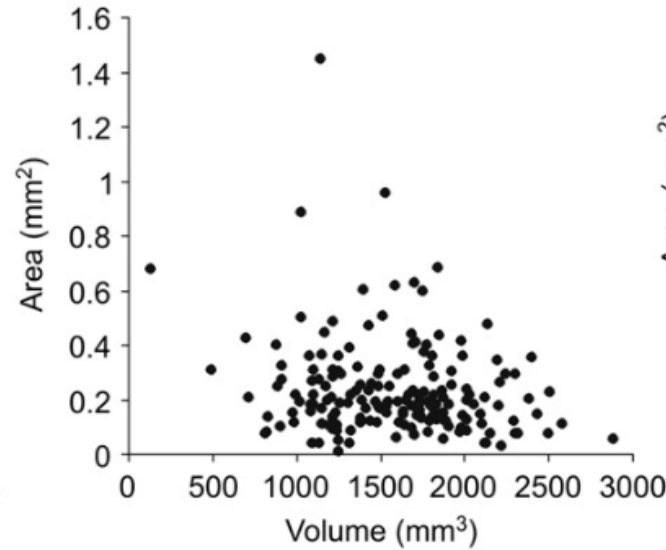
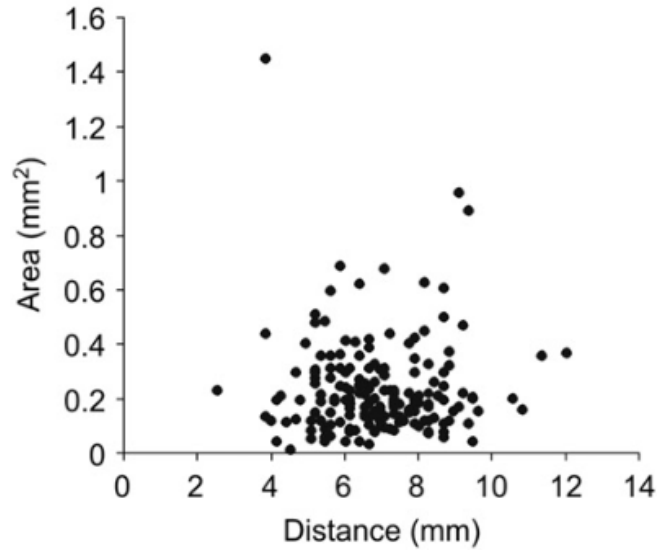

Kolaps kavitacijskega oblaka

Nastanek tlačnega vala

Nastanek mikrocurka

Nastanek luknjice



TEST DOKTORATA (2012-2019)

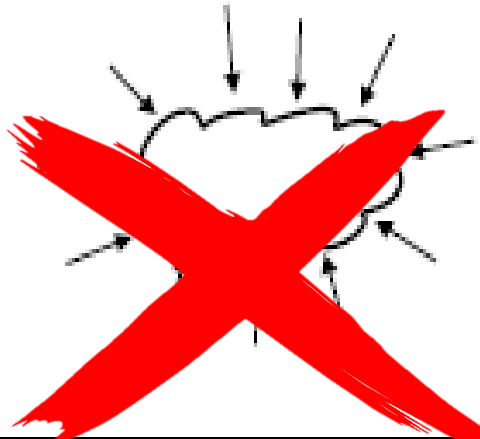
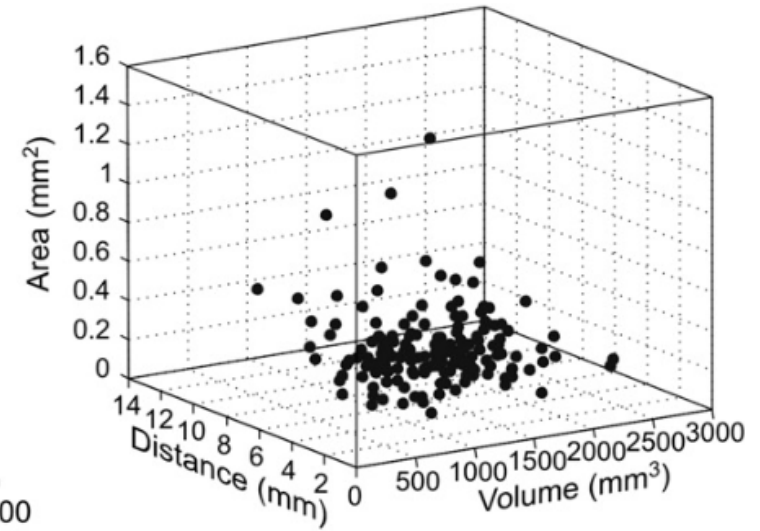
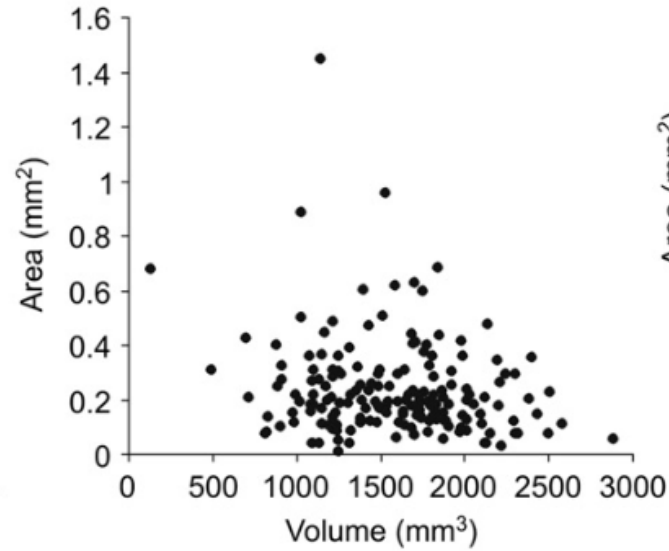
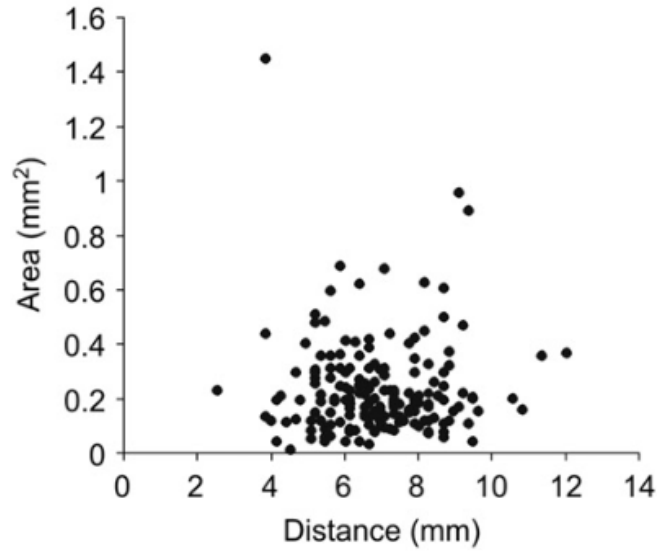

Kolaps kavitacijskega oblaka



Nastanek tlačnega vala



Nastanek mikrocurka



Nastanek luknjice



TEST DOKTORATA (2012-2019)

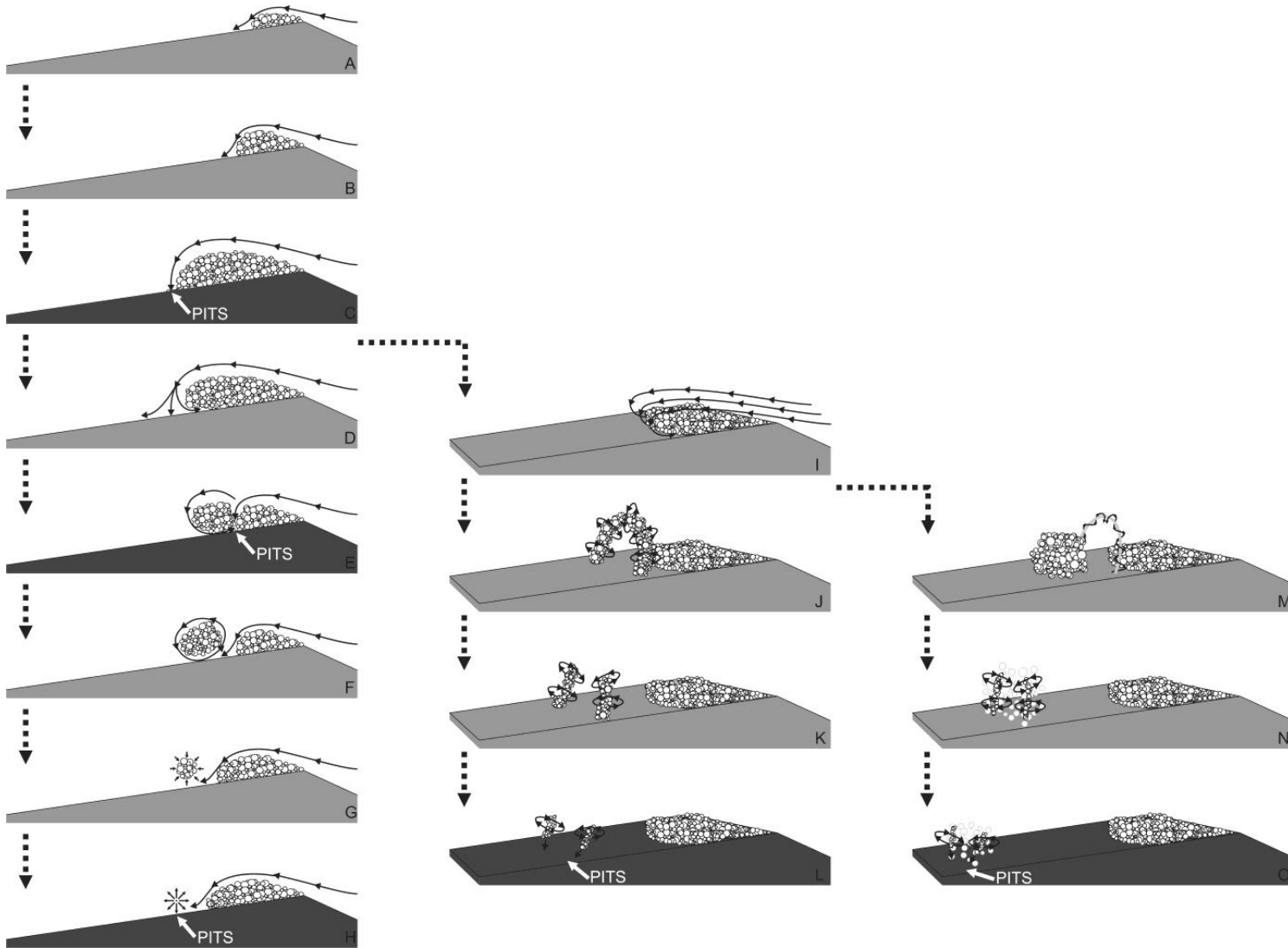

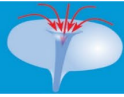

TEST DOKTORATA (2012-2019)

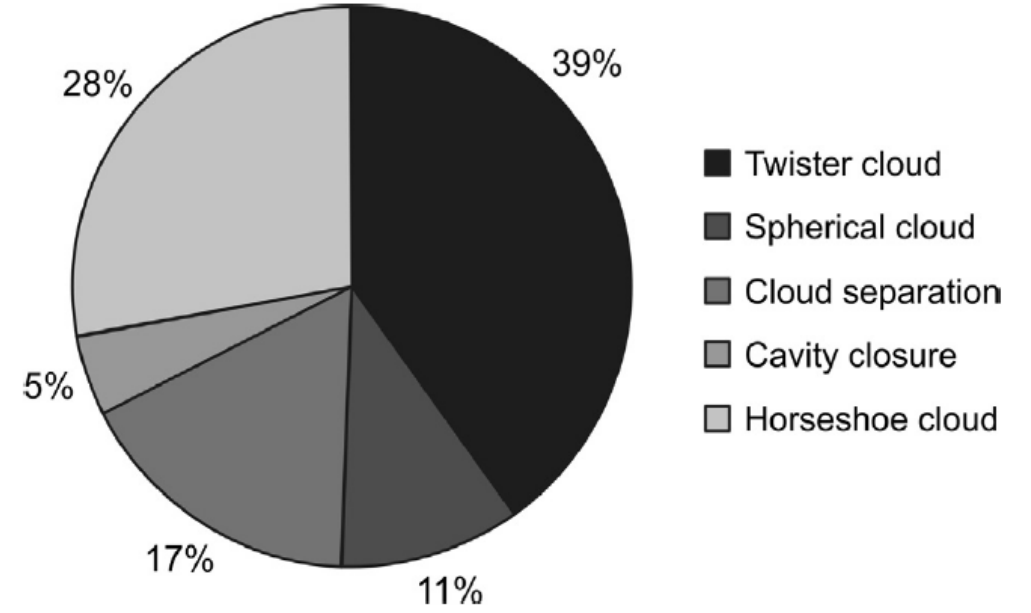
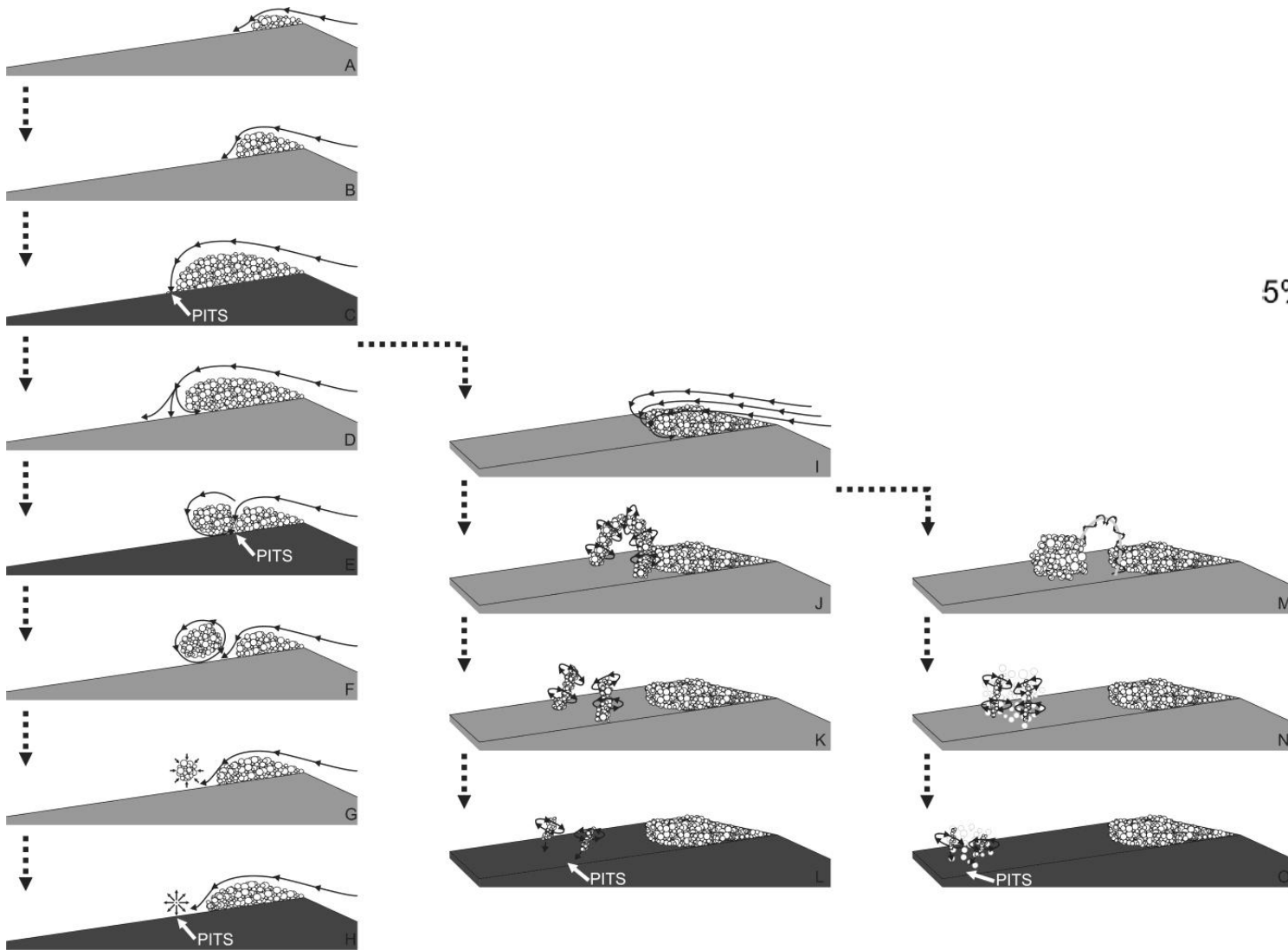
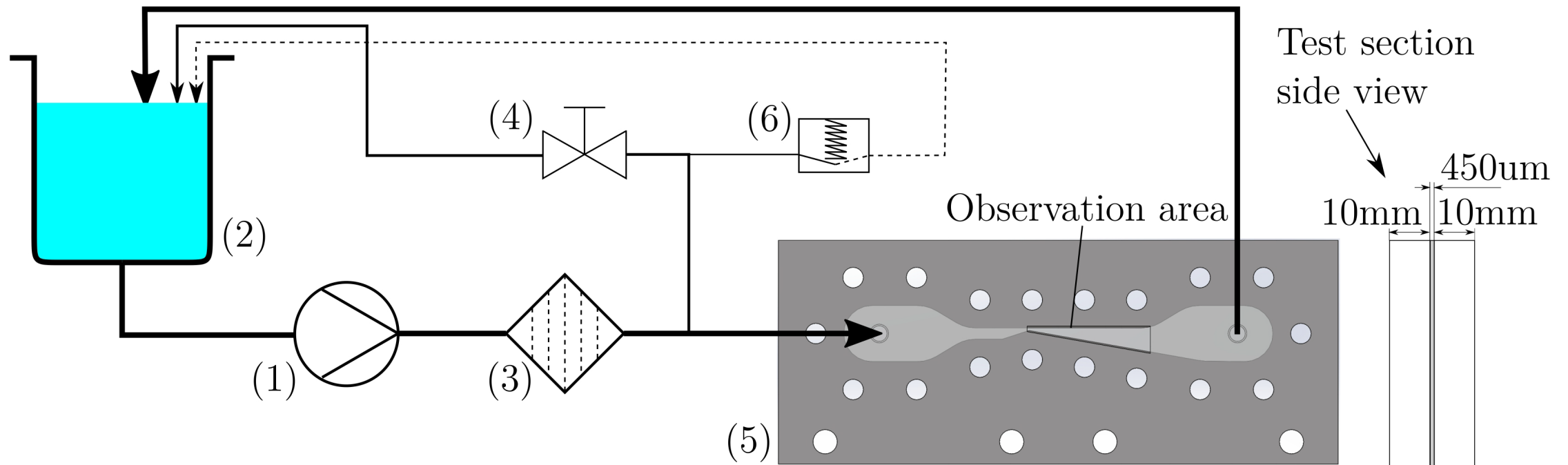

Fig. 13. The importance of individual phenomenon.



Geometry:

- 18°/8° Venturi channel
- Height: 75... 1000 μm
- Width: 45... 750 μm

Conditions:

- $p_{\text{in}} = 2... 12 \text{ bar}$
- $v_{\text{th}} = 20... 70 \text{ m/s}$

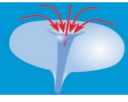

ERC (2018 –)

Argonne 
NATIONAL LABORATORY



Argonne
NATIONAL LABORATORY

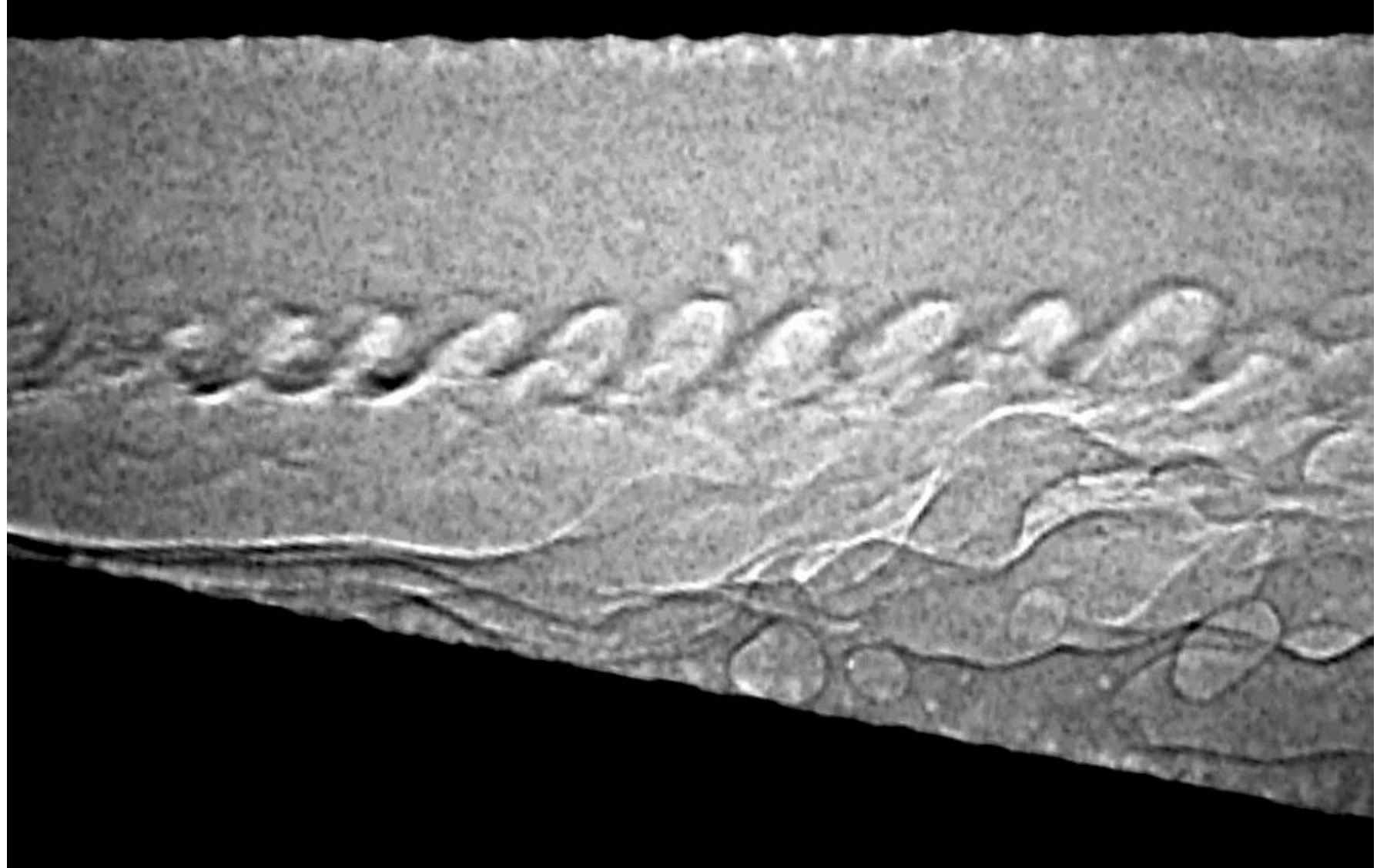



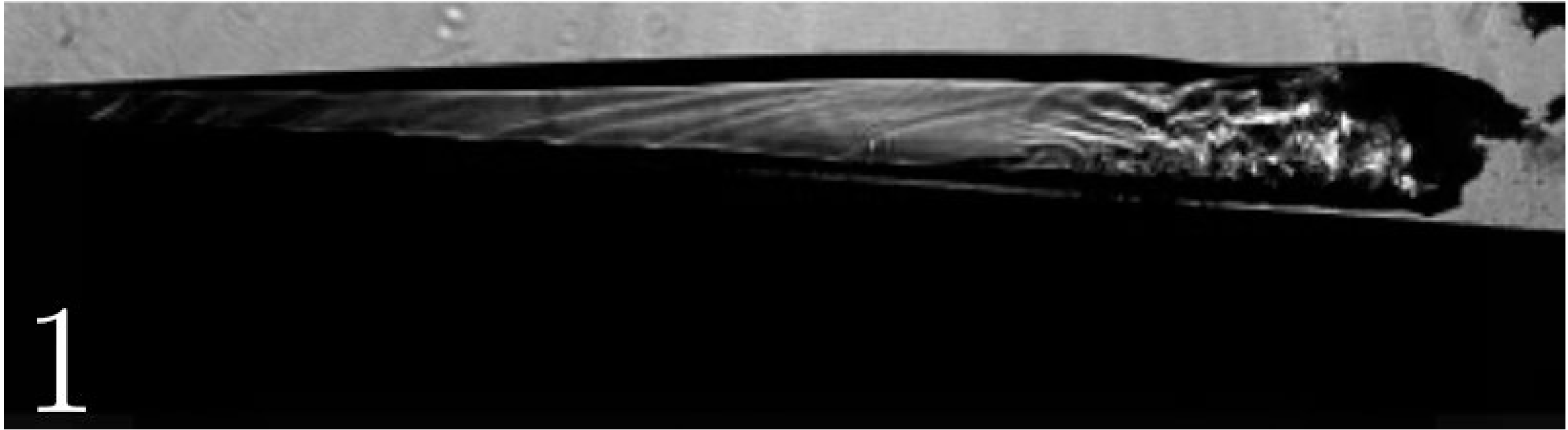

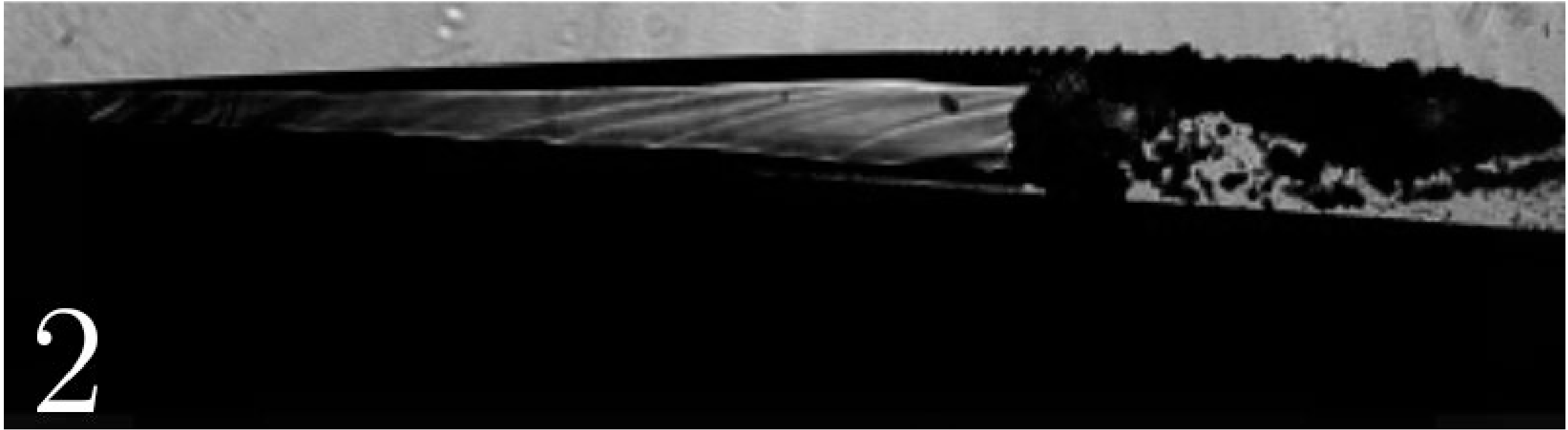

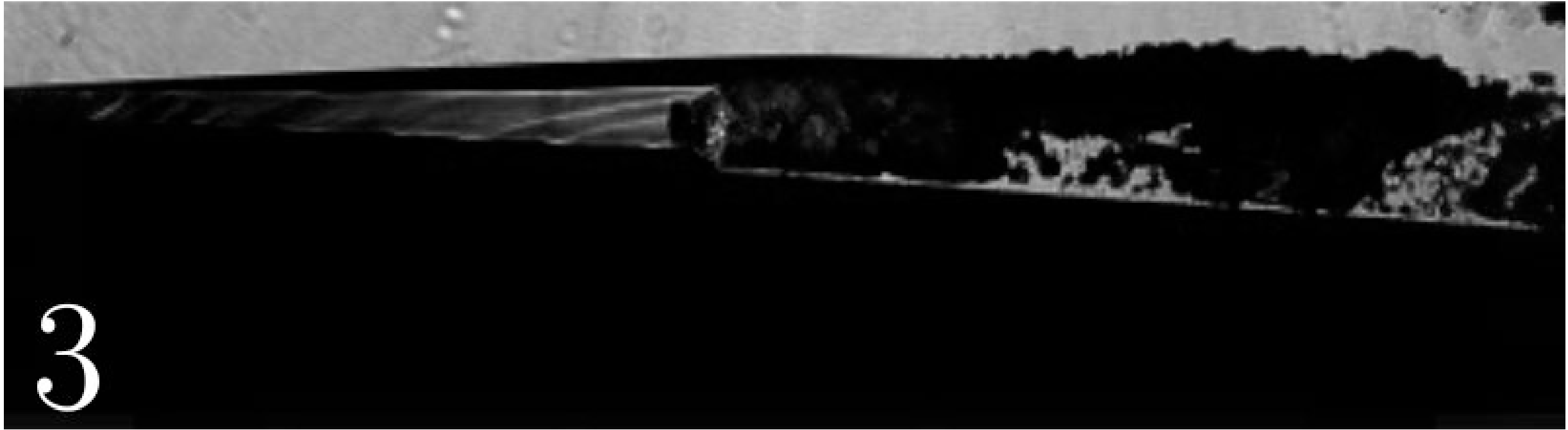

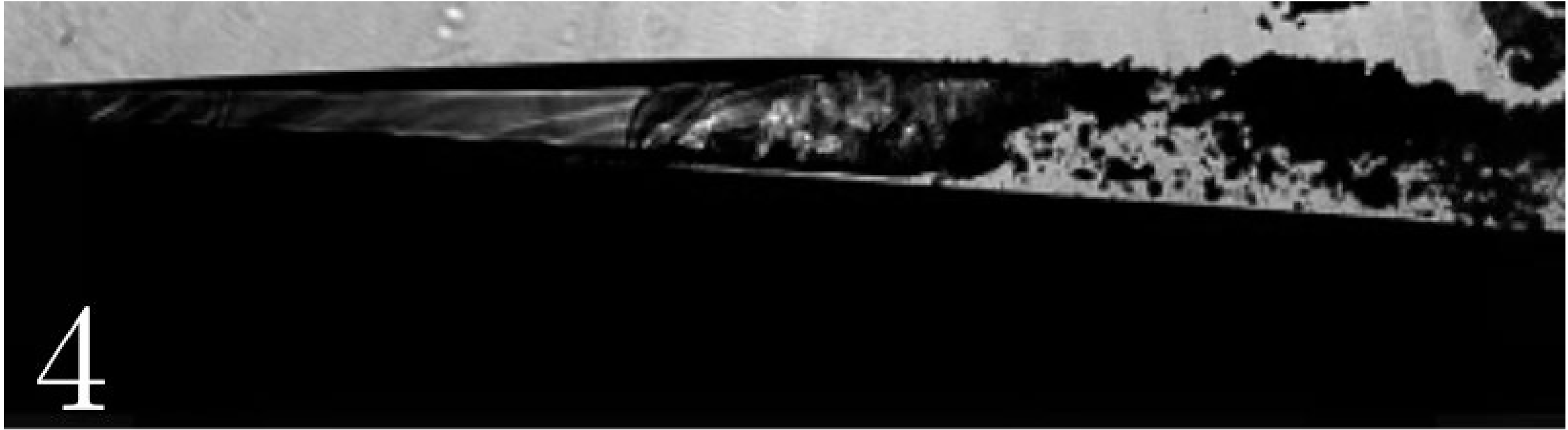

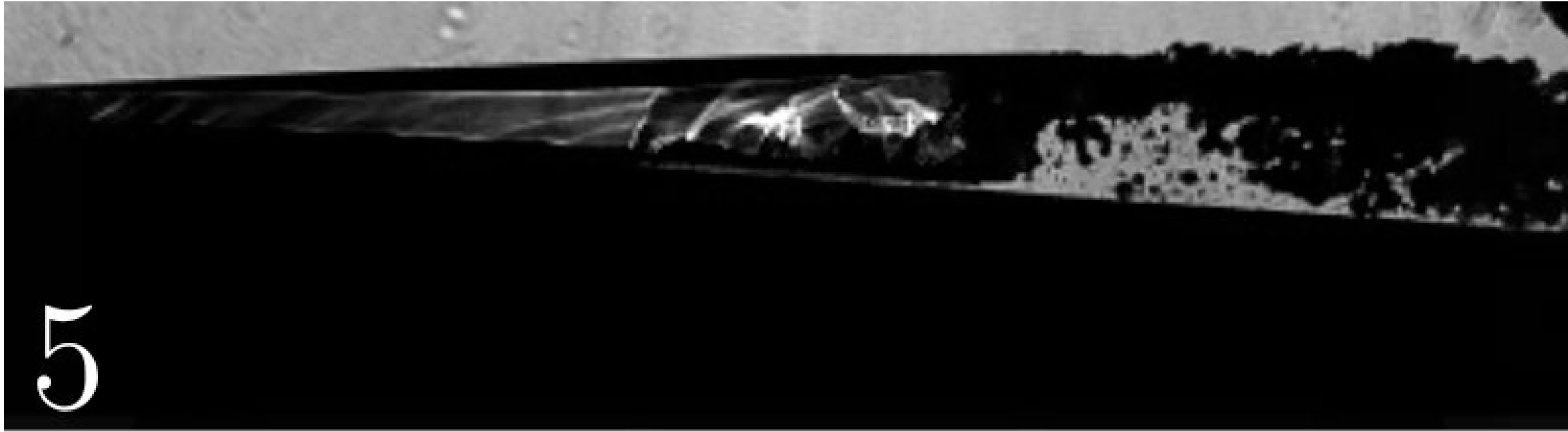

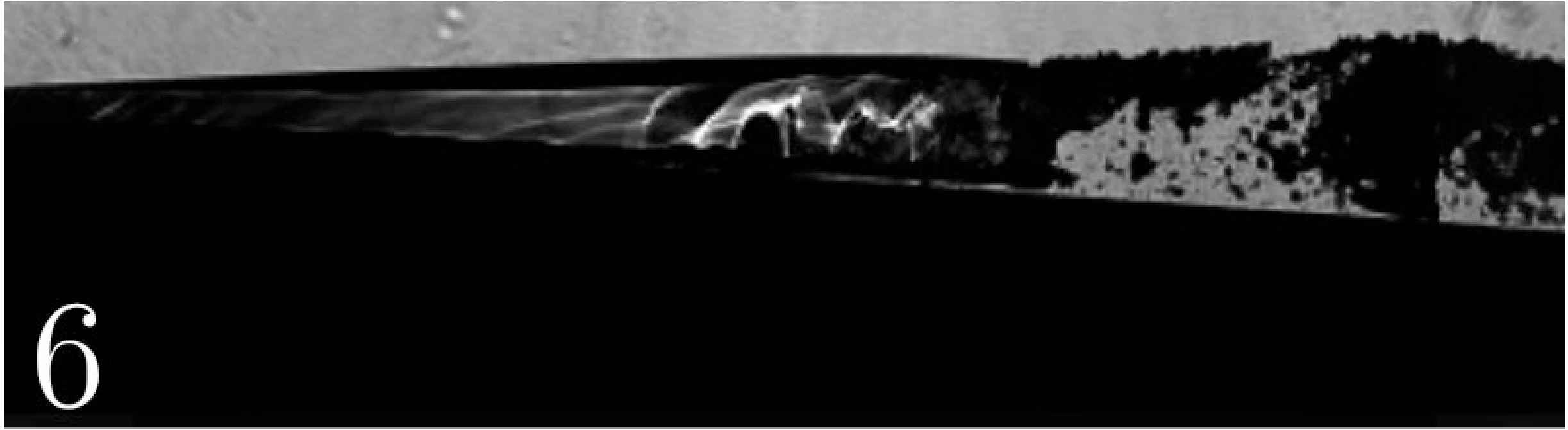

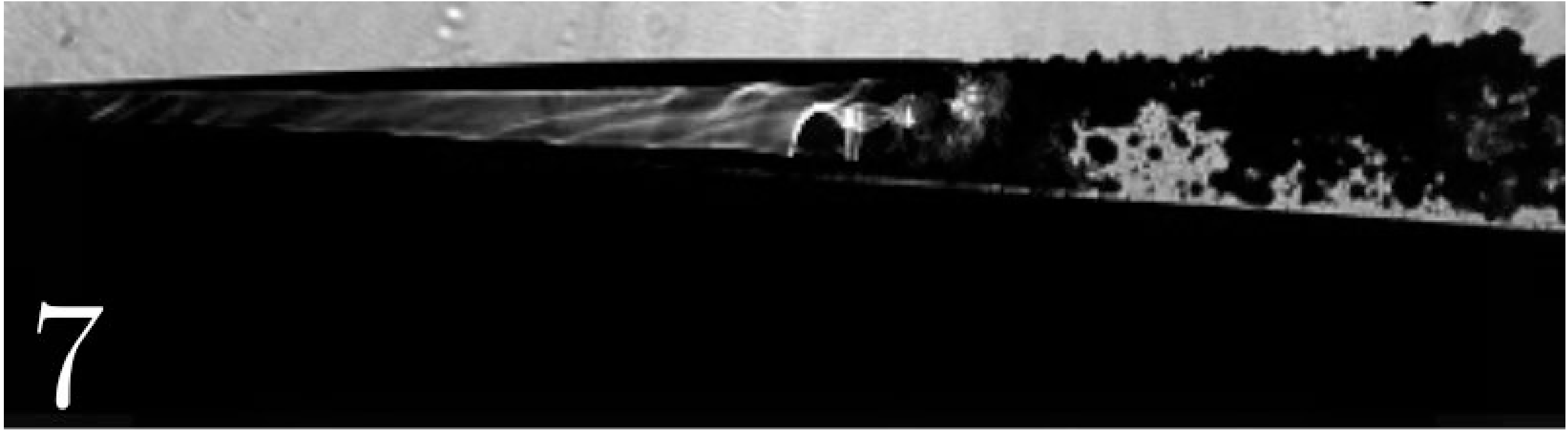

7

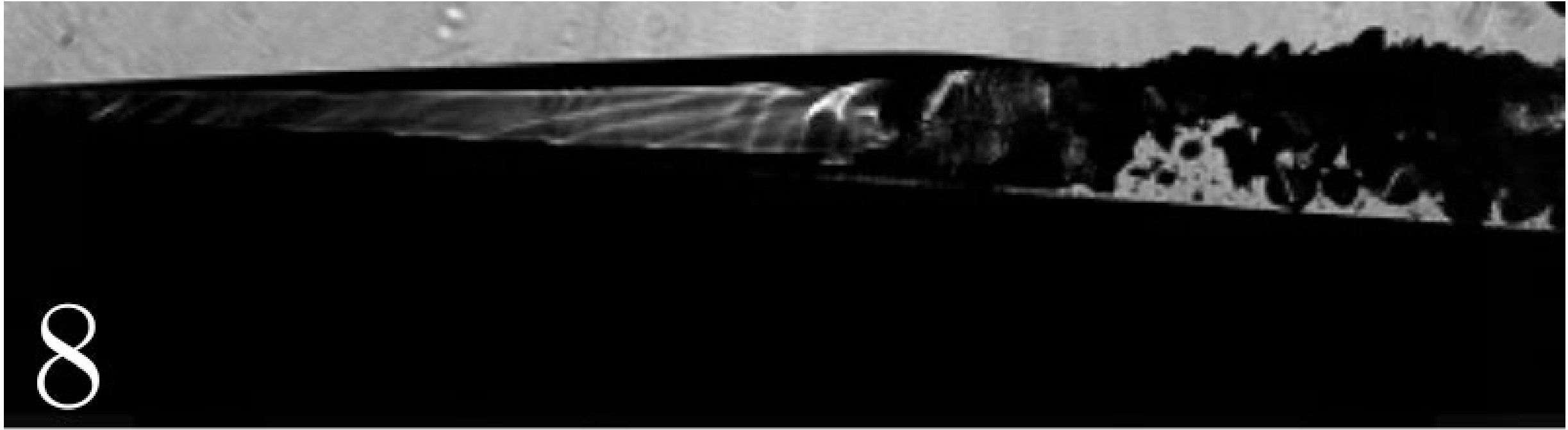

8

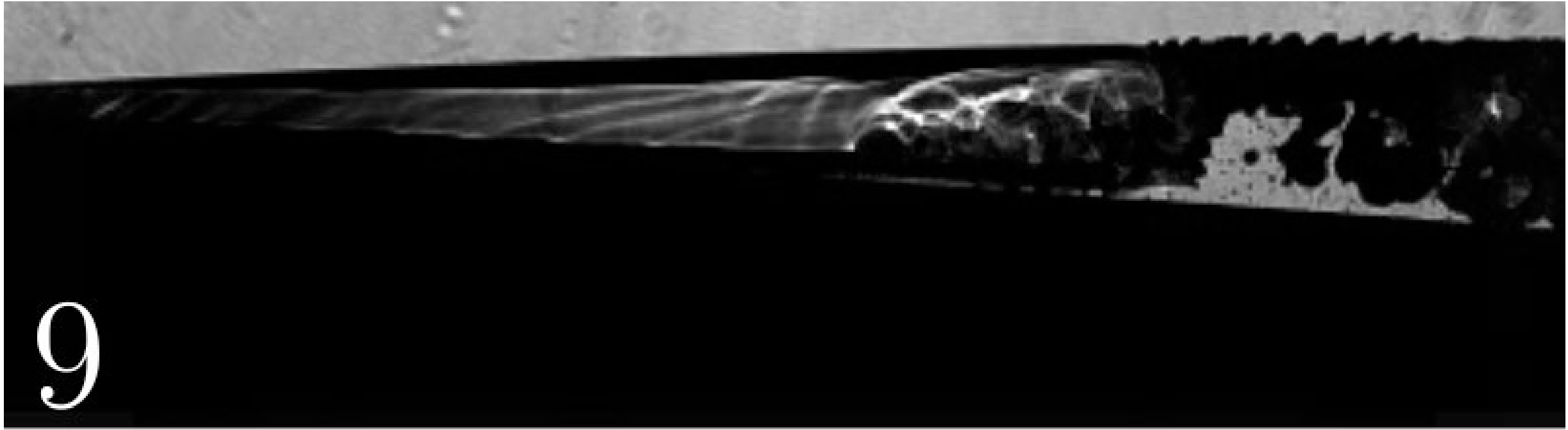

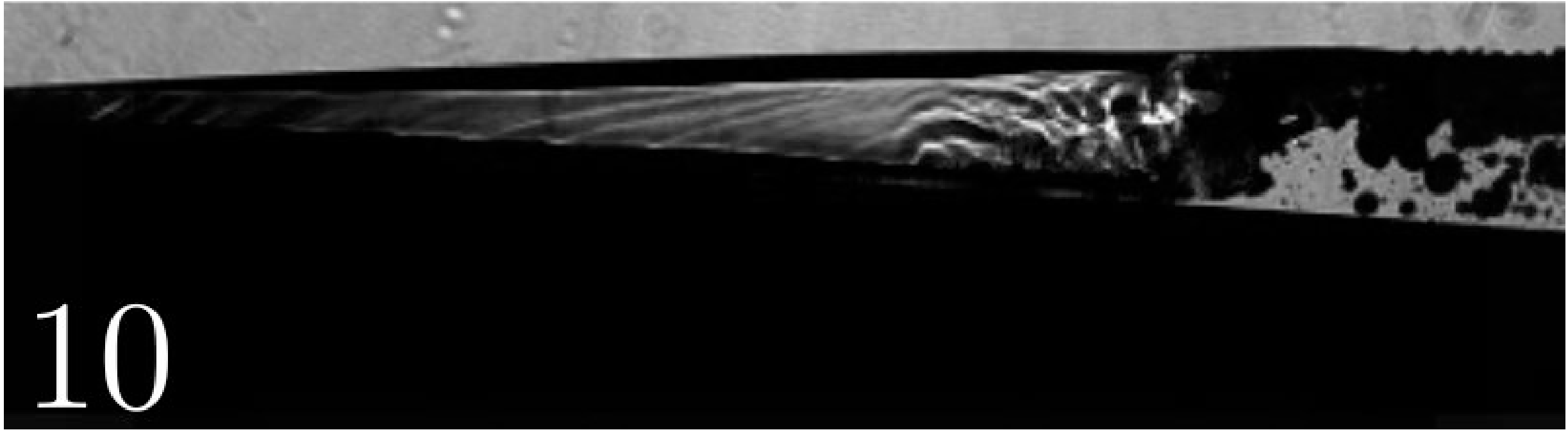

10

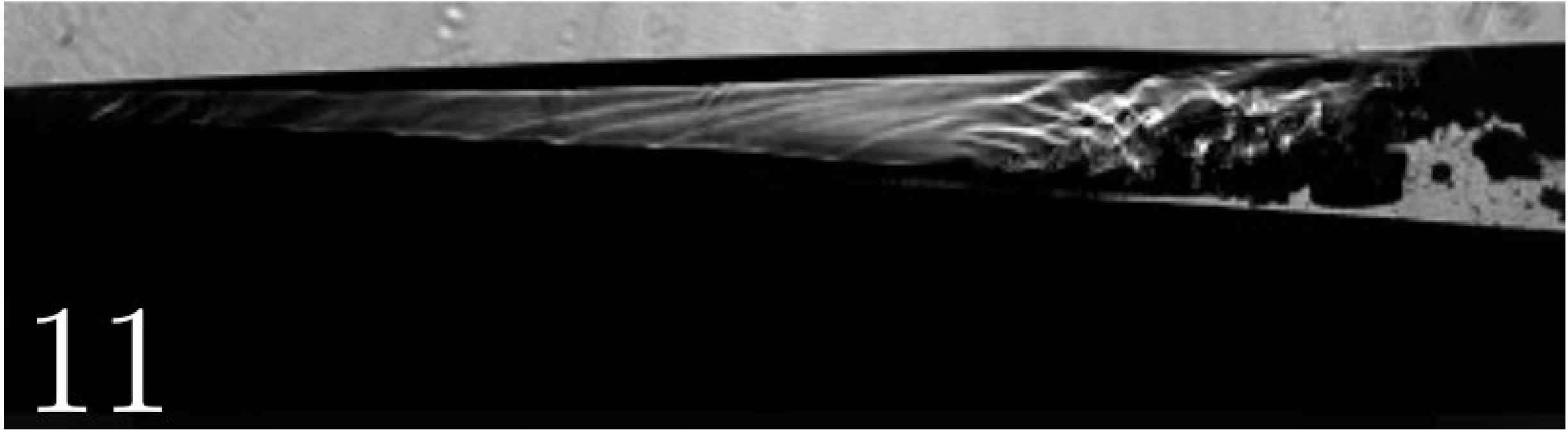

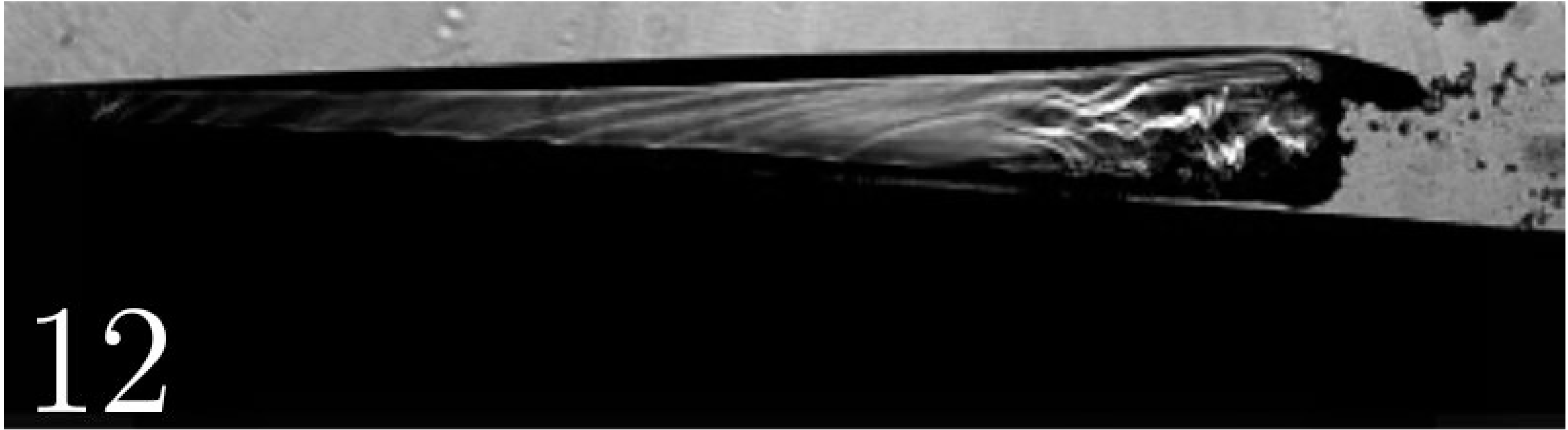

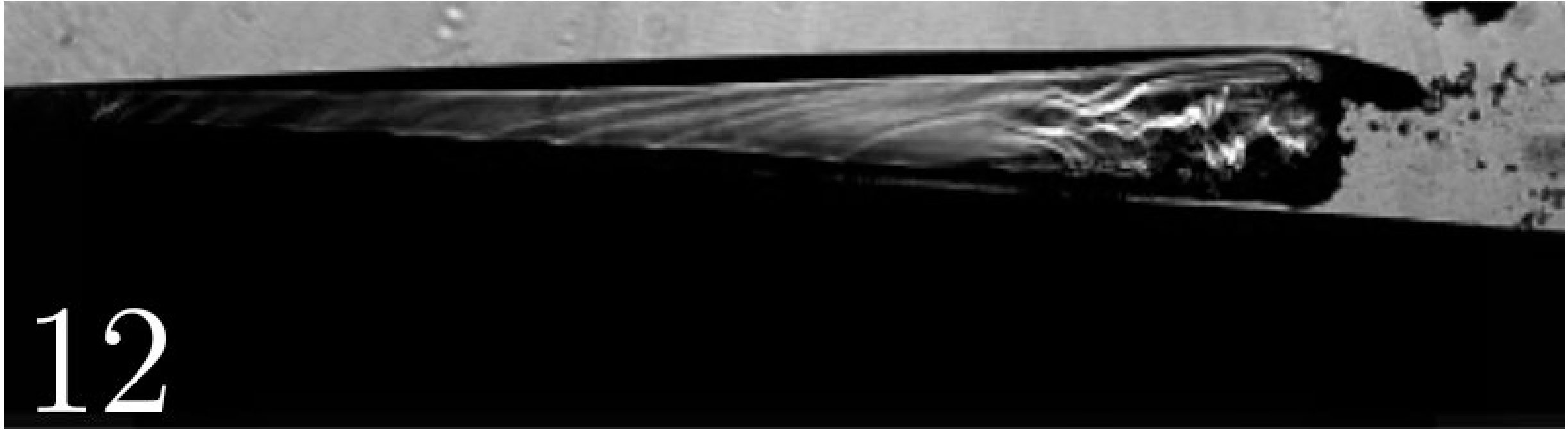

12

Argonne 
NATIONAL LABORATORY



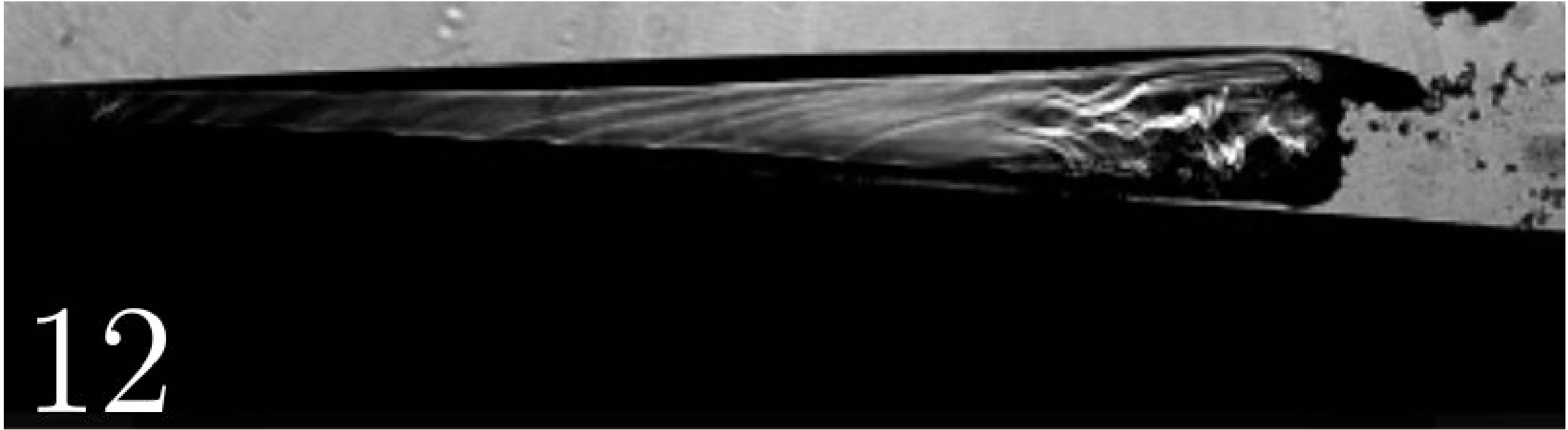

Argonne 
NATIONAL LABORATORY

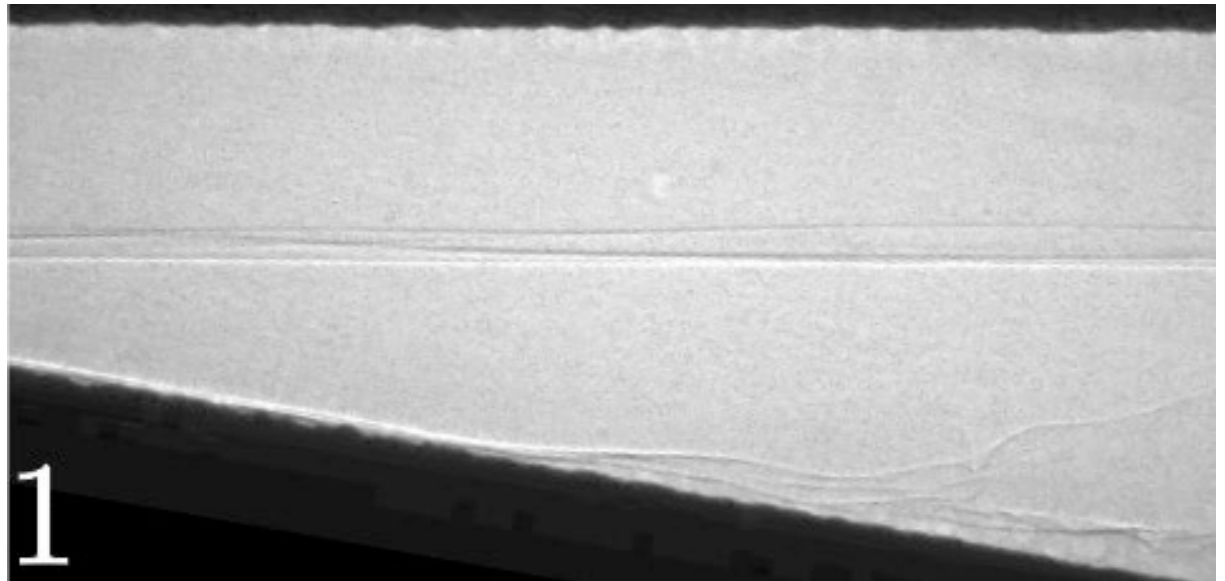

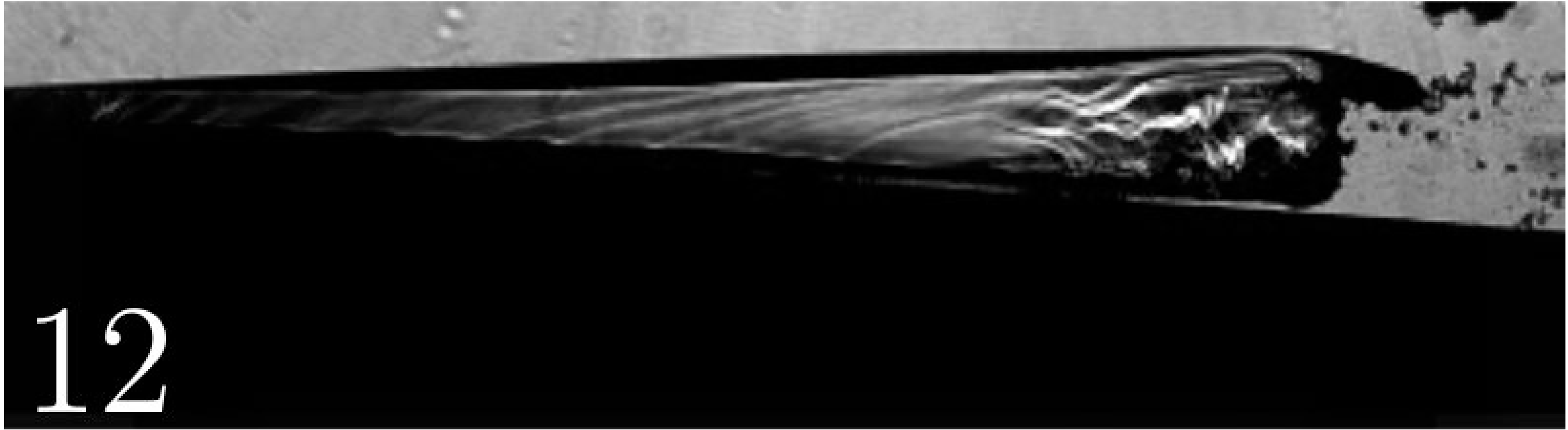

Argonne 
NATIONAL LABORATORY

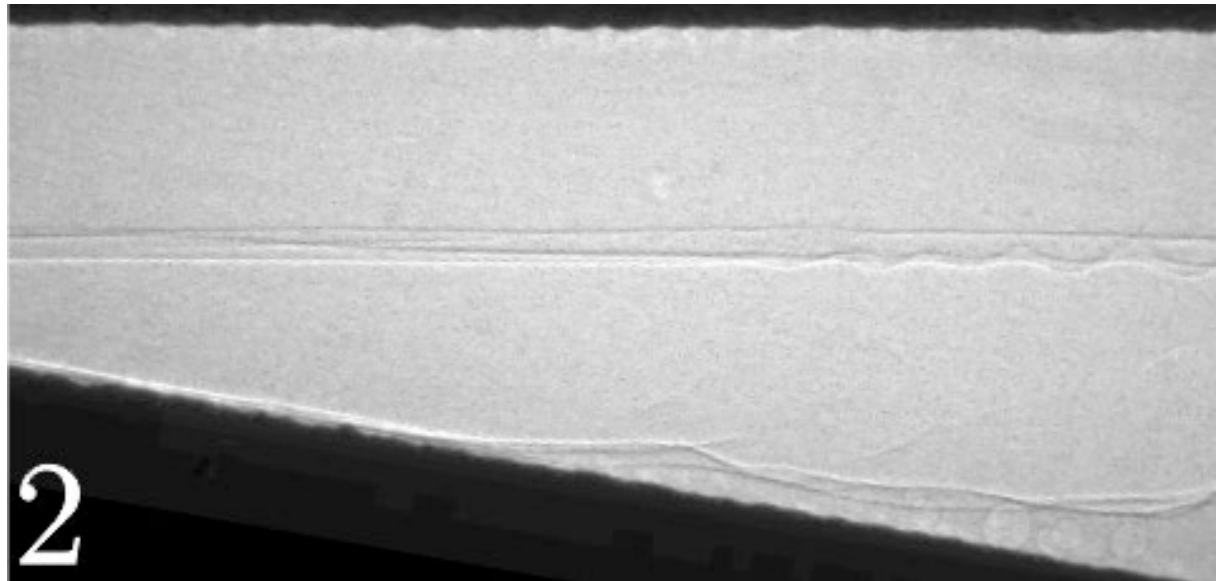

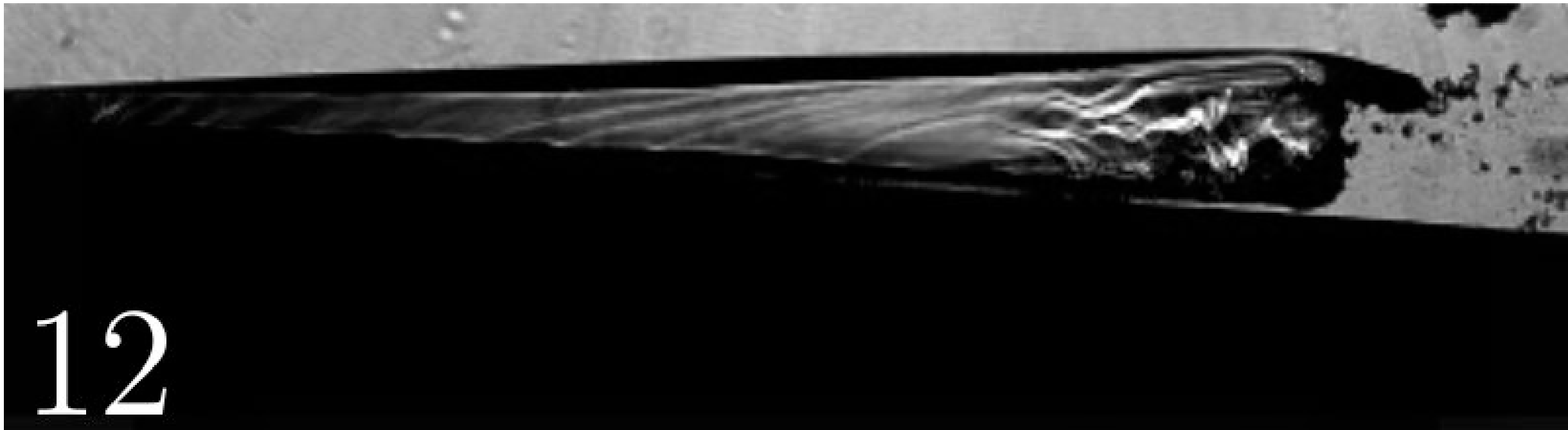

Argonne 
NATIONAL LABORATORY

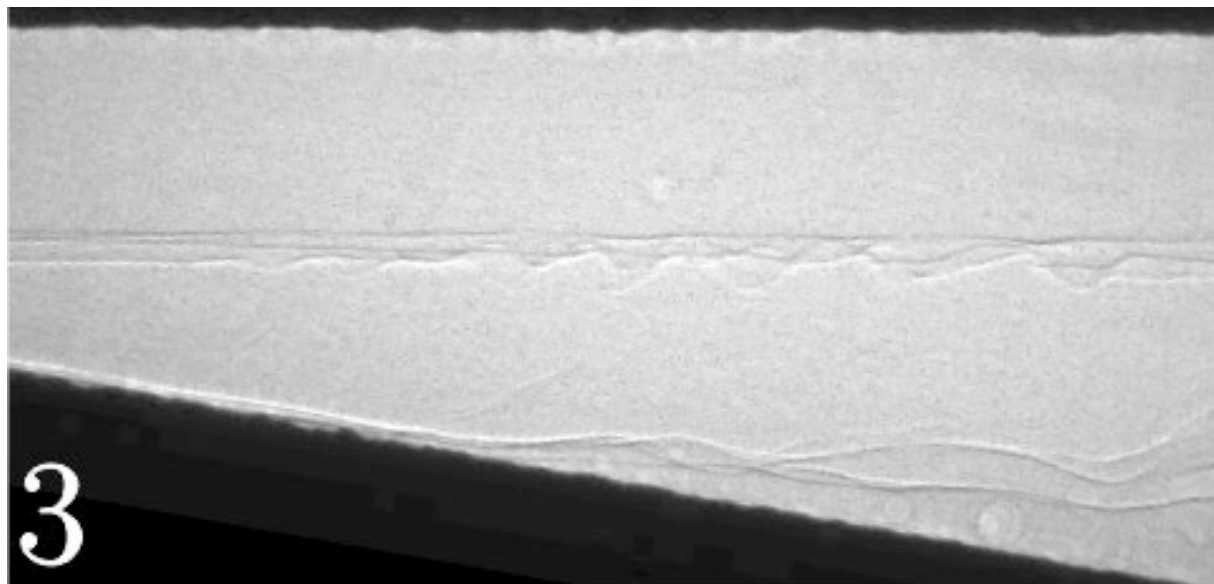

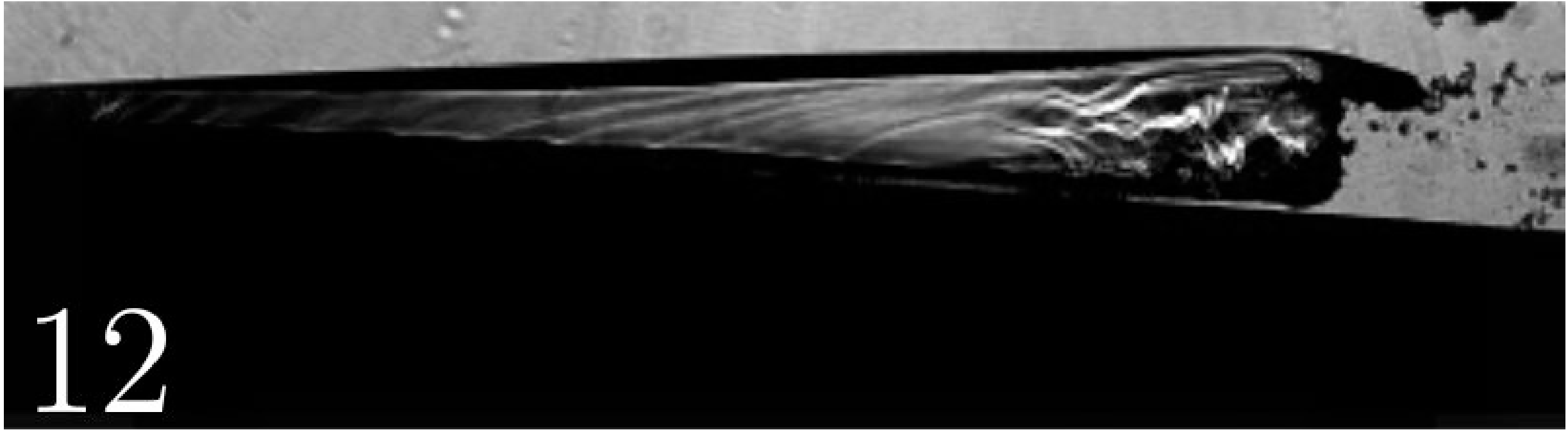

Argonne 
NATIONAL LABORATORY

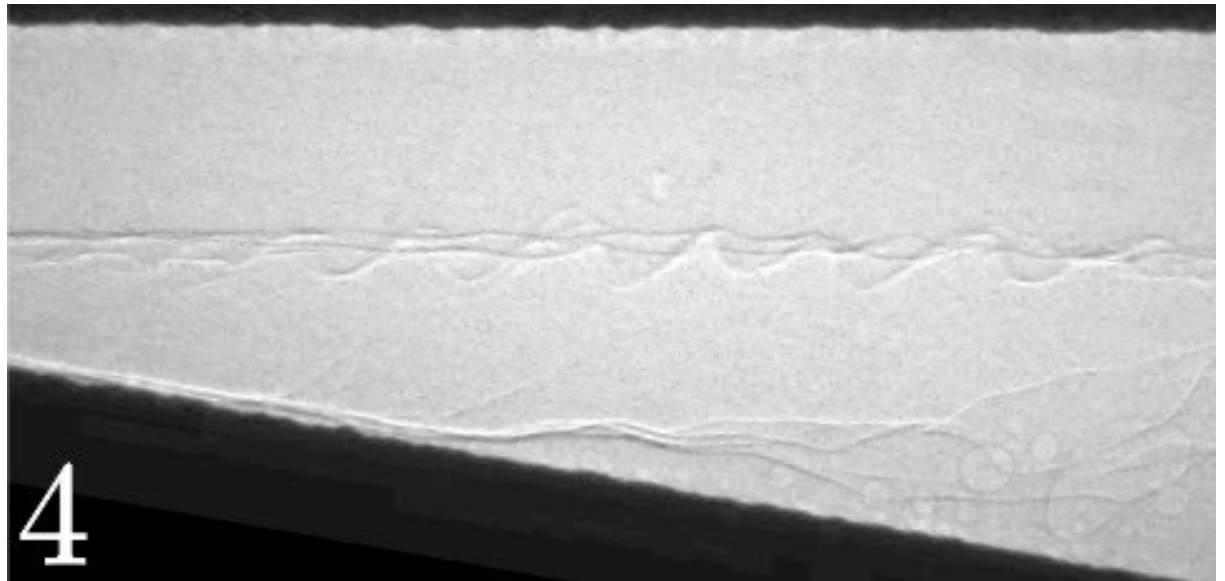

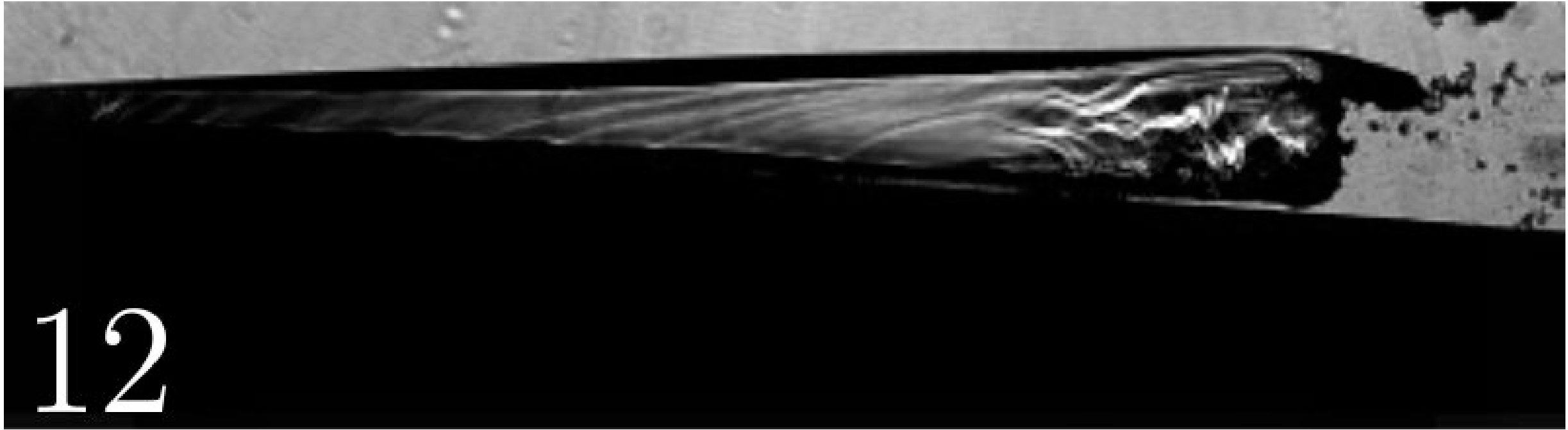

Argonne 
NATIONAL LABORATORY

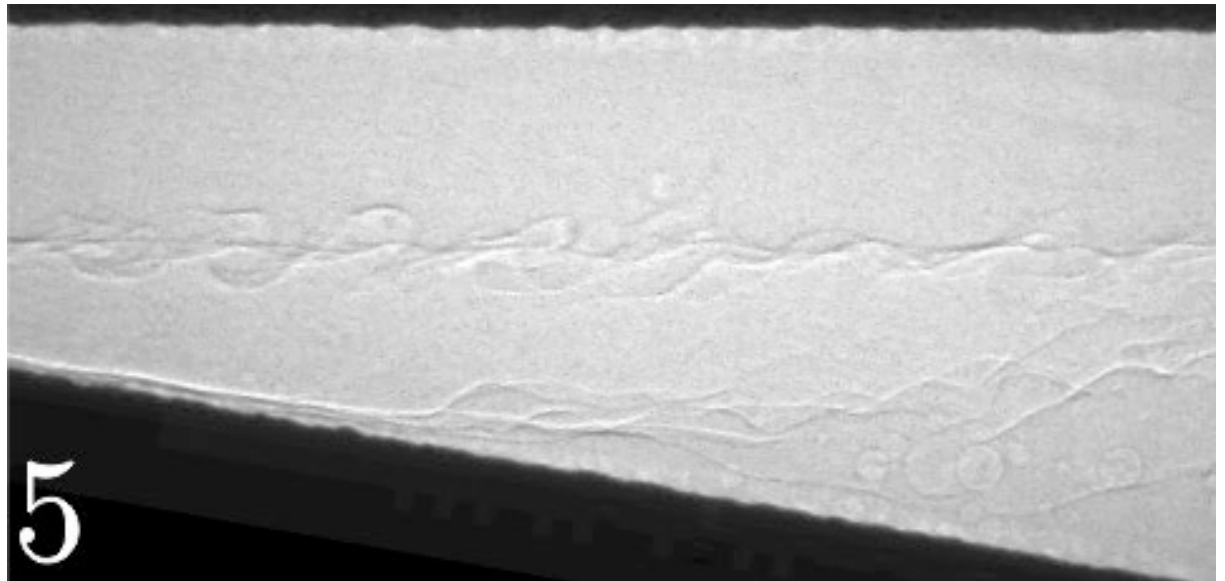

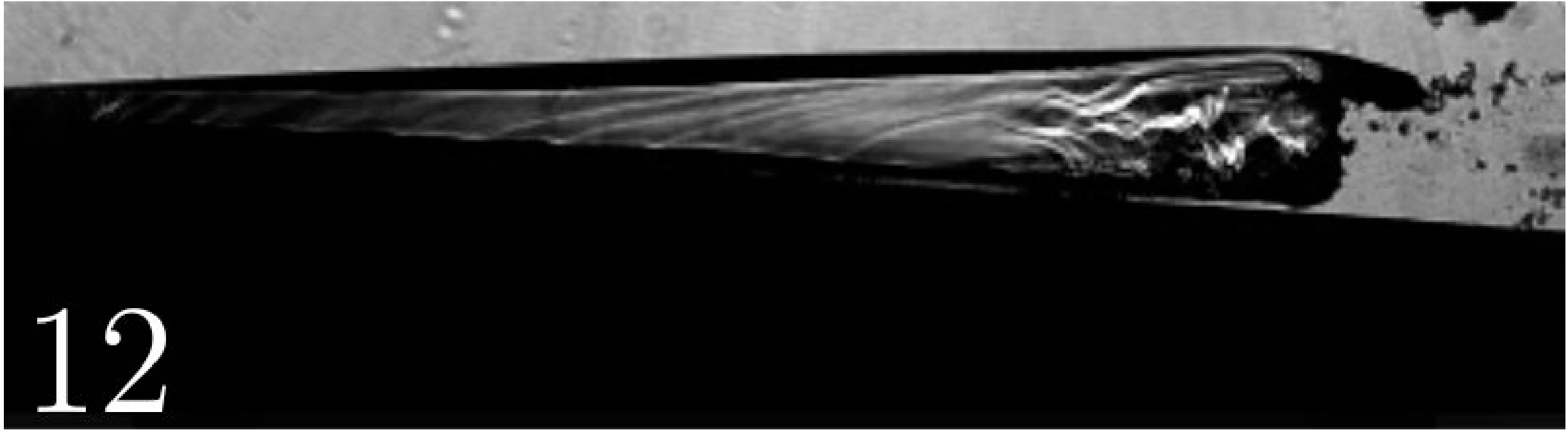

Argonne 
NATIONAL LABORATORY

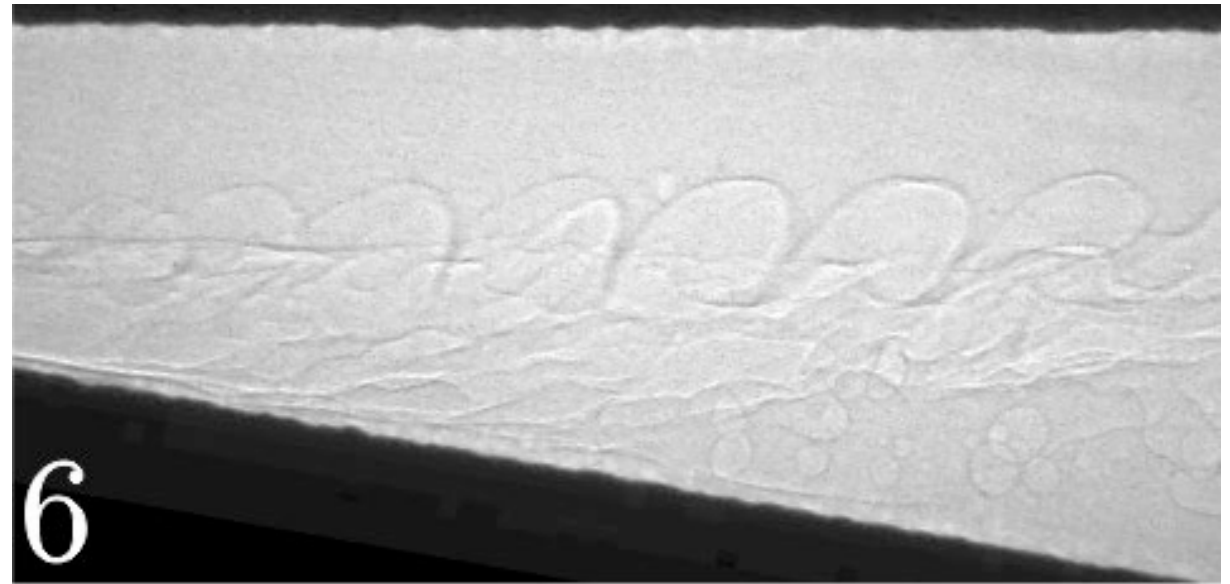

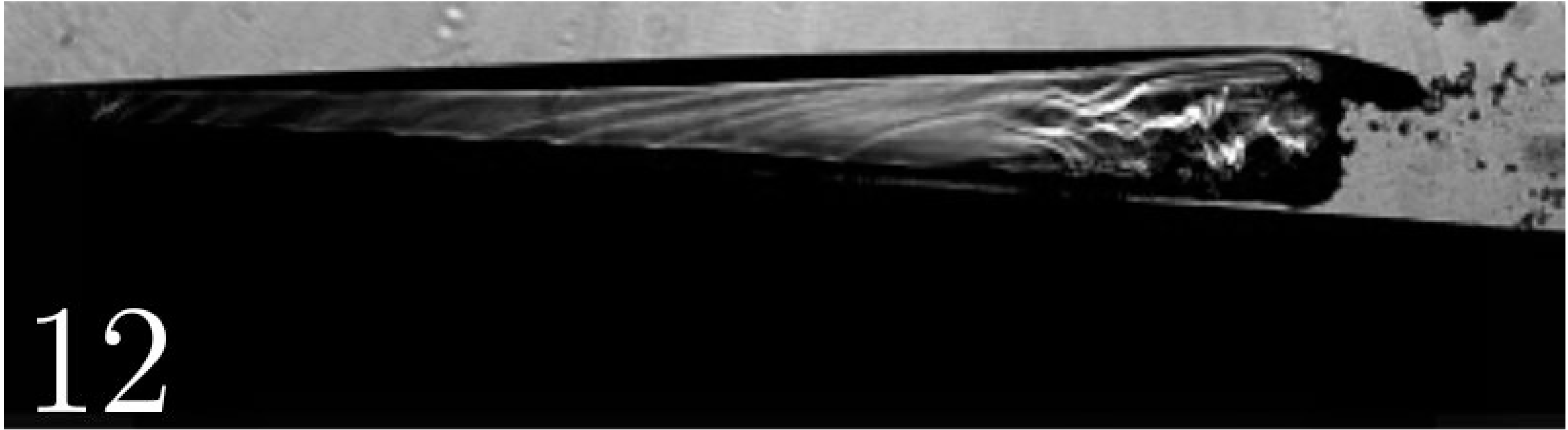

Argonne 
NATIONAL LABORATORY

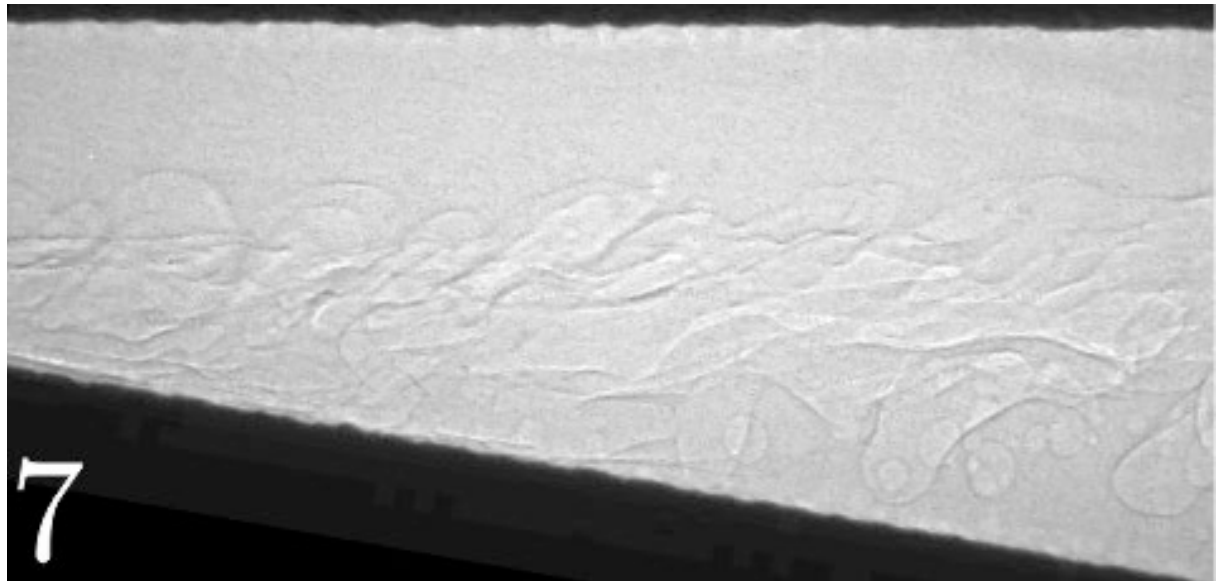

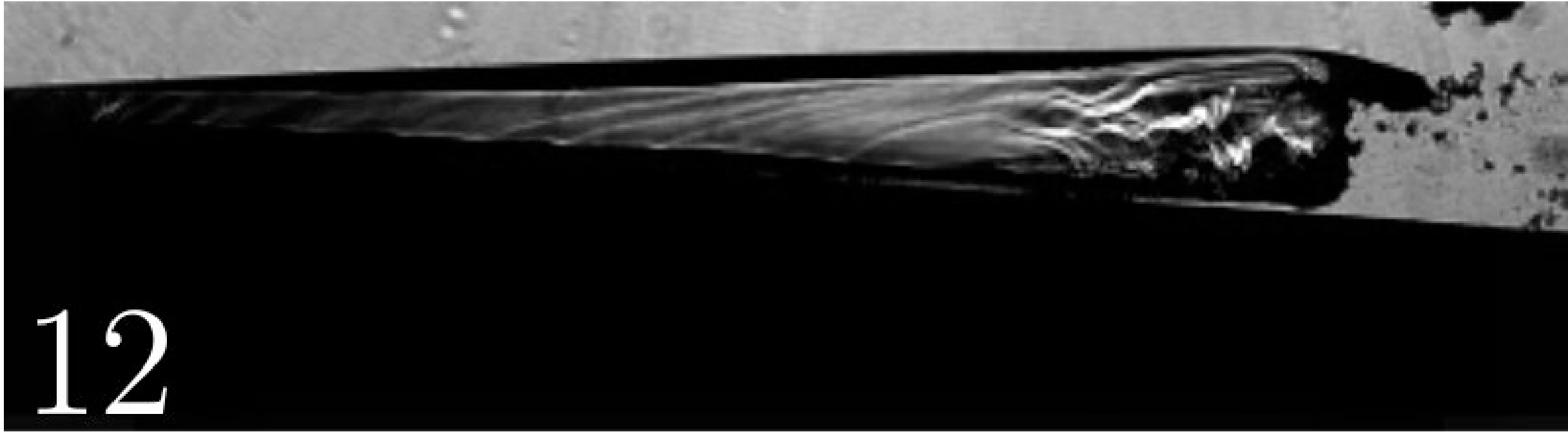

Argonne 
NATIONAL LABORATORY

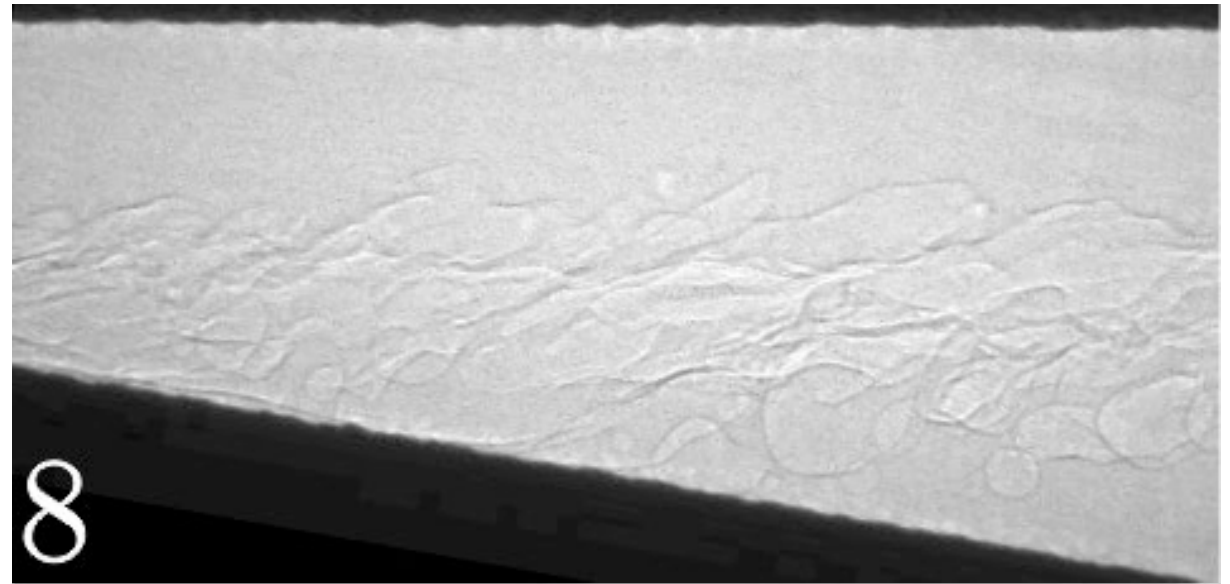

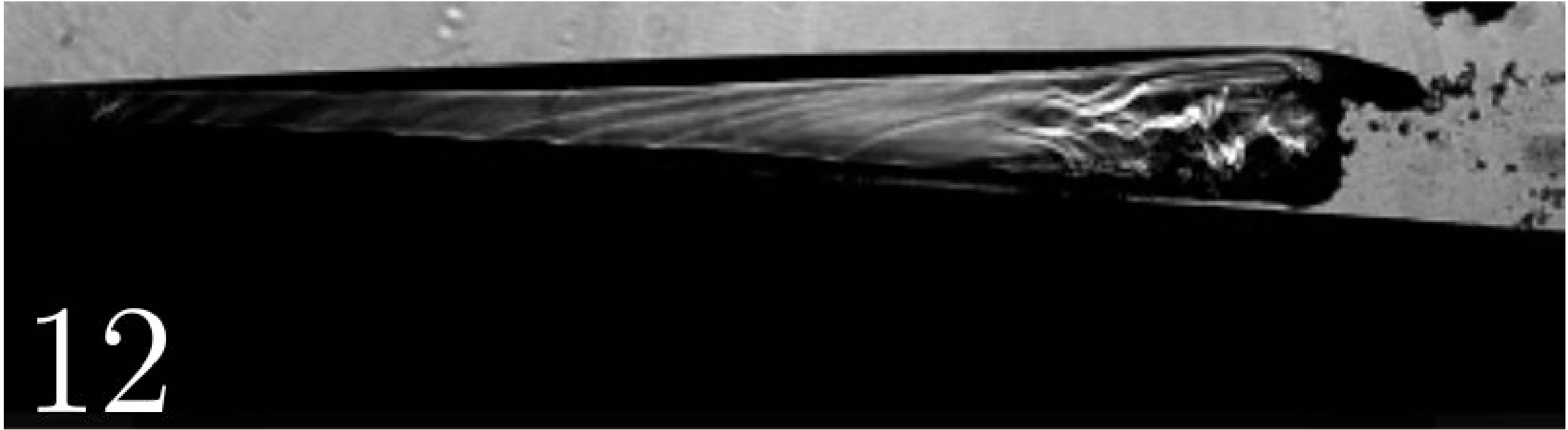

Argonne 
NATIONAL LABORATORY

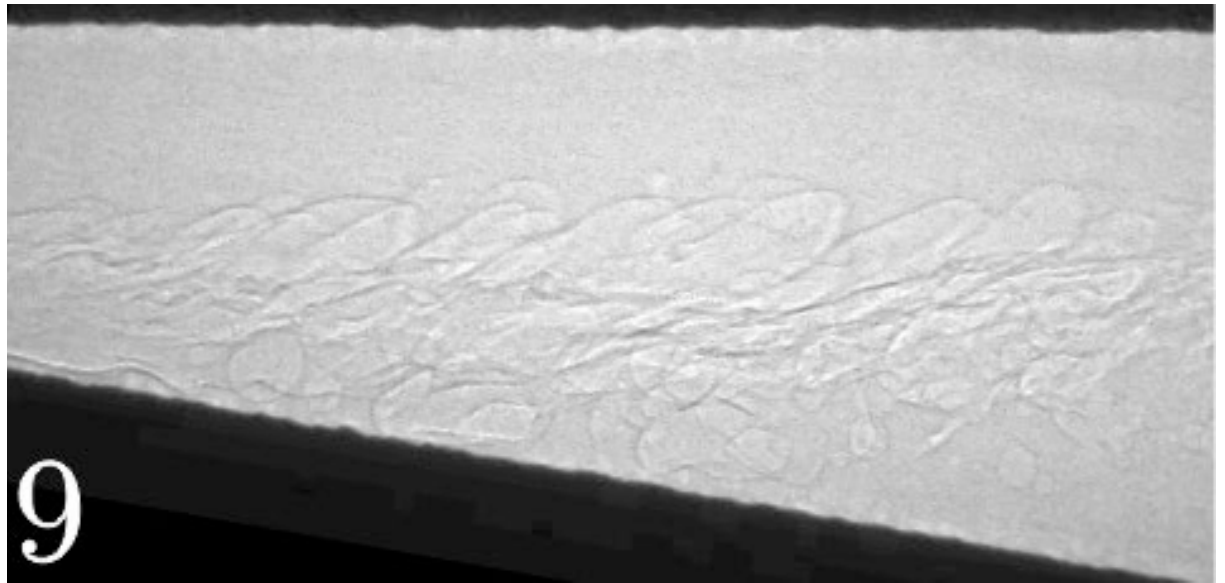

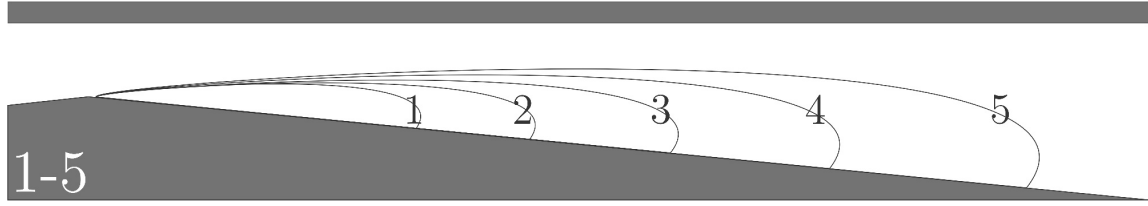

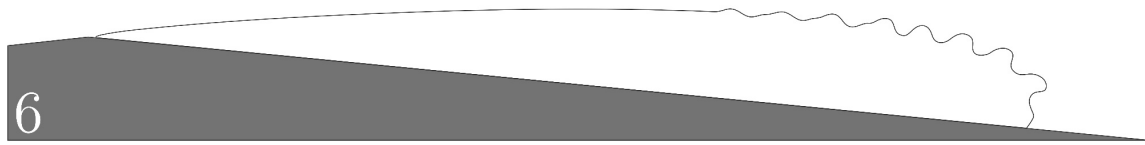
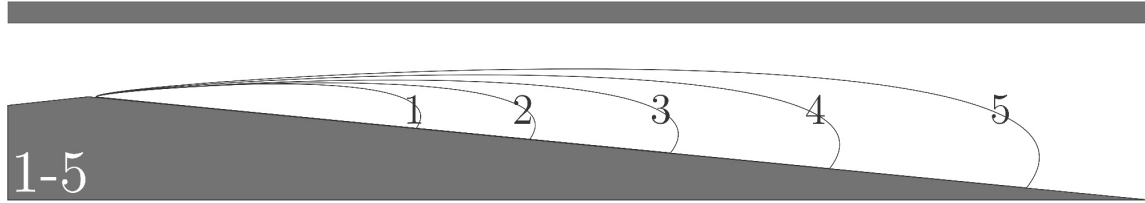
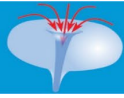

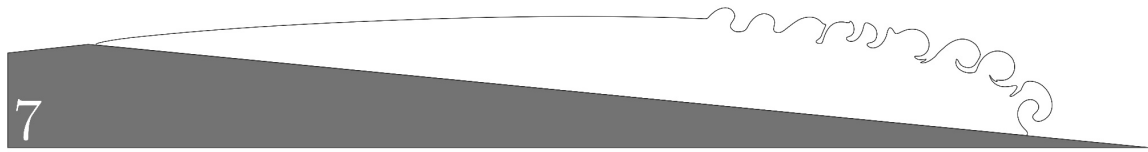
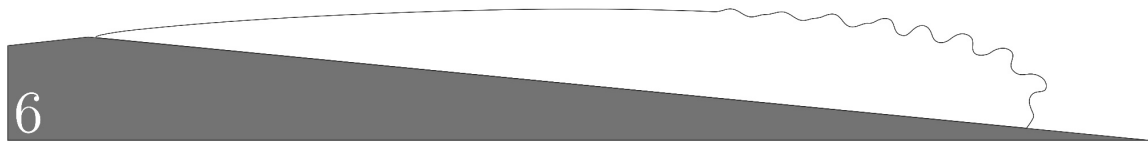
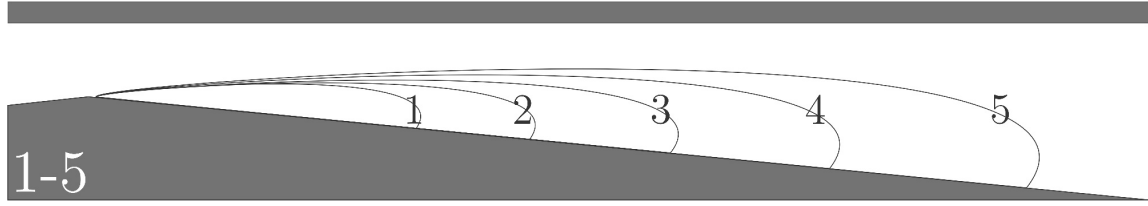
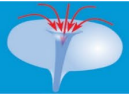

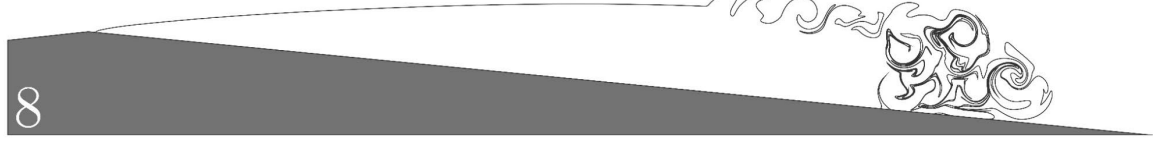
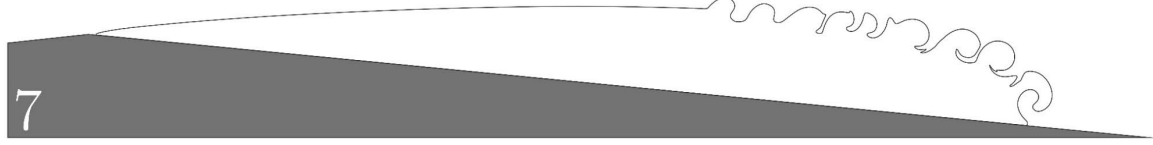
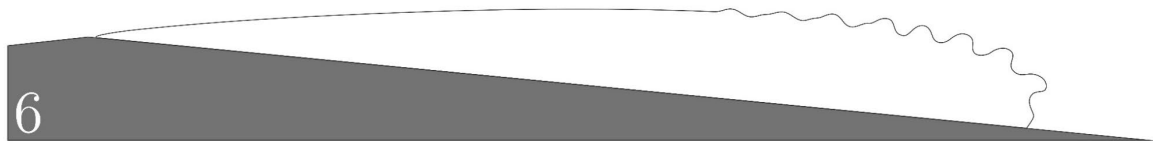
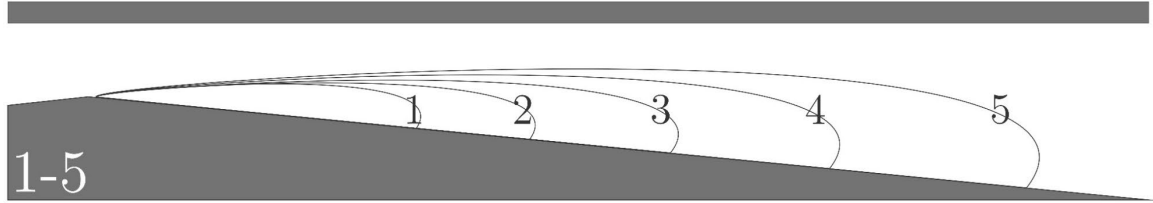

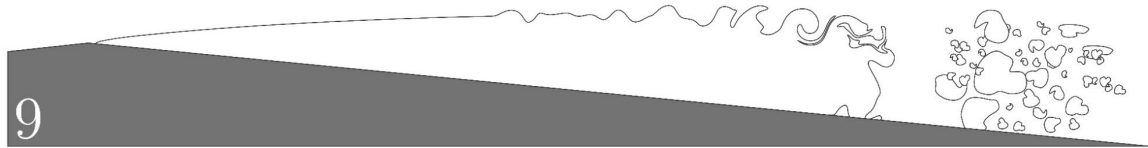
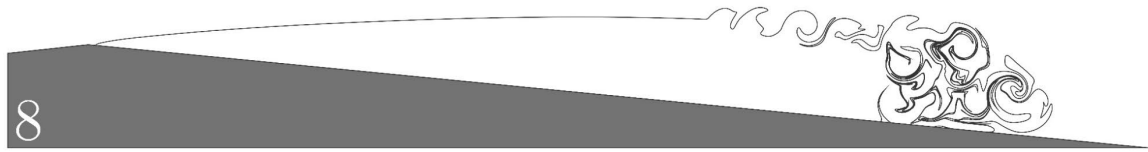
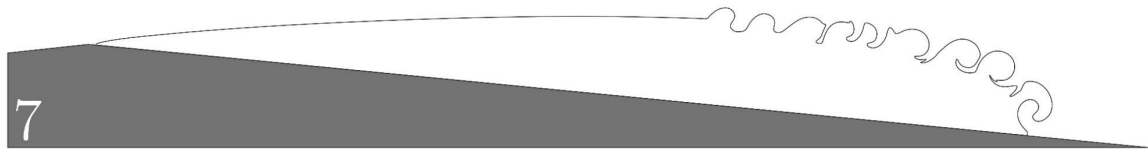
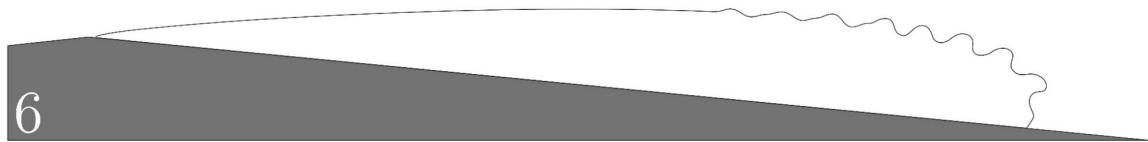
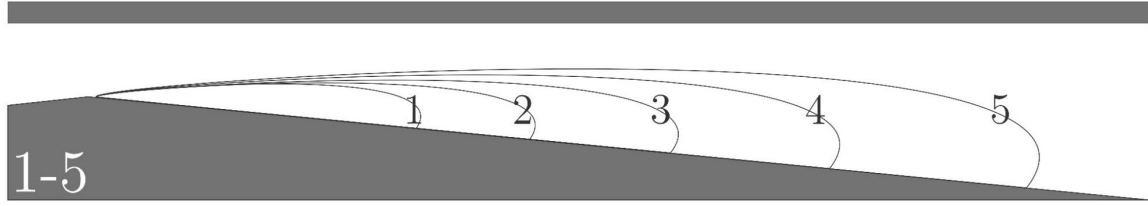
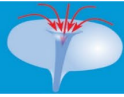

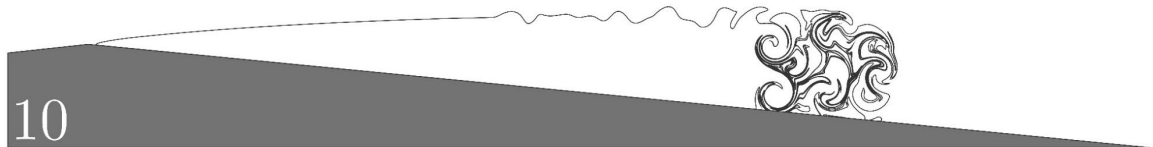
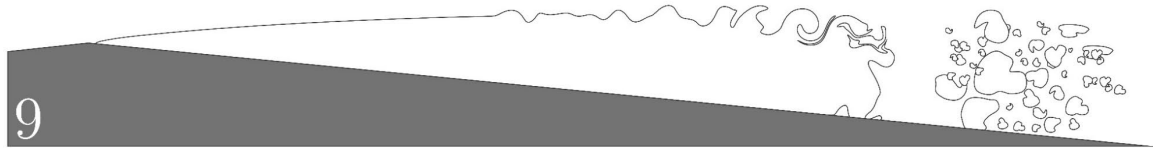
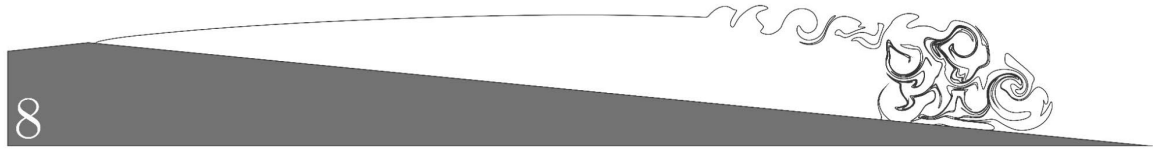
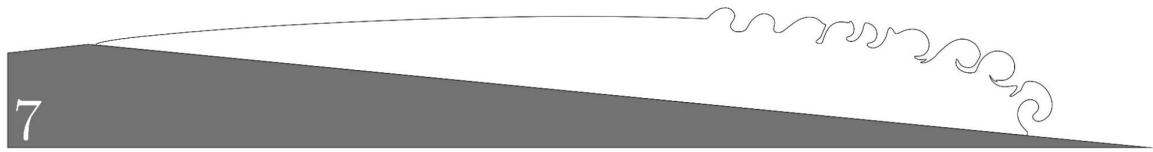
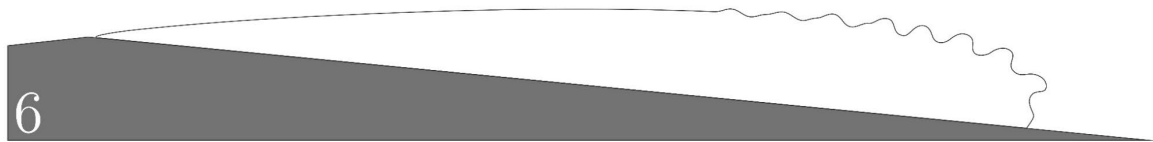
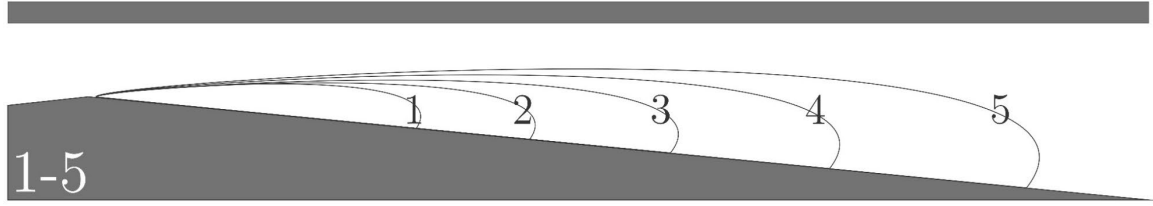
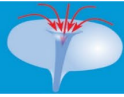

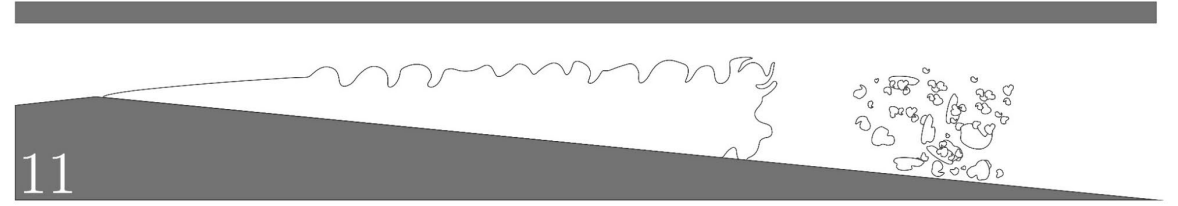
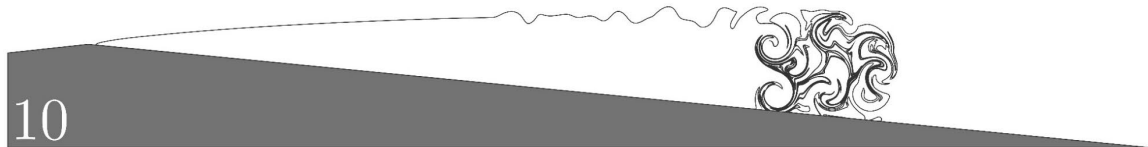
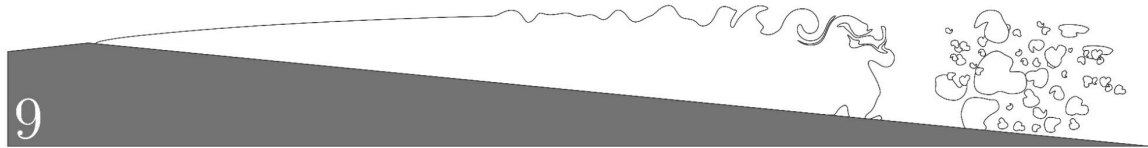
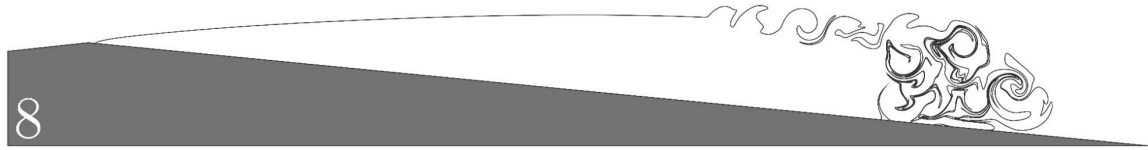
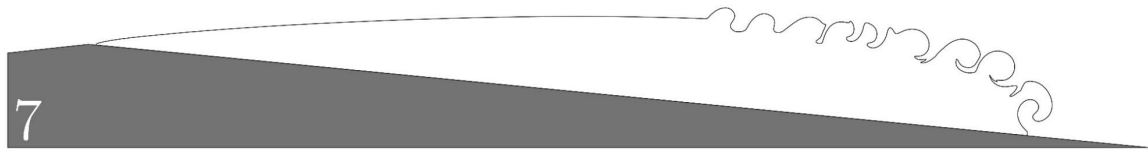
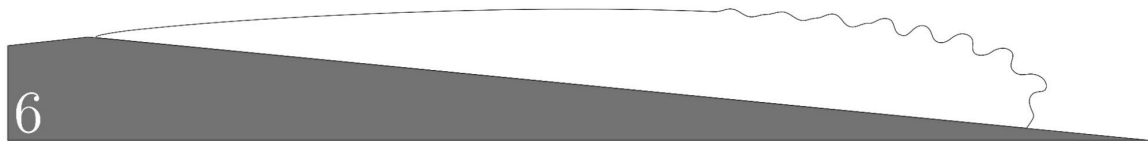
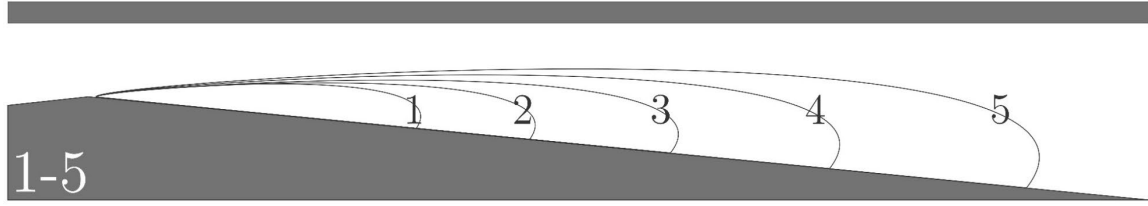
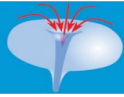

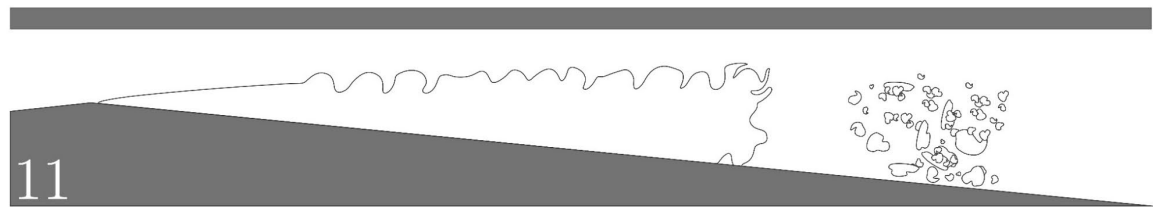
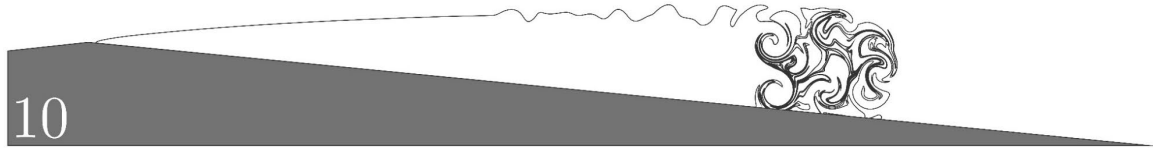
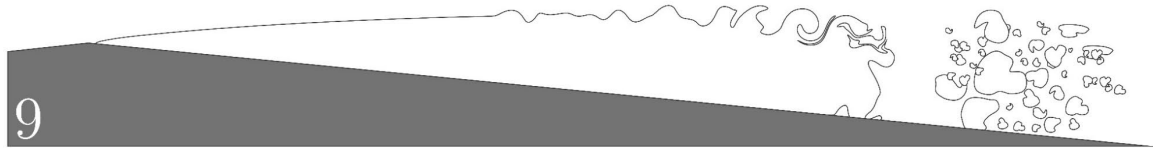
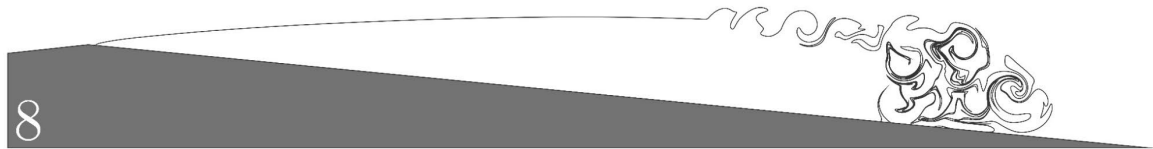
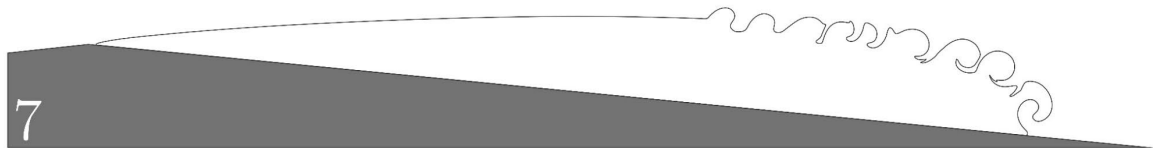
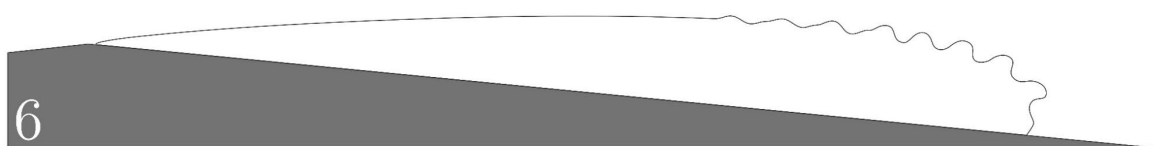
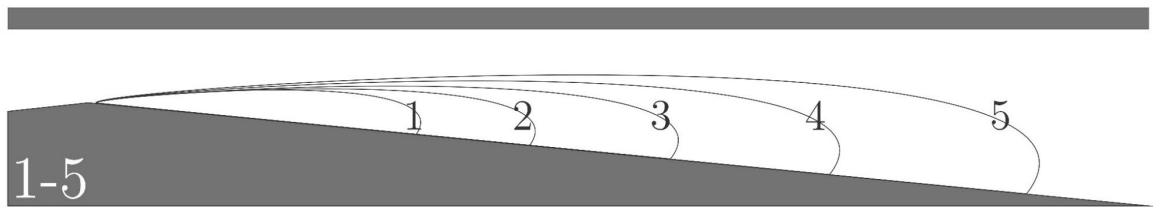
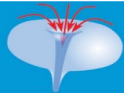

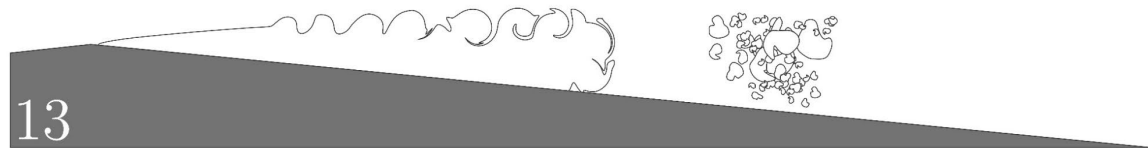
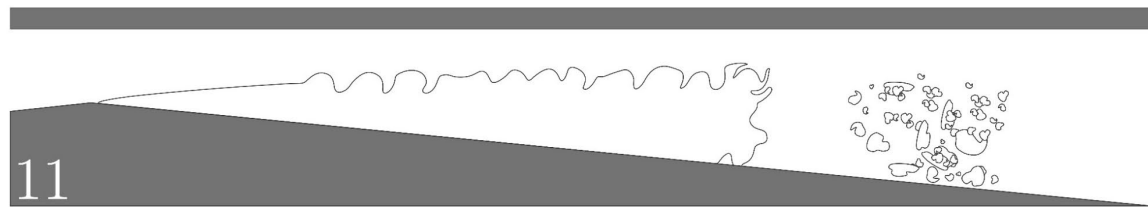
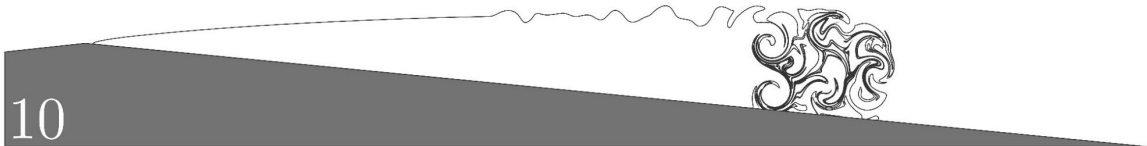
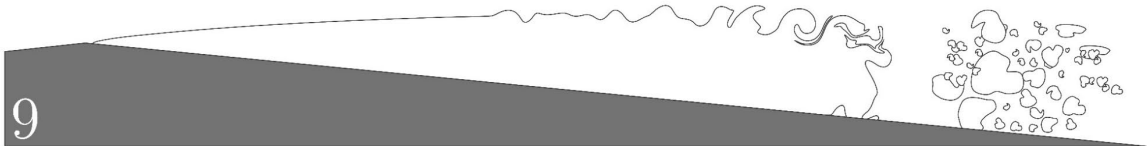
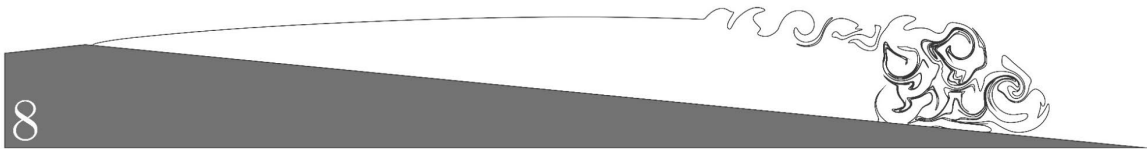
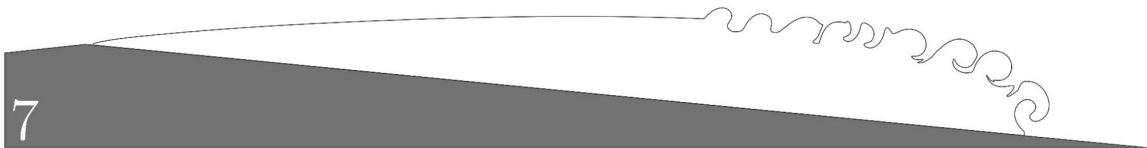
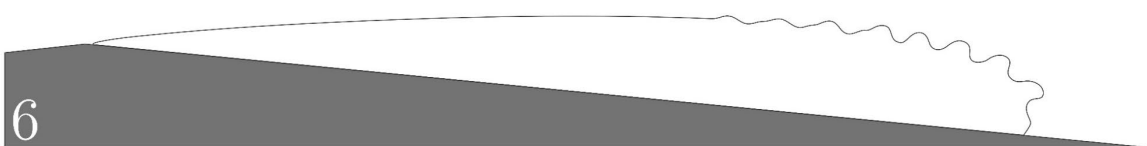
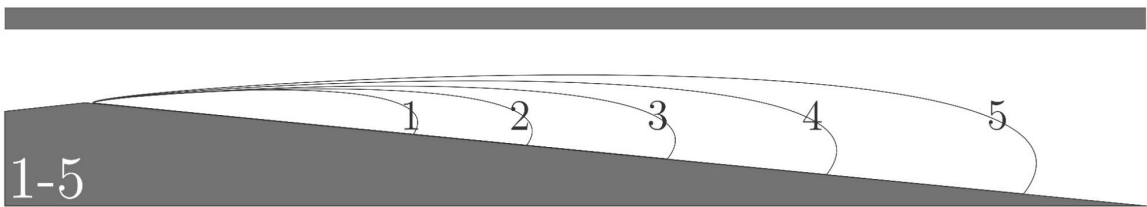

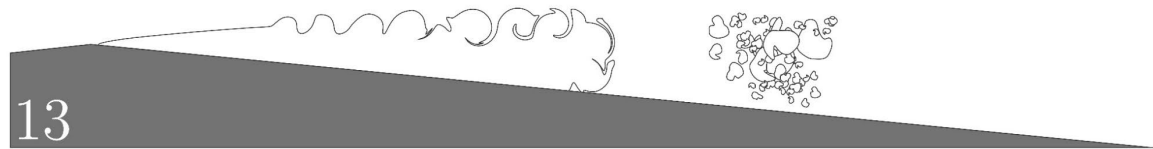
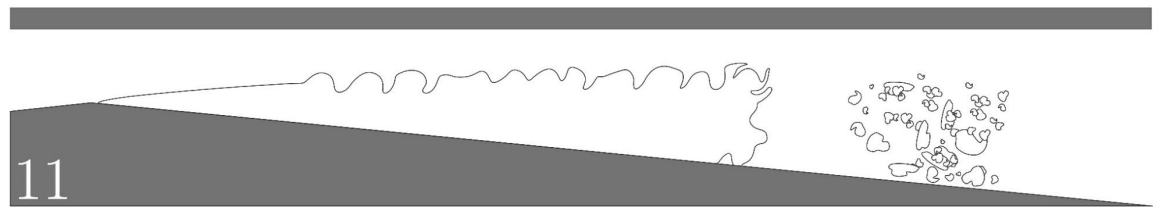
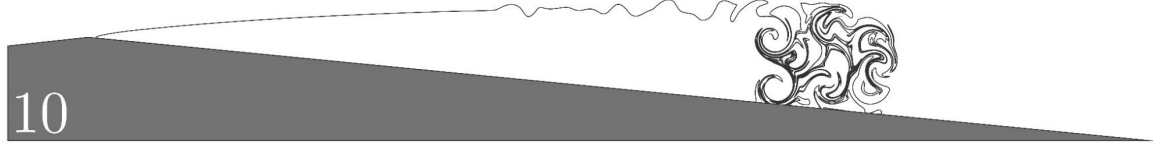
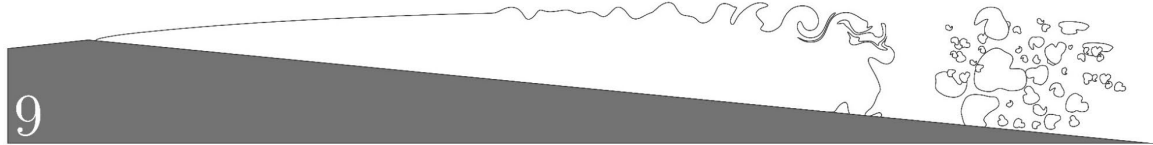
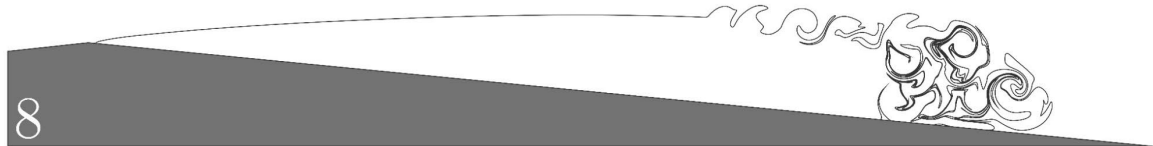
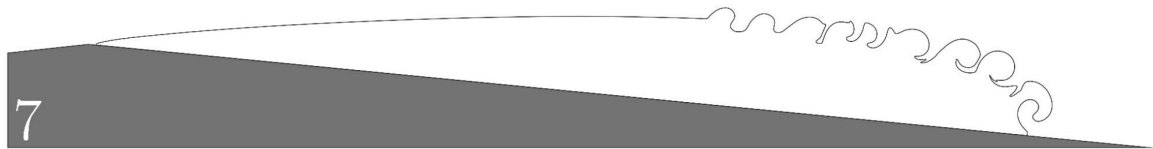
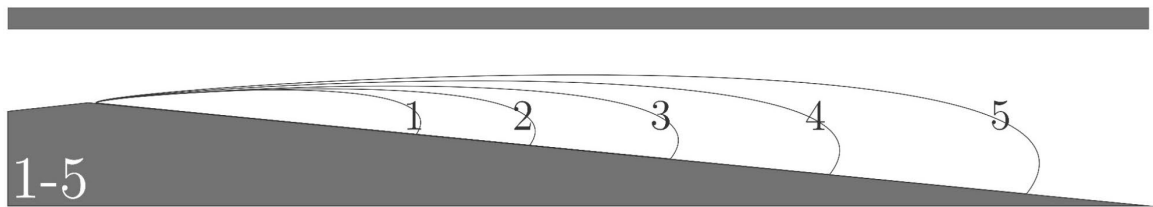

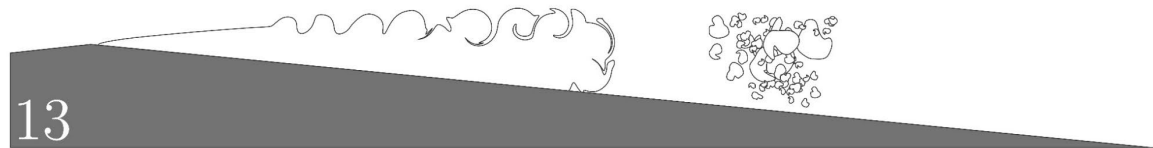
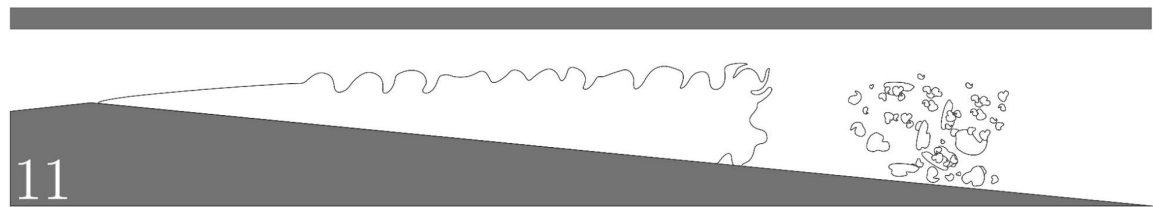
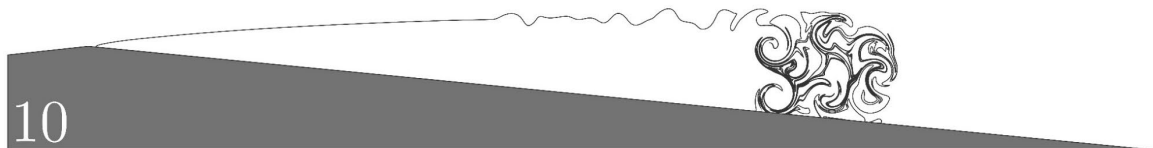
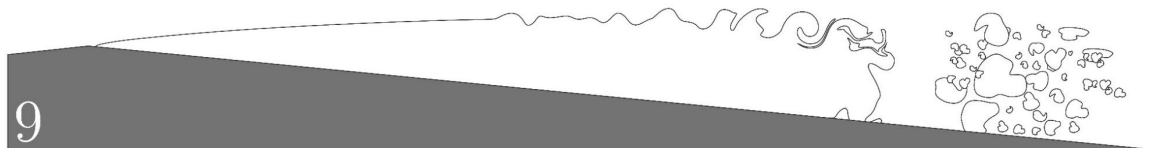
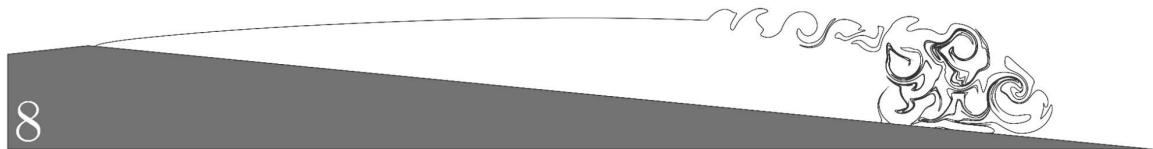
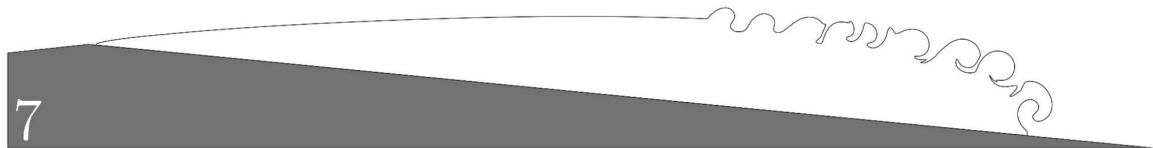
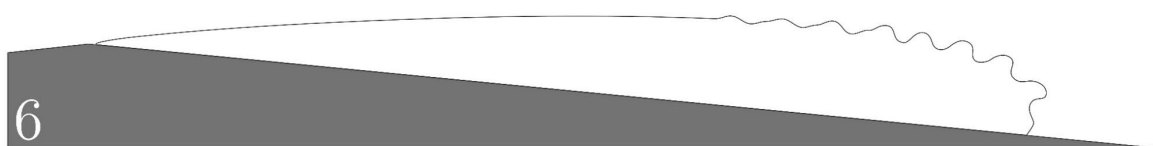
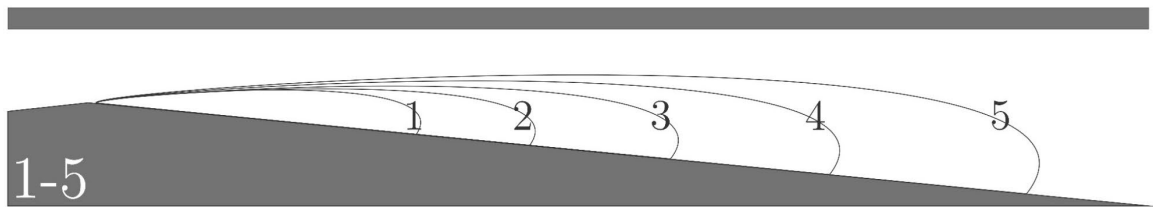

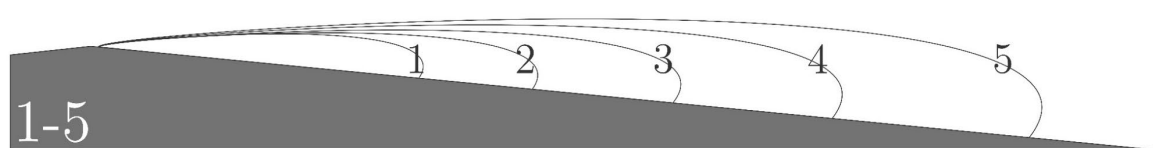
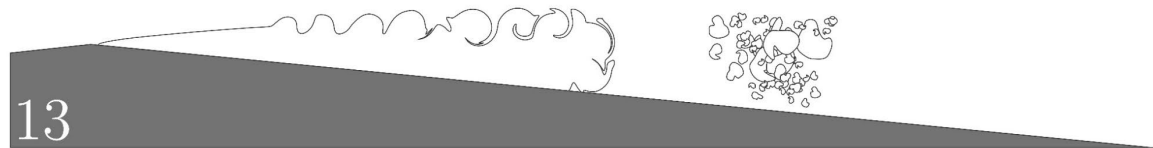
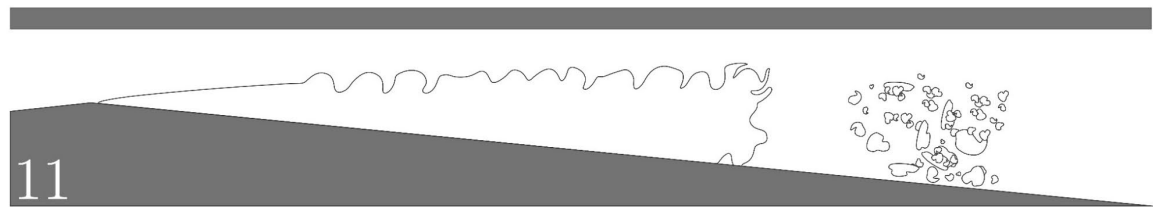
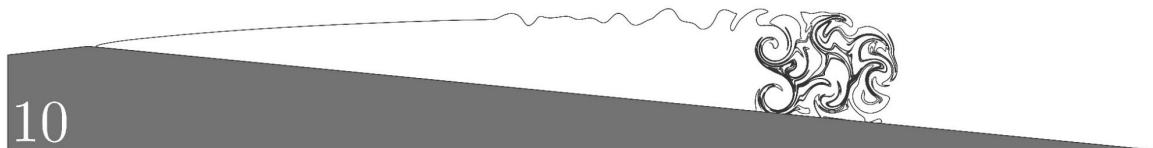
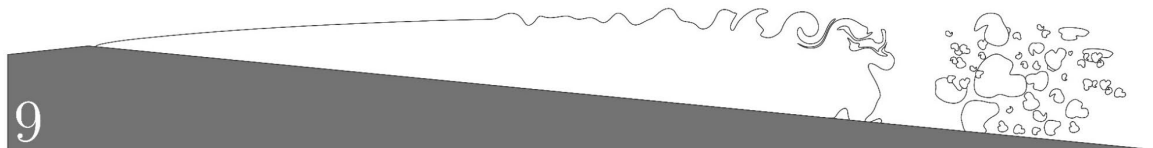
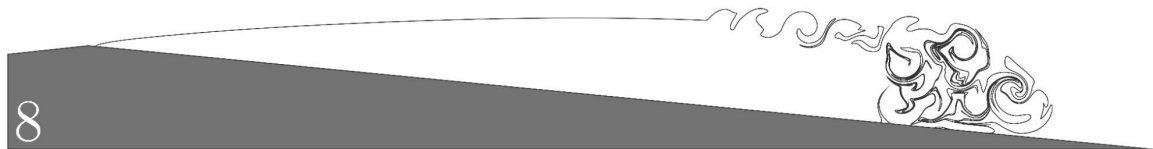
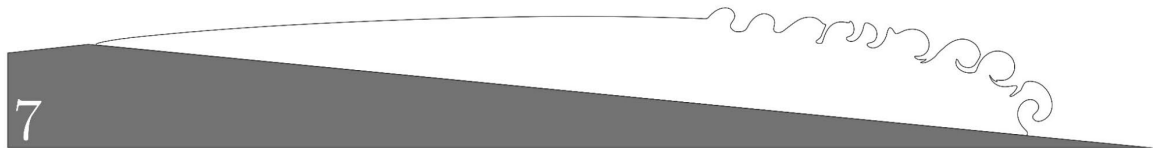
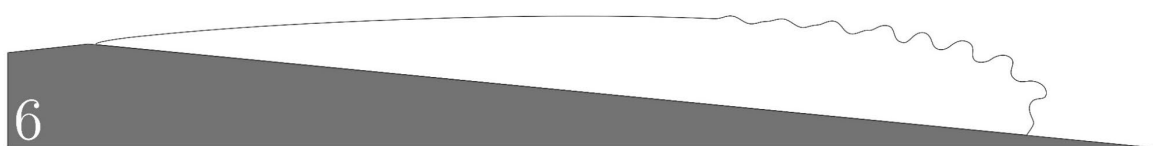
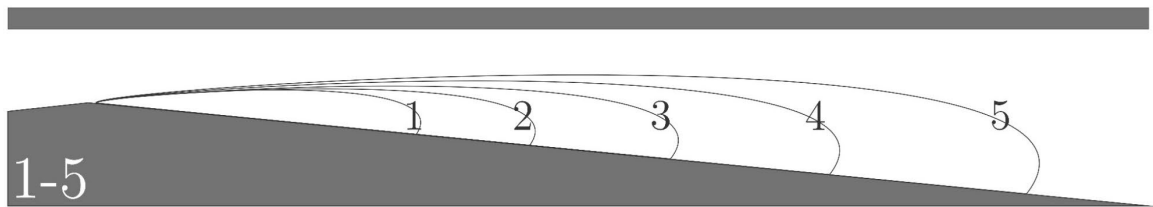

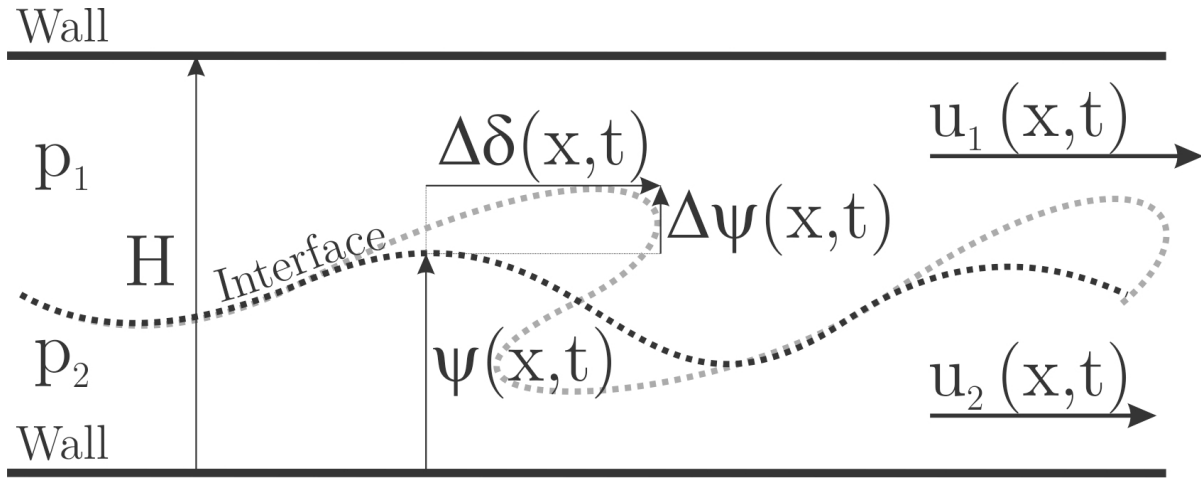
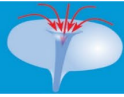

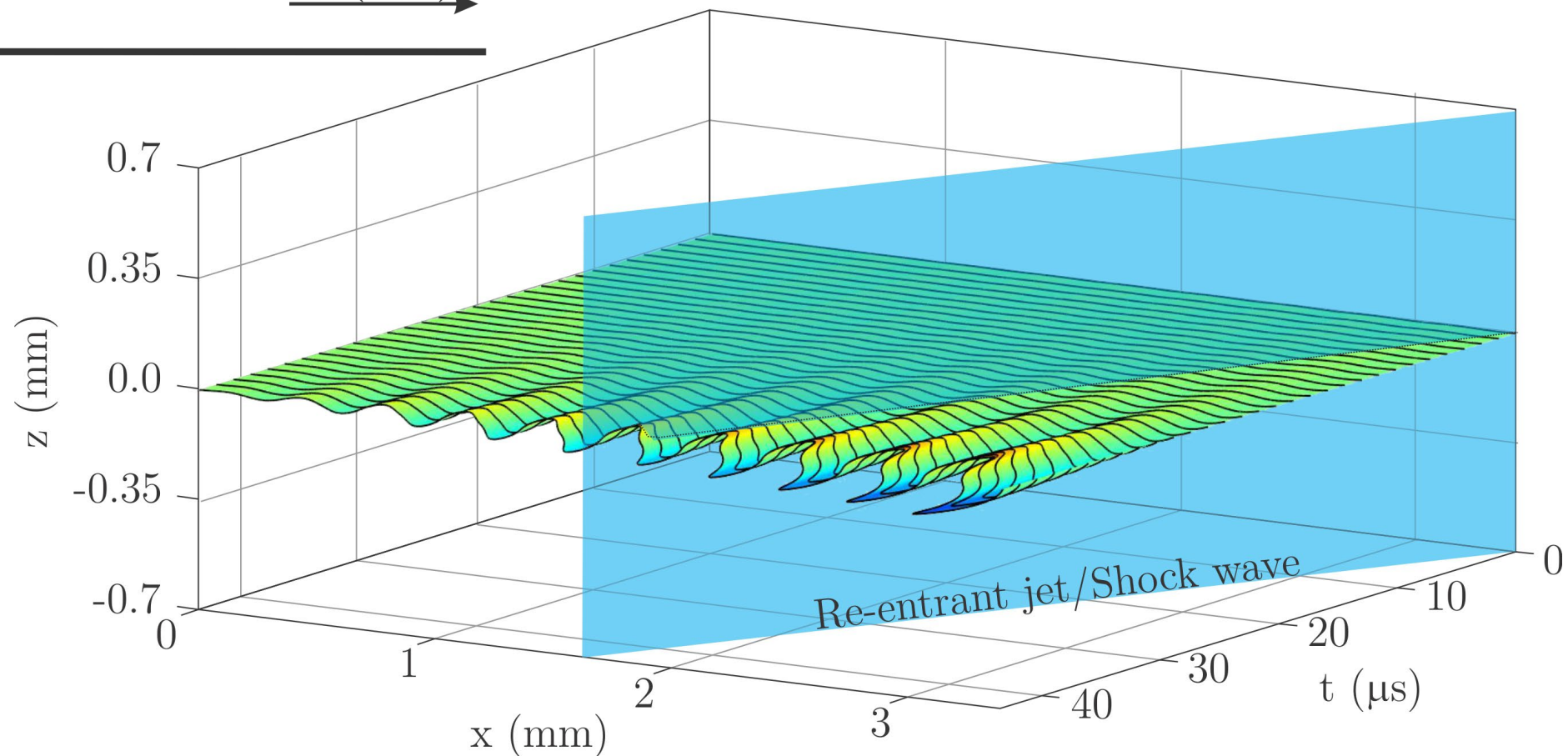
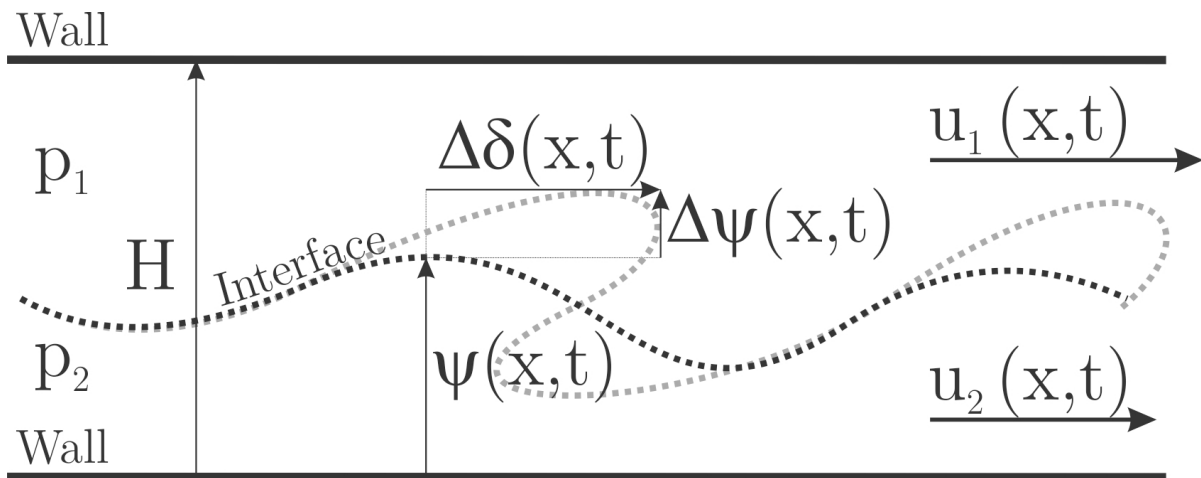

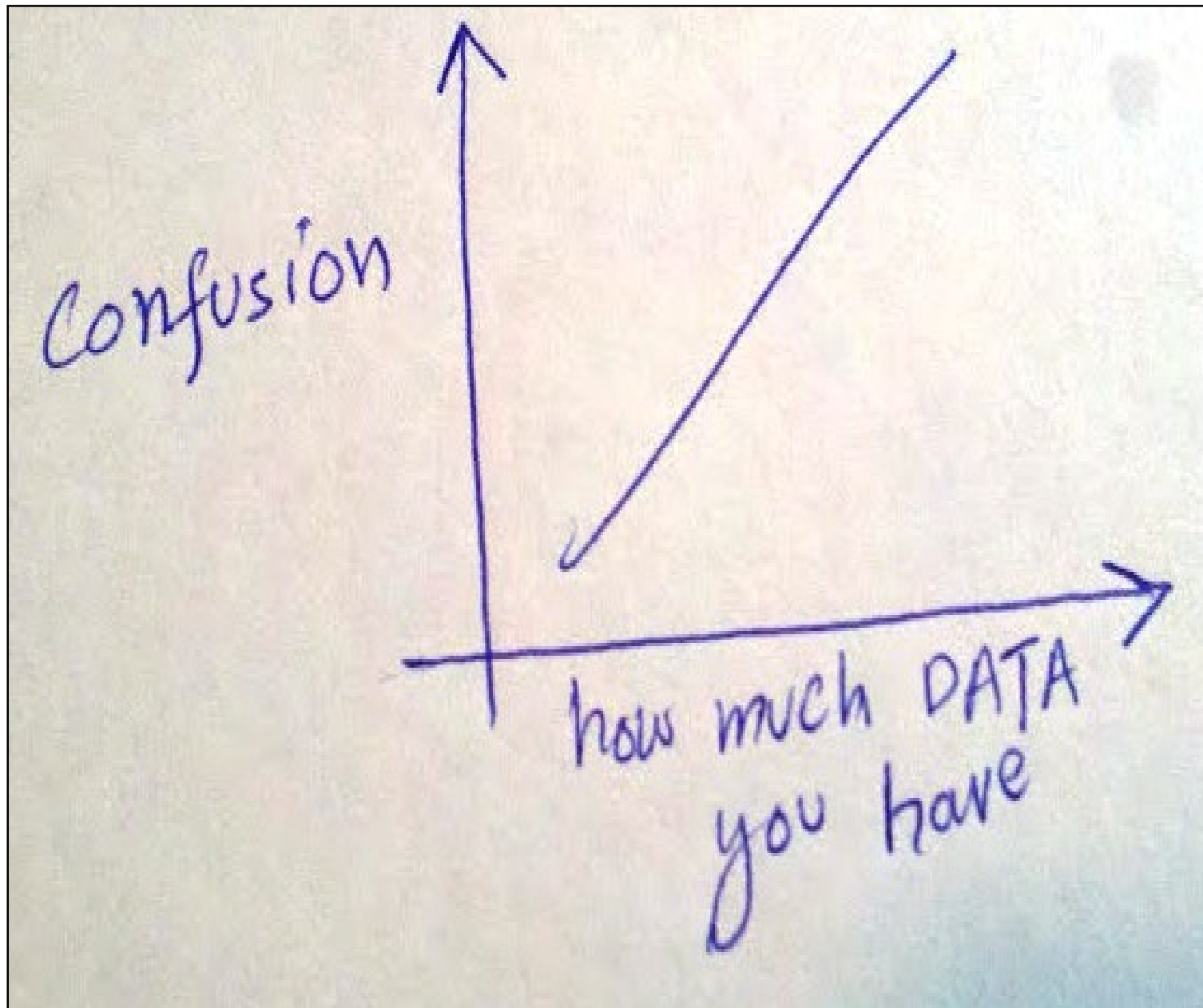



European
Research
Council

CABUM: An investigation of the mechanisms at the interaction between cavitation bubbles and contaminants

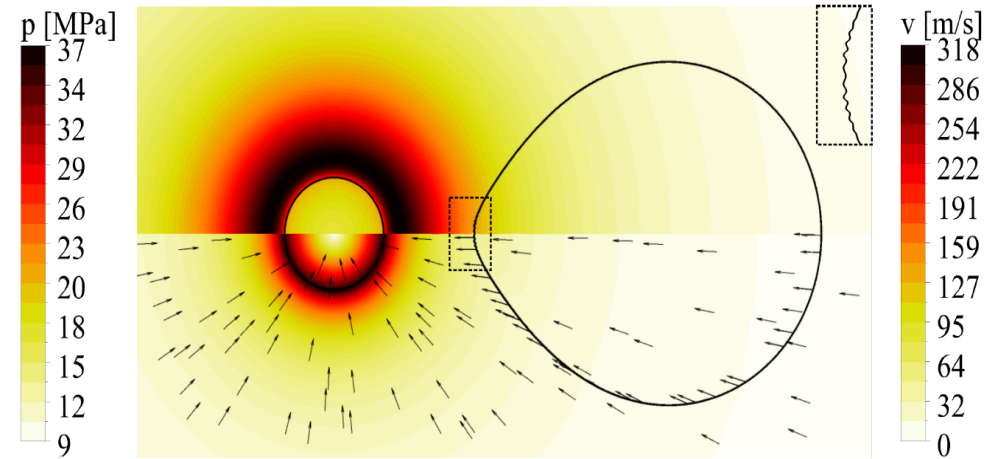
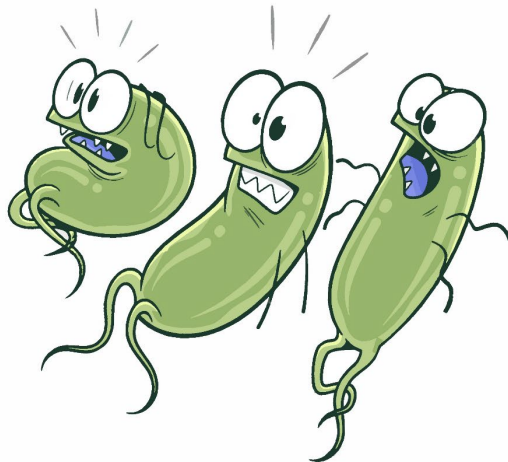

Pred

Po

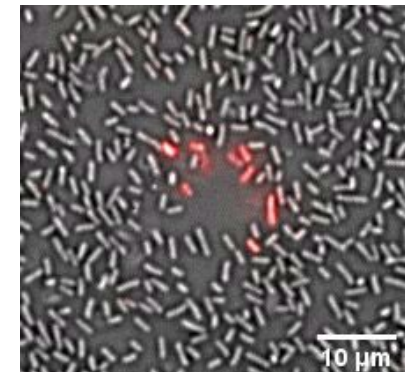
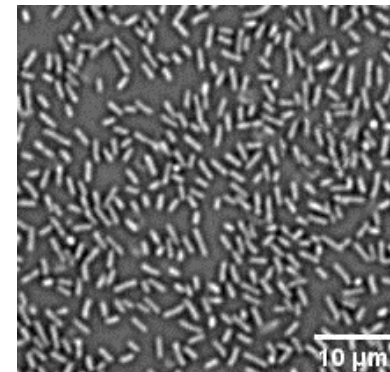



European
Research
Council

CAVIPHY: Exploitation of extreme cavitation conditions for wastewater treatment

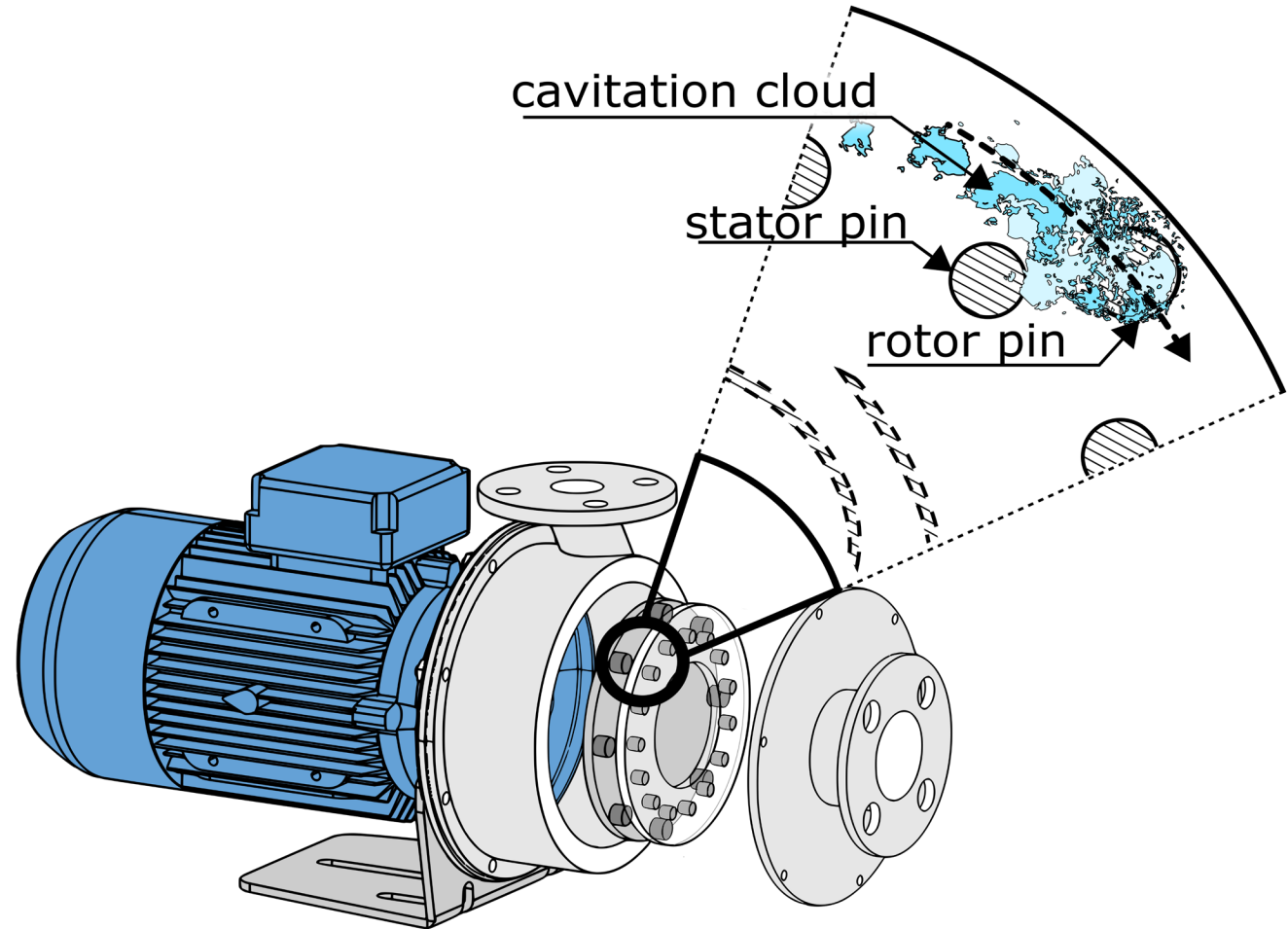
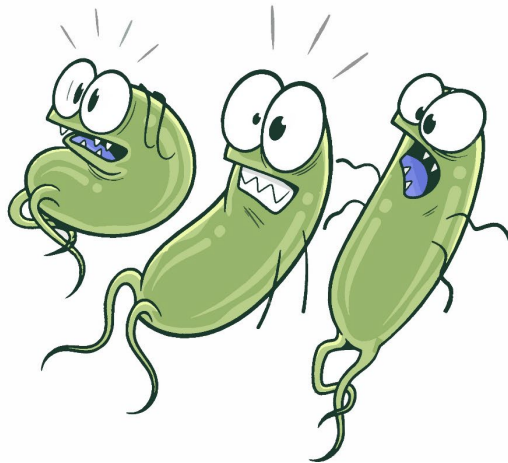





**European
Research
Council**

Matevž Dular

Fakulteta za strojništvo

Univerza v Ljubljani

Aškerčeva 6

1000 Ljubljana

Tel: 01 4771 453

E-mail: matevz.dular@fs.uni-lj.si

Web: www.matevzdular.com



ARRS

SLOVENIAN RESEARCH AGENCY



esa



Alexander von Humboldt
Stiftung/Foundation



Donirajte del dohodnine ASEFu

- **1% dohodnine** za financiranje upravičencev do donacij.
- Donacija dela dohodnine vas **ne stane nič**.
- Zadnji rok je **31. december 2022**.



Več o namenitvi dohodnine.

Kako oddati zahtevek:

1. **Elektronsko** prek portala eDavki.

- Vloga “Zahteva za namenitev dela dohodnine za donacije (Doh-Don)”.
- V vlogi vpišite naziv organizacije (Inštitut ASEF),
- davčno številko (84740175) in
- delež, ki ga namenjate (0,1, %, 0,2 %, ... 1%).

2. Z izpolnjevanjem **fizične kopije dokumenta** - lastnoročni podpis. Dokument lahko dobite danes pri nas. Na Finančni urad ga pošljemo na naše stroške.

Z vašo donacijo bo ASEF lahko še dalje omogočal nove priložnosti za mlade talente in povezoval Slovenijo s svetom.