

Best Effort Networks

- Delays - propagation + xmit + queuing + proc
- Loss
- Reordering
- Duplication

Dealing w/ Complexity

- Modularity – Layering
- Protocols → Rules

Layering

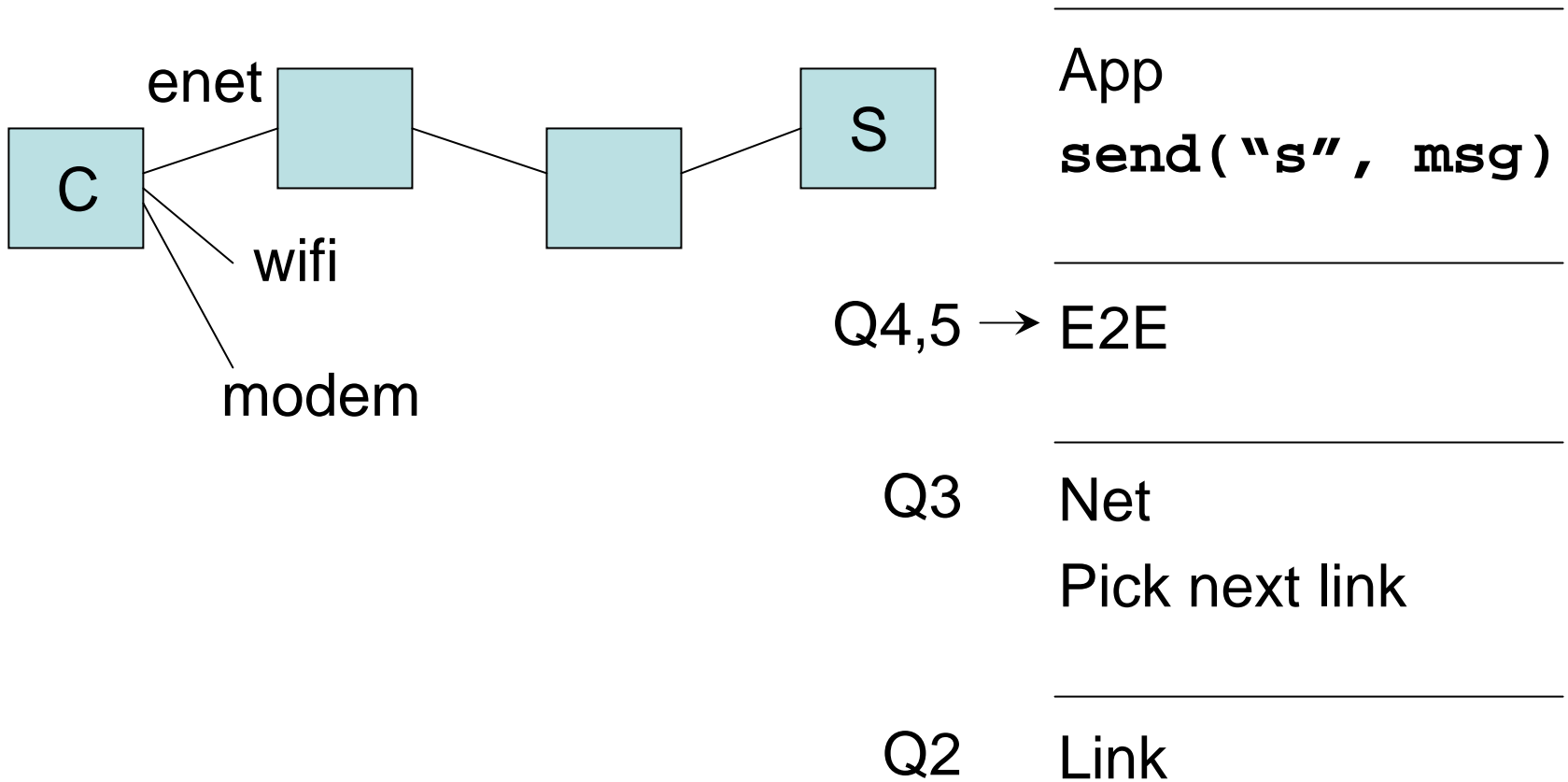

Encapsulation

Each layer add/remove its header/trailer

Don't look at / use payload from higher layers

Link Layer Issues

Digital → Analog → Digital

Framing

Channel Access

Carrier sense

Collision Detect

TDM

Error Detection/Correction

D → A → D

Sender

1010

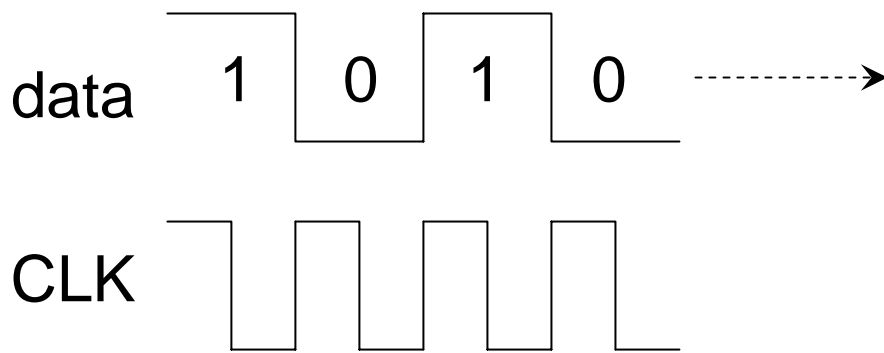

Rcvr

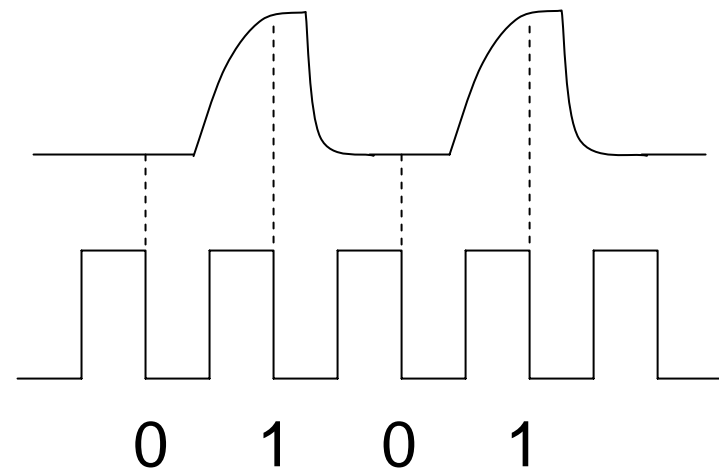

PLL

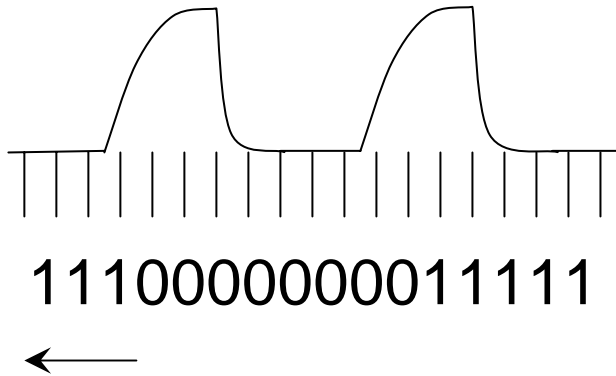

8x oversampling

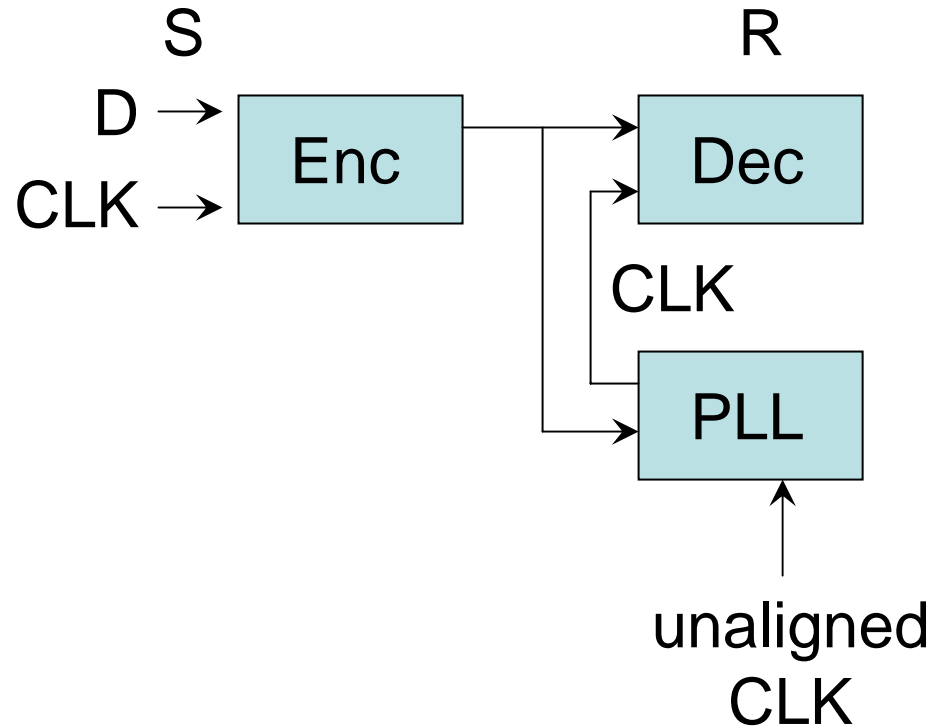

Manchester Encoding

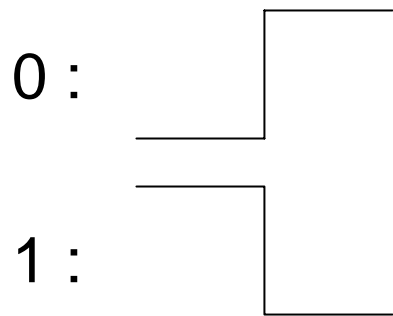

000

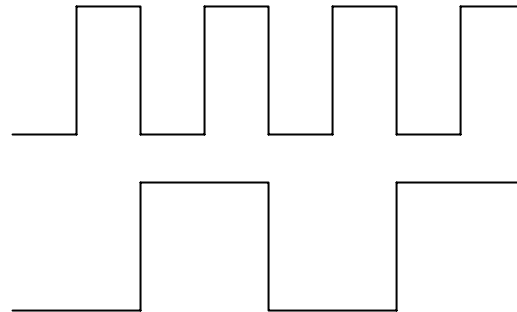

010

