

Civiele Gezondheidstechniek

Prof. Hans van Dijk



Cum Laude graduations
in drinking water



Karin Teunissen
Iron removal at groundwater
pumping station Harderbroek

graduate committee:
Prof. ir. J.C. van Dijk
Dr. ir. L.C. Rietveld
Dr. ir. S.G.J. Hoedemans
H. Leijster
Prof. dr. ir. M.C.M. van Loosdrecht



Doris van Halem
Ceramic silver impregnated pot
filters for household drinking
water treatment in developing
countries

graduate committee:
Prof. ir. J.C. van Dijk
Dr. ir. S.G.J. Hoedemans
Dr. ir. M.R. de Rooij
Prof. dr. G.L. Amy



On 6 July two MSc students in drinking water treatment received their Masters Title with honours. They were the 78th and the 79th graduates with prof. Van Dijk and the 3rd and the 4th of his students to receive MSc diploma with honours (cum laude).

Both graduates started their PhD studies in drinking water.



15 April 2007

1

Overzicht 3011 , deel Gezondheidstechniek

- Boek Drinkwater-principes en praktijk verkrijgbaar bij Mieke Hubert, kamer 4.55
- Vraagstukken in boek
- Computer assignments op blackboard
- Oude tentamens op blackboard
- 7 colleges conform schema

Drinkwater- principes en praktijk

Gezondheidstechniek	3011
Drinkwaterbedrijven	3011
Planning en ontwerp	3420
Financiën	3420
Waterverbruik	3011
Waterkwaliteit	3011
Grondwater	3420
Oppervlaktewater	3420
Distributie	3011

Colleges

- 27 sept. Inleiding gezondheidstechniek
- 1 okt. Waterkwaliteit 1: eisen/micro
- 4 okt. Waterkwaliteit 2: natuur/chemie
- 8 okt. Drinkwaterbedrijven 1: grondwater
- 11 okt. Drinkwaterbedrijven 2: oppervlaktewater
- 15 okt. Waterverbruik
- 18 okt. Distributie

Excursie naar de Berenplaat op 11 oktober na college

Wat is Gezondheidstechniek?

grondwater



drinkwater



oppervlaktewater



afvalwater



riolering

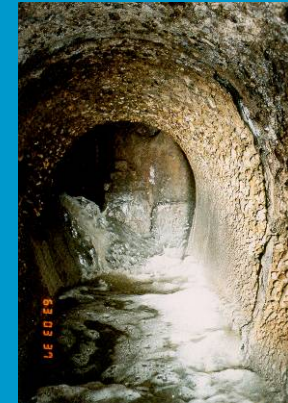

Schoon water voor een gezond leven..

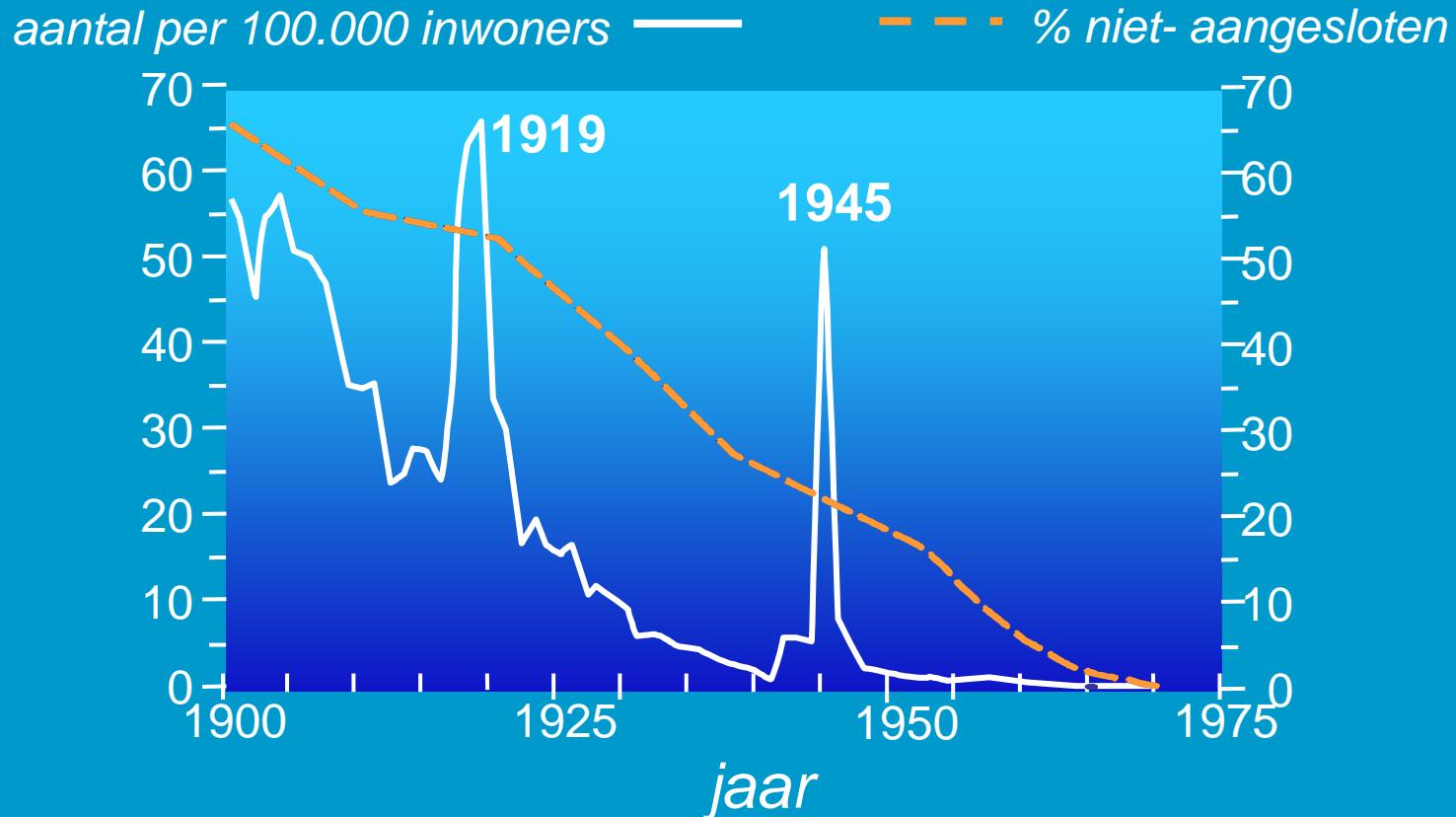

Wat is Gezondheidstechniek?

Goede waterkwaliteit ten dienste van mens en milieu

Kennis van:

- waterwinning
- waterzuivering
- watertransport
- waterchemie
- microbiologie



Wat is Gezondheidstechniek?

Gezondheidstechnisch ingenieur maakt gebruik van kennis van:

- hydraulica
- hydrologie
- constructieve vormgeving
- informatica
- projectrealisatie



Wat is Gezondheidstechniek?

- van groot belang voor de volksgezondheid
- grootschalige gespecialiseerde infrastructuur
- goed georganiseerde sector met heldere taken



Drinking water and Delft

75th MSc graduate in drinking water (1991-2006)



Gert-Jan Schers (1991)



Qing Wang (2006)

Graduates with prof. ir. J.C. van Dijk:

1991 Gertjan Schers	1995 Jan Leen van der Vlies	1997 Steven Oterdoom	2002 Remco Keijser
1992 Robert Willemsse	1995 Gert-Jan Schoterman	1997 Martin de Koning	2002 Angela Puts
1992 Idsart Dijkstra	1995 Marieke van Winkelen	1997 Michiel Riemersma	2002 Martijn Kramer
1993 Carel Aeyelts Averink	1995 Mireille Beumer	1997 Jonneke Klomp	2002 Guy Heijnen
1993 Jan Timmer	1995 Marc Elkens	1998 Siebe van der Zel	2004 Sarwan Raktoe ²
1993 Georgina Martinez Ortiz	1995 Edgardo Valeriano	1998 Bonne Hijkema	2004 Michiel van der Meulen
1993 Jenne van der Velde	1995 Peter Tienhooven	1998 Alex van der Helm ³	2004 Christiaan Kivit
1993 Peter Wessels	1996 Marc Brieskorn	1999 Jeroen Krijgsmann	2005 Maarten Lut
1994 Nico Versteeg	1996 Jasper Verberk	1999 Bram Martijn	2005 Menno van Leenen
1994 Ellen van Duikeren	1996 Maarten Keuten	1999 Johan Boel	2005 Jan-Hendrik Vos
1994 Roel Brands	1996 Pijs-Hein Spaans	1999 René van der Au ^{1,2}	2005 Anke Grefke ³
1994 Patrick van der Wens	1996 Ernst-Jan Hageman	2000 Johannes Vijlbrief	2005 Shaarleen Alberga
1995 Petra Holzhaus	1996 Martijn Nijjse	2000 Ignaz Worm ¹	2006 Leo Meijer
1995 David Vischer	1996 François v. Ekklandonk ¹	2000 Anton van Rosmalen	2006 David de Ridder
1995 Ronald van den Berg	1996 Marij Hendriks	2000 Jan Post ²	2006 Qing Wang
1995 Hella van de Maarel	1996 Joukje Ketuning	2001 Sian Gwan Tan	
1995 Orjan van Drongelen	1996 Erik Schwenke	2001 Maaikje Glastra	
1995 Martijn Bakker	1996 Eelco Trietsch	2001 Pepijn Koenders	
1995 Patrick Smeets	1997 Jan-Dik Verdell	2002 Colette de Roo	
1995 Bas van Efferen	1997 Weren de Vet	2002 Michel Bretveld	

¹ Graduation with honours (cum laude)
² Gijz Oskam Award for best young researcher
³ Faculty Award for best graduation



Delft University of Technology



Celebrating the completion of design course



Crown Prince Willem-Alexander during a guest lecture at TU Delft

DrinkingWater

Principles and Practices

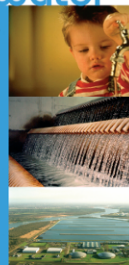

P. J. de Moel
 J. Q. J. C. Verberk
 J. C. van Dijk



PhD graduation of Jasper Verberk (2005)

28 september 2007



Wat doet een waterleidingingenieur?

Studies

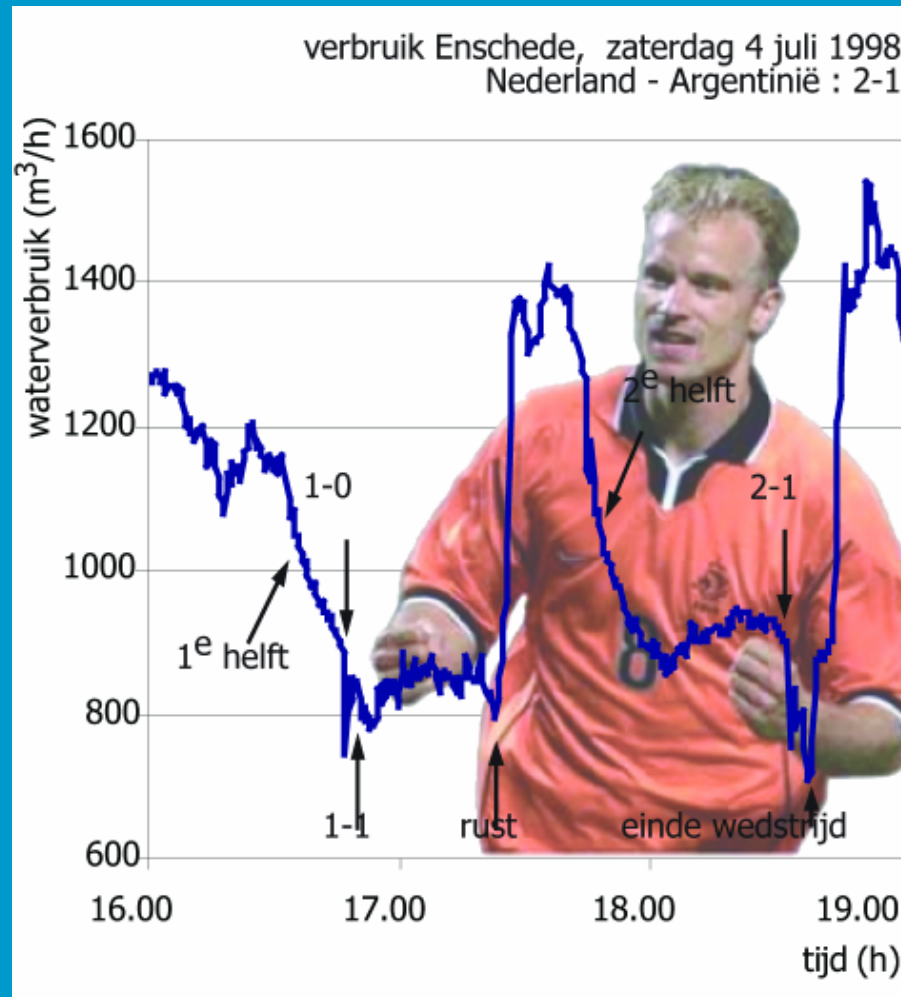

Wat doet een waterleidingingenieur? Ontwerpen

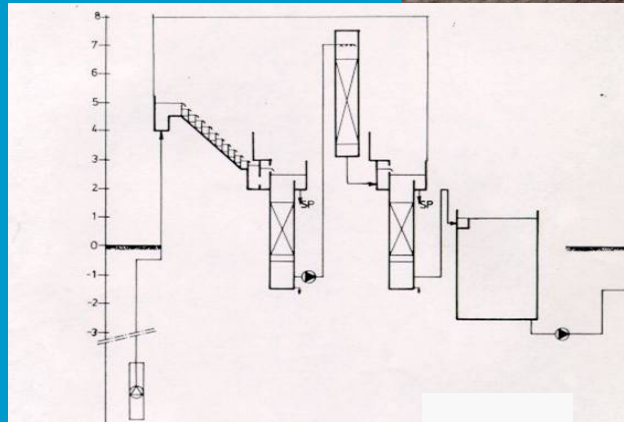
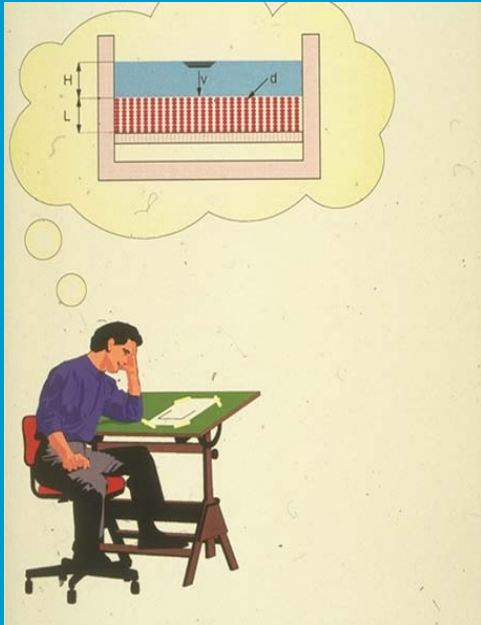

Wat doet een waterleidingingenieur?

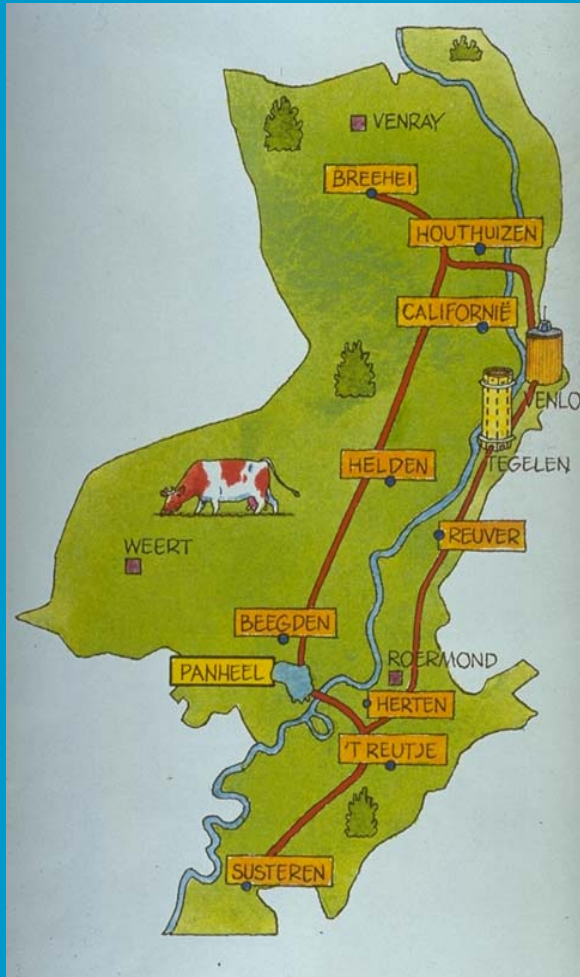

Wat doet een waterleidingingenieur?



28 september 2007

14

Wat doet een waterleidingingenieur? Onderzoek



Dutch drinking water: principles and practices



Prof. ir. Hans van Dijk

28 september 2007

Drinking water in the Netherlands

- Total volume: 1.2×10^9 m³/jaar
- Sources
 - Groundwater: 2/3
 - Surface water: 1/3
- Treatment
 - Groundwater: aeration and sand filtration
 - Surface water: very extensive treatment
- Distribution
 - *no chlorine!*



Principles and practices:1

1. Focus on public health...
2. Large publicly owned private companies...
3. With joined efforts for research and communication

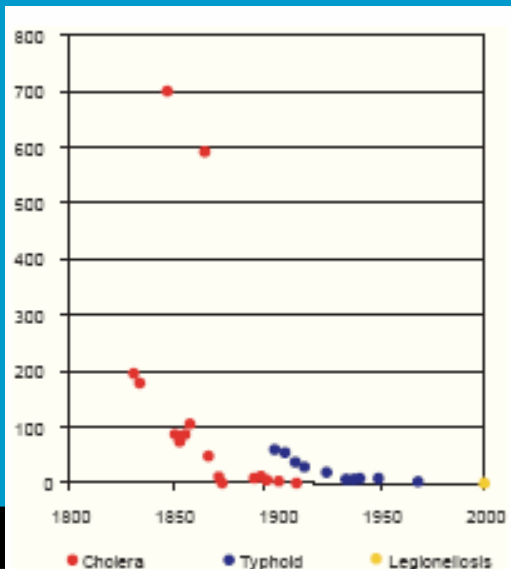

Mortality per 100,000 person in the Netherlands by drinking water related diseases (RIVM)

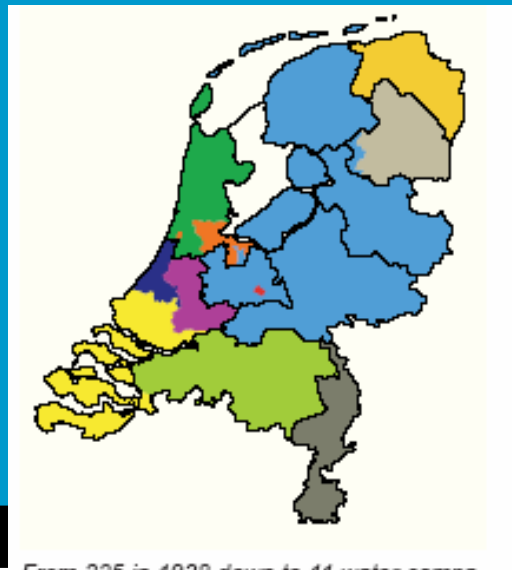

From 225 in 1938 down to 11 water companies in 2006, and still merging (TU Delft)



Principles and practices: 2

1. Source protection
2. Safe groundwater when available...
3. Or artificial groundwater...
4. Or surface water with multiple barriers for micro-organisms, pollutants and nutrients...

- grondwater
- oppervlaktewater
- infiltratiewater
- oevergrondwater



Source protection

Enforcing environmental protection laws in Europe
Early warning along Rhine and Meuse
Large reservoirs to overcome contamination waves

Reliable treatment

Self-purification in reservoirs
Double filtration systems
Absorption and oxidation processes
Safe water even during a failure

Multiple barriers in drinking water production from surface water

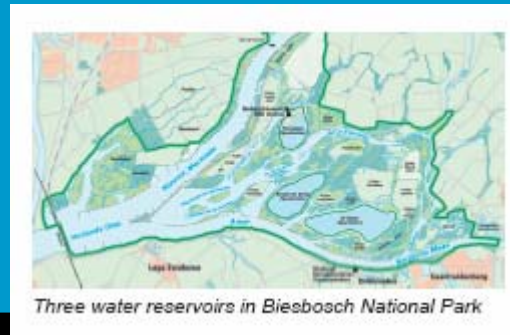

Three water reservoirs in Biesbosch National Park

Source	Number of locations	Abstraction (million m ³)
Groundwater (natural)	192	709
Artificial groundwater (riverbank filtration)	12	61
Artificial groundwater (dune infiltration)	7	214
Surface water (reservoirs)	7	293
Total	218	1,277

Different sources for drinking water production in the Netherlands in 2004 (VEWIN/RIVM 2004)

Source protection



Waterbedrijven eisen verbod lozen bentazon

Van onze verslaggeefster
DEN HAAG — Er is onenigheid ontstaan tussen de waterleidingbedrijven en het kabinet over de aanpak van de omstreden chemische stof bentazon. Deze is aangetroffen in het drinkwater

consument dan 10 tot 20 cent meer voor een kubieke meter water betalen.

De wettelijke norm voor de aanwezigheid van pesticiden is 0,1 microgram per liter leidingwater. Die norm is door alle EG-landen onderschreven op grond van

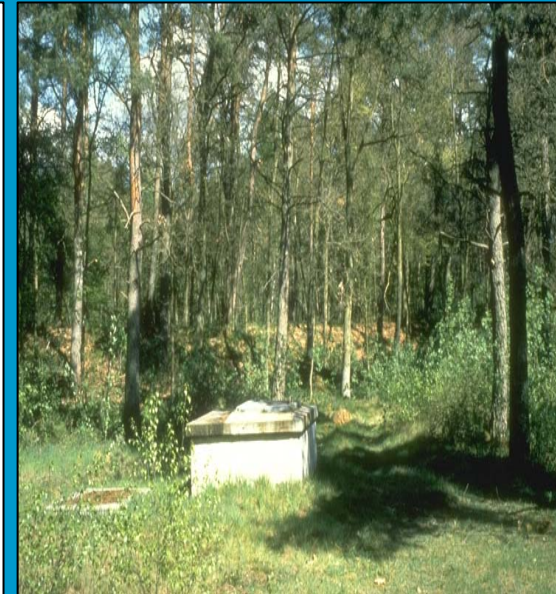

Groundwater



Artificial recharge

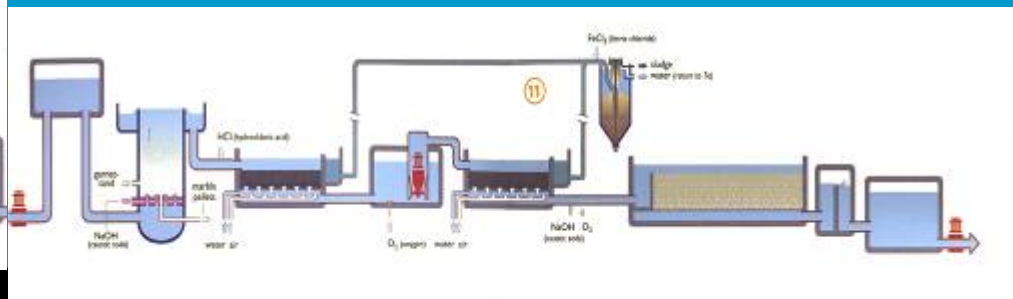
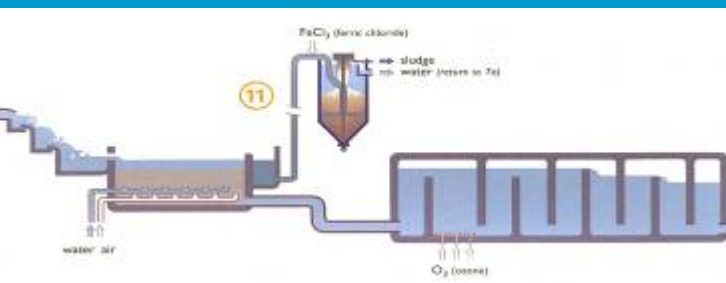
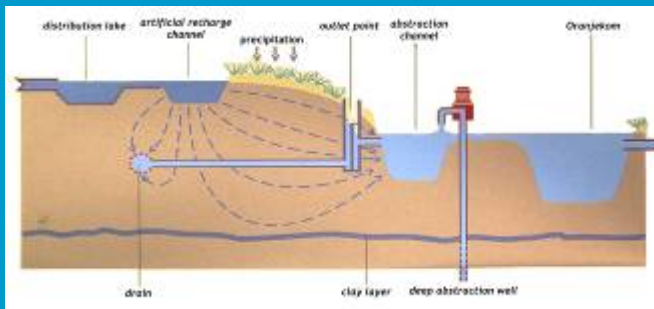
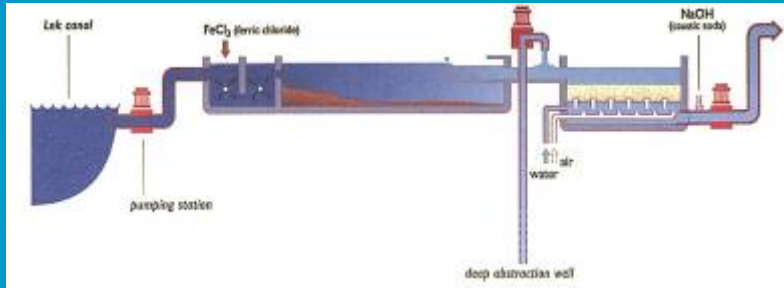

28 september 2007

Multiple barriers...

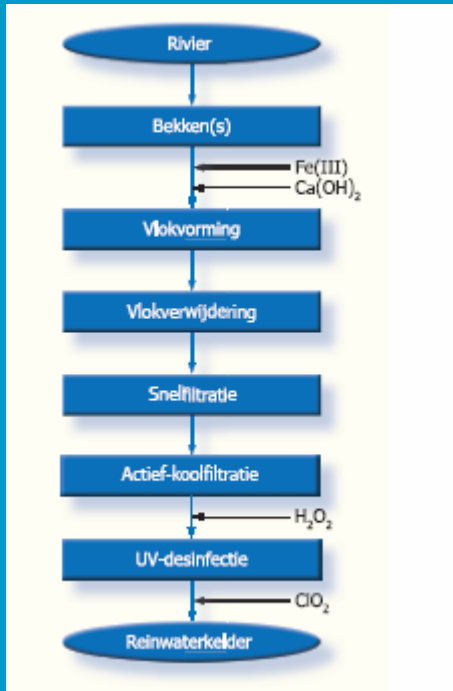

Modern technology...



UV for disinfection at Andijk (PWN 2005)

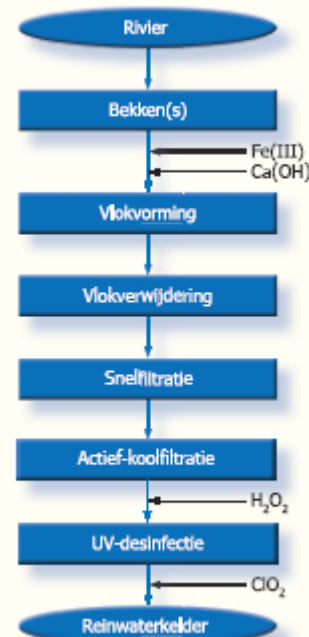

Principles and practices: 3

1. High quality water without chlorine...
2. And with a low hardness...
3. So the customers drink water from the tap



Public health	The environment	Comfort	Economics
Less lead, copper and zinc No risky home filters	Less phosphate Less household waste water Less metals in waste sludge	Better soap while showering Better taste Better appearance (tea) Less scaling in hot water	Savings on washing powder Savings on home-filters Savings on scaling Overall lower costs

The benefits of soft drinking water are recognized in the Dutch drinking water regulations

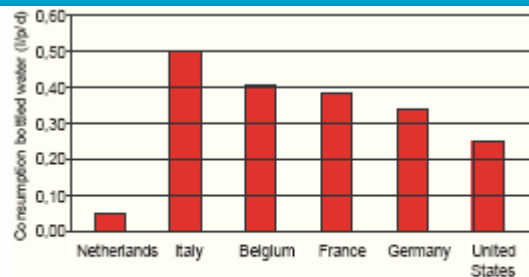

Consumption of bottled water (Bottled water reporter 2005/VEWIN 2006)



Principles and practices: 4

1. No leakage...
2. Reliable systems...
3. Stimulate water saving...

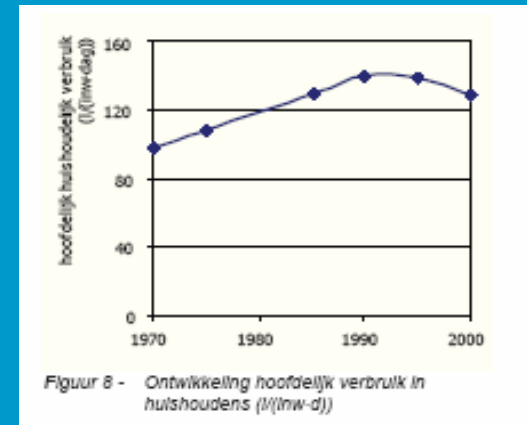
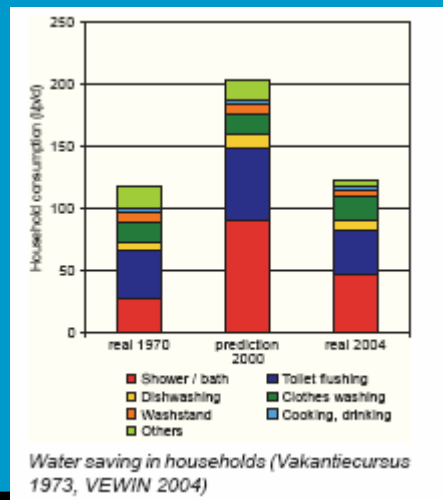
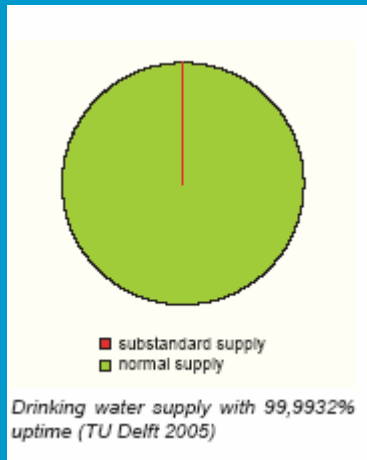
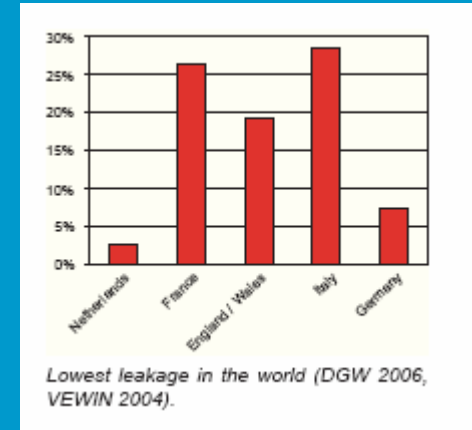

The miracle from the tap

High quality water supply

- No waterborne diseases
- No chlorine
- No pesticides
- No hard water
- No corrosion and metals
- No leakage
- No need for home filters
- No need for bottled water
- No wasting of water



(Kleinschalige) drinkwaterzuivering in ontwikkelingslanden

Uitdagingen voor de (civiel) ingenieur

College Inleiding Watermanagement

ir. Doris van Halem D.vanHalem@tudelft.nl

27 september 2007

1

Inhoud

- Inleiding
- Low-cost drinkwaterzuivering
- Recente ontwikkelingen
- Onderzoek aan de TUD
- Slot

Millenniumdoelstellingen

Millennium Development Goals (MDG's)

#7 'Halve, by 2015, the proportion of people without sustainable access to safe drinking water and basic sanitation'

Proportion of urban population using improved drinking water sources, 2004 (Percentage)

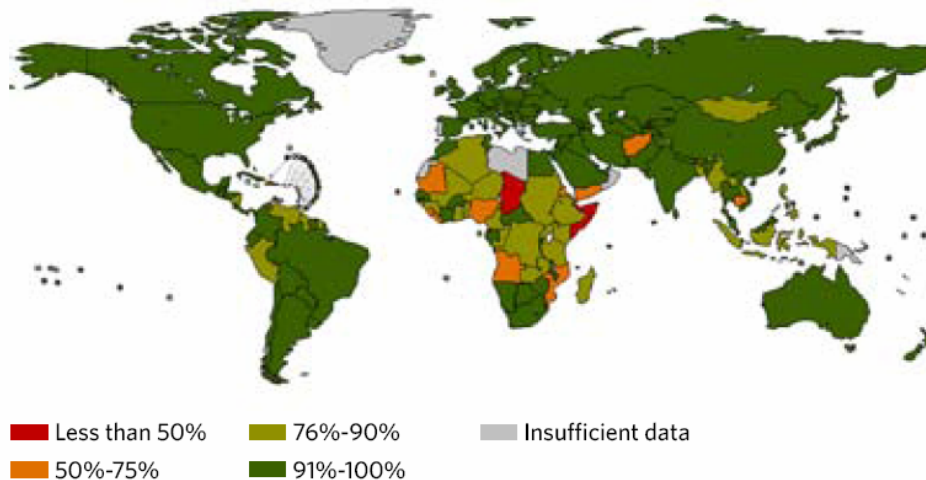

Waterbronnen



Oppervlaktewater sterk variërende waterkwaliteit (hoge piekconcentraties) - soms niet beschikbaar gedurende het gehele jaar



Grondwater constante kwaliteit (microbiologisch betrouwbaar) - zuurstofarm, kan problemen geven met Fe, Mn (of zelfs As)



Regenwater grote kans op herbesmetting tijdens opvang en opslag - niet beschikbaar gedurende het gehele jaar

Kwantiteit/kwaliteit

Waterkwantiteit: >2 liter/dag

Waterkwaliteit:

Pathogene micro-organismen: bacteriën, virussen en protozoa

(Zware) metalen

Nitraat en ammonium

Opgelost organisch materiaal

Pesticiden, geneesmiddelen, hormonen

Pathogene micro-organismen

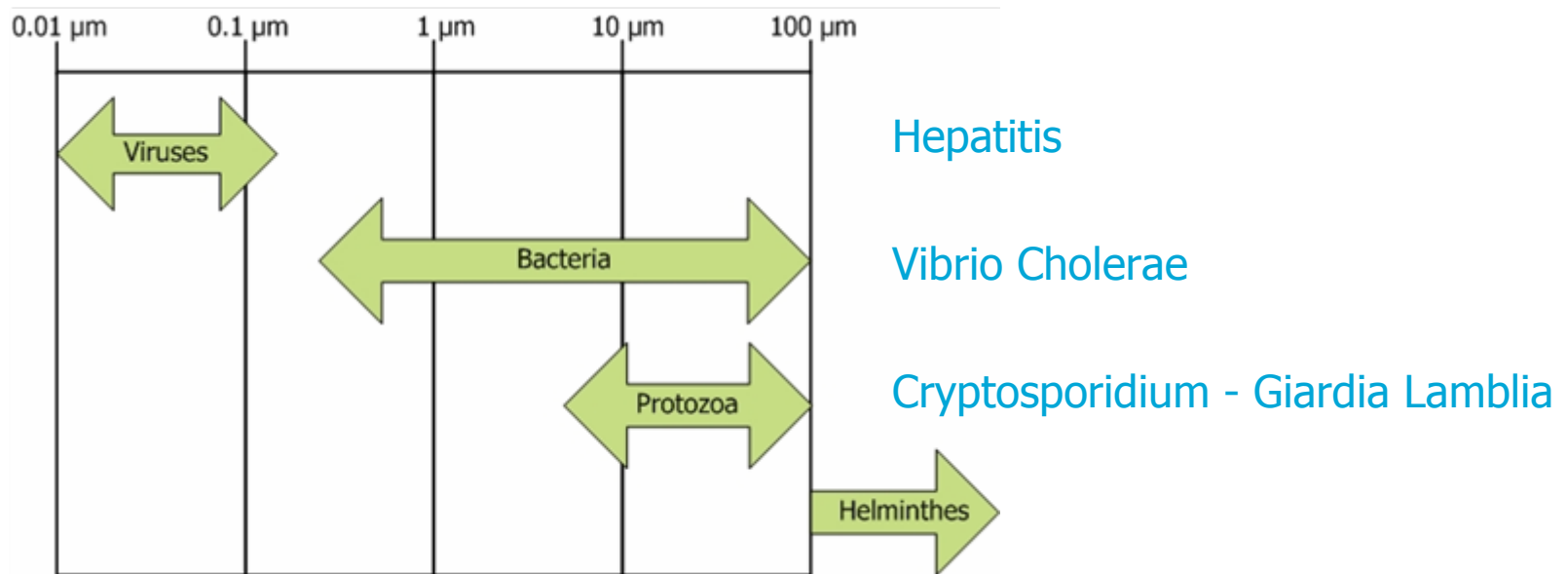

Wereldgezondheidsorganisatie: geen coliformen in een 100ml monster

Drinkwaterzuivering

Op welke schaal?

Stedelijk gebied

Hele stad - herbesmetting in distributienetwerk – fluctuerende aanvoer

Wijk - kwaliteitscontrole lastig - soms hoge prijzen

Plattenland

Dorp - organisatorische problemen

Huishouden - tijdrovend & grote kans op verkeerd gebruik

Low-cost drinkwaterzuivering

Keramische filtratie - pot, candle and disk shape

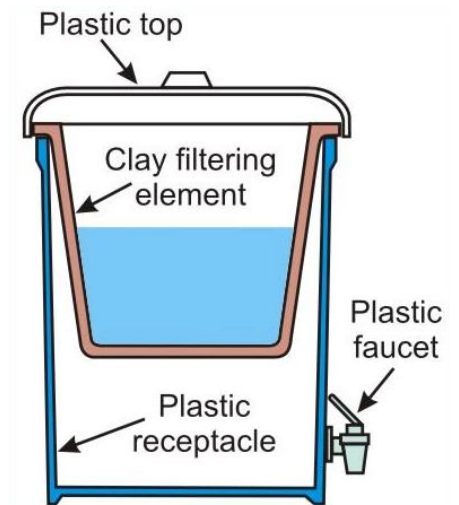

Low-cost drinkwaterzuivering (2)

Solar DISinfection (SODIS) - PET flessen

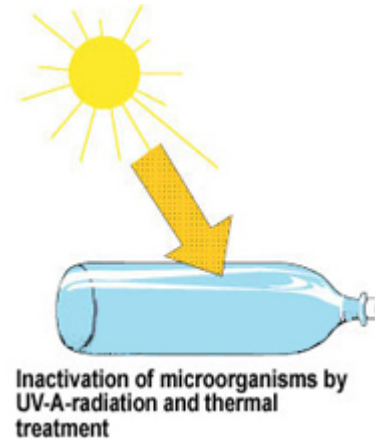

Low-cost drinkwaterzuivering (3)

(Zand)filtratie - zand, grind en adsorptiemedia

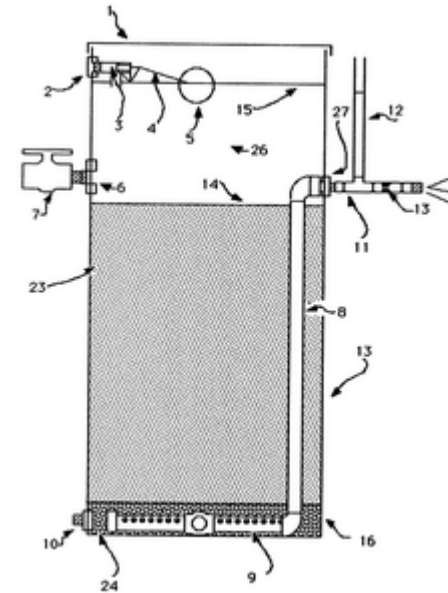
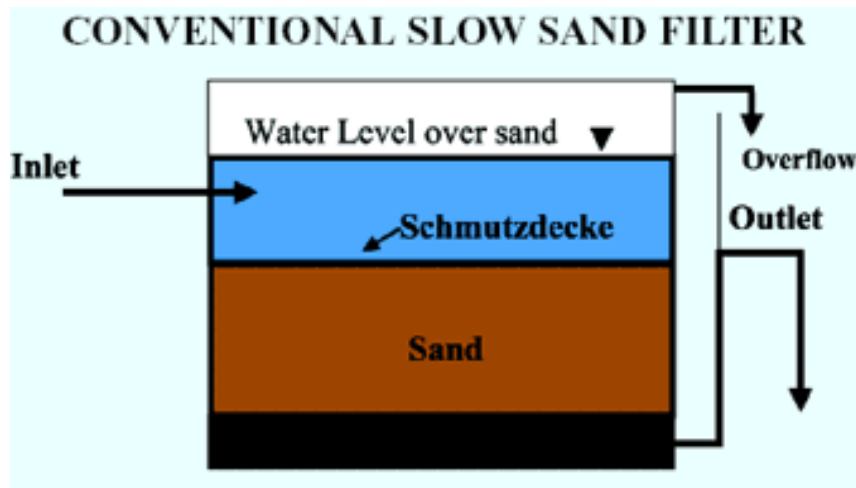

Recente ontwikkelingen

WaterPyramid – solar, regenwater (en chloordosering)

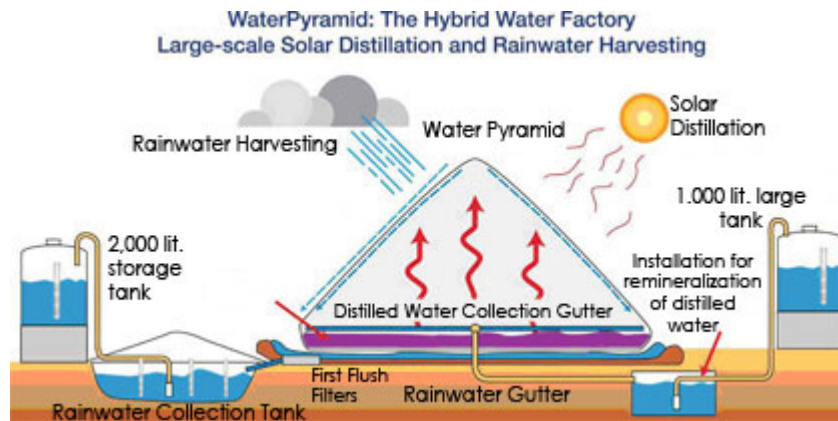

Recente ontwikkelingen (2)

Perfector-E - ultrafiltratie en UV-desinfectie

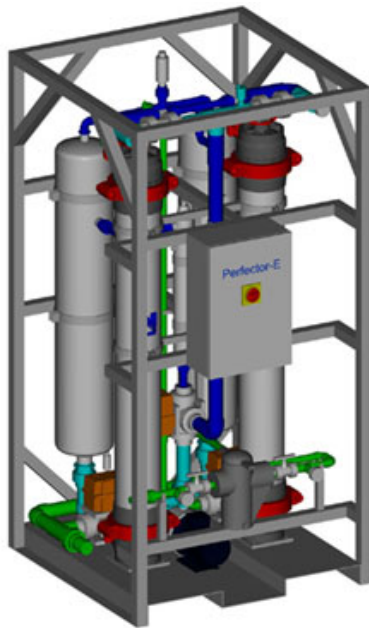

Recente ontwikkelingen (3)

Arseenverwijdering - ijzer(hydr)oxiden, spijkers en baksteen



Onderzoek aan de TUD

Keramisch pot filter geïmpregneerd met zilver

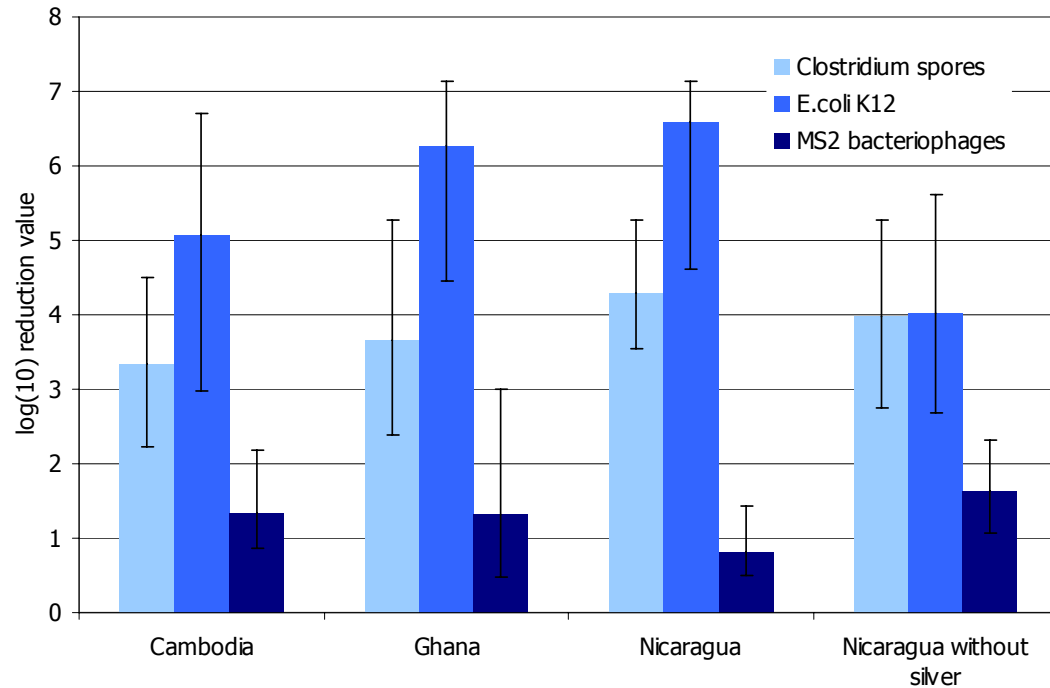

Onderzoek aan de TUD (2)

Keramisch pot filter geïmpregneerd met zilver

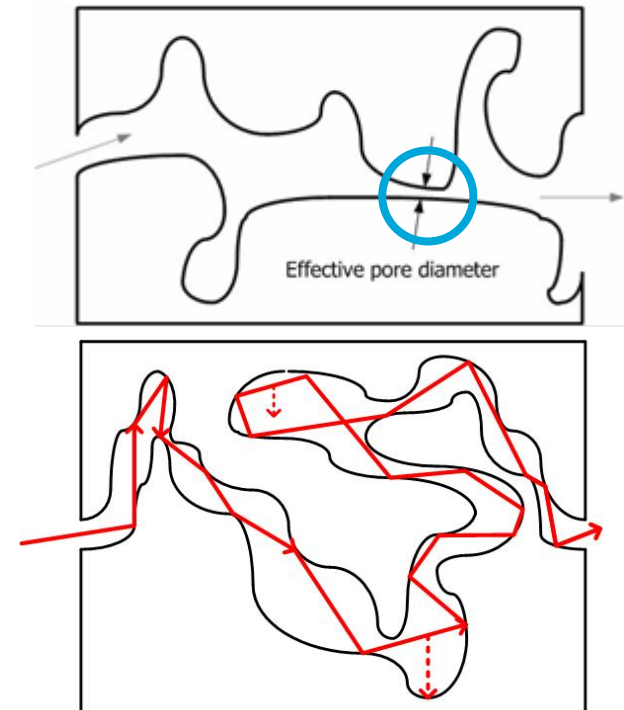
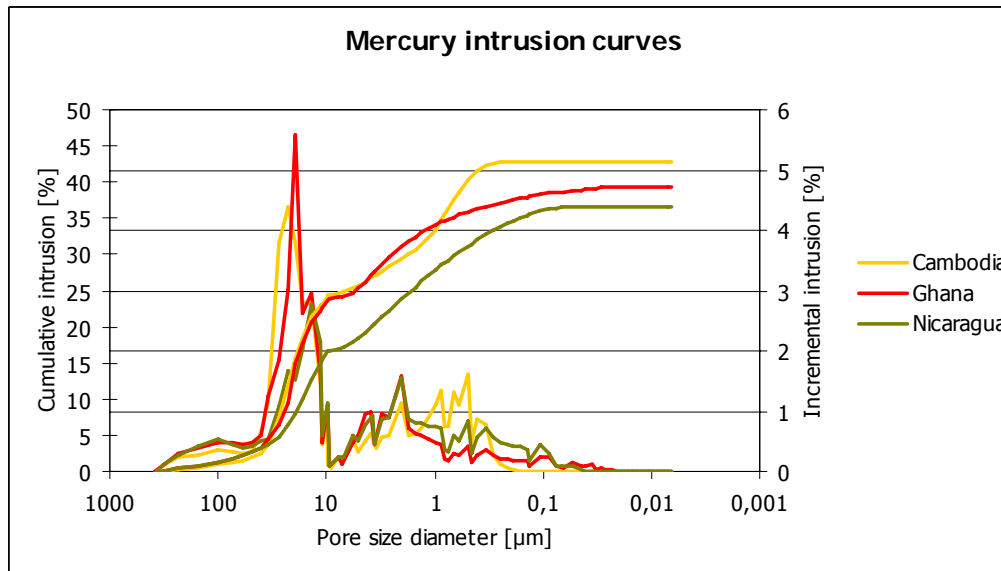

Onderzoek aan de TUD (4)

Langzaam zandfiltratie op dorpschaal in Benin, West-Afrika



Onderzoek aan de TUD (5)

Combinatie langzame zandfiltratie en UV desinfectie

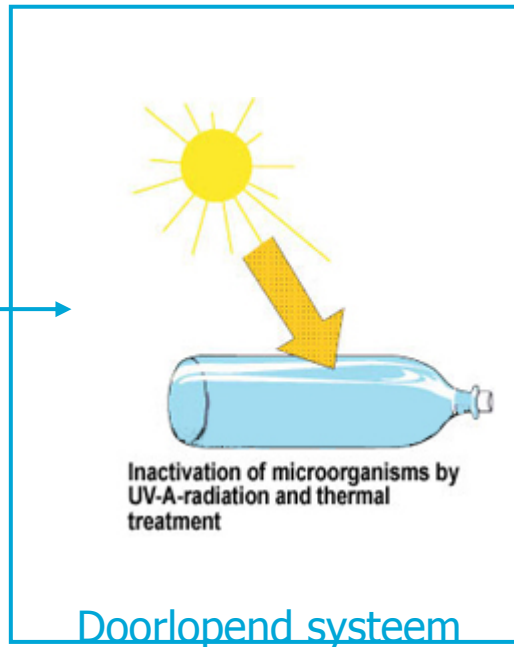

Smutzdecke: kokos/jute
Temperatuur/radiatie

Onderzoek aan de TUD (6)

'Drinken van de wind' - RO/windenergie

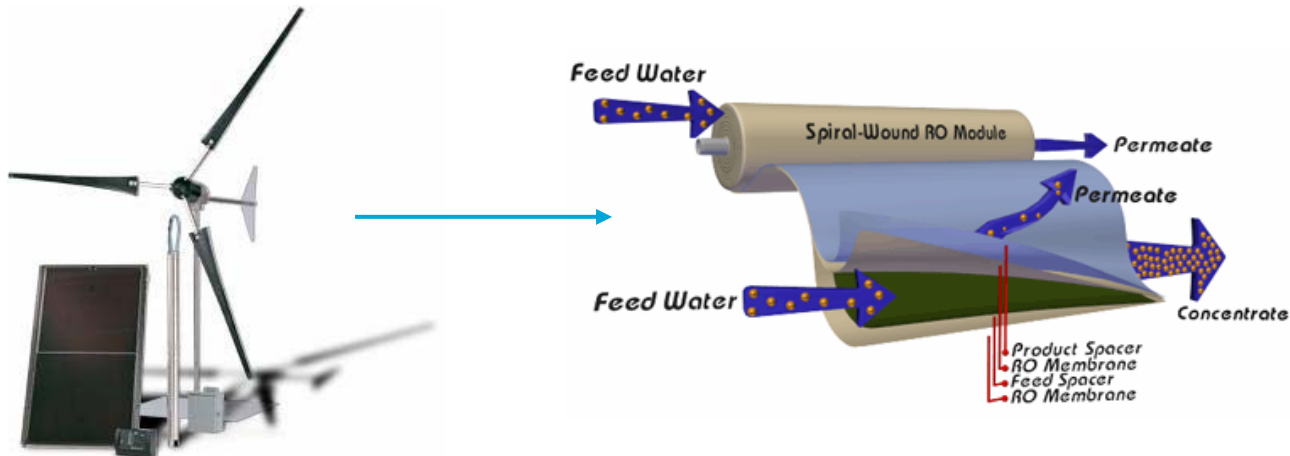

Pilot - Kaap Verdië

Onderzoek aan de TUD (7)

Schelpenfiltratie in Suriname



Onderzoek aan de TUD (8)

Arseenverwijdering met ondergrondse beluchting



Arseen in drinkwater veroorzaakt op de lange termijn pigmentvlekken, "black-foot disease", huidkanker,... (WHO)

Onderzoek aan de TUD (9)

Arseenverwijdering met ondergrondse beluchting

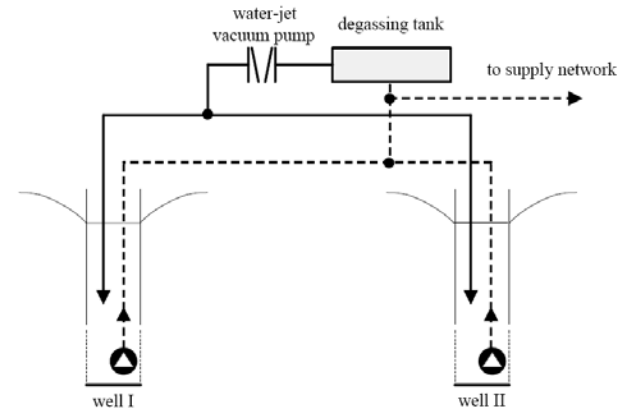

Periodieke injectie van zuurstofrijk water in het arseen- en ijzerrijke anaerobe watervoerende pakket

Onttrekking van arseenvrij grondwater - toepasbaar op het platteland van Bangladesh?

Onderzoek aan de TUD (10)

TUD - samenwerkingsverbanden

Werktuigbouwkunde - drinken van de wind

Technische aardwetenschappen - ondergrondse arseenverwijdering

Microbiologielab (Klyver) - UV desinfectie

Industrieel Ontwerpen - design for the Bottom of the Pyramid
[Life Straw voor kleine kinderen](#)



Slot

Uitdagingen voor de drinkwatertechnoloog

high-tech vs. low-tech (?)

community-scale vs. household (?)

low-cost!

sociaal-culturele context

lokale energiebronnen en grondstoffen (of toch importeren uit China?)

lokale kennis en ervaringen

waarborging van kwaliteit?



(Kleinschalige) drinkwaterzuivering in ontwikkelingslanden

Uitdagingen voor de (civiel) ingenieur

College Inleiding Watermanagement

ir. Doris van Halem D.vanHalem@tudelft.nl

27 september 2007

24